

Raphaël Dupré

Univ. Paris-Saclay

Two Pictures of the Nucleus

Two ways to describe nuclei

- As an ensemble of nucleons
- As an ensemble of quarks and gluons

Traditional nuclear physics

- This picture is very effective
- Nuclear properties well reproduced
- Needs good NN and NNN forces

Do we need to go to quark and gluons ?

- Spoiler : we do !

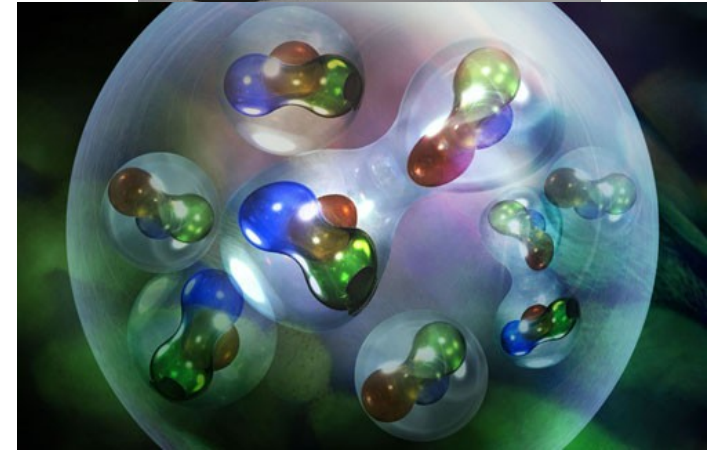
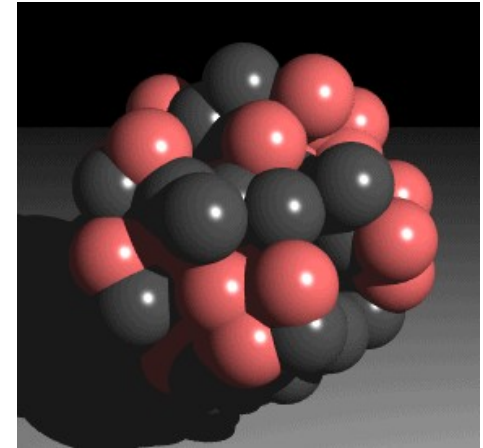

The Nucleus Quark Structure

The nuclear PDFs show many surprises

- Quarks are affected by the nuclear medium
- The EMC effect at large x , the shadowing effect at lower x
- The dependence of this effect appears to have complex dependence to nuclear density

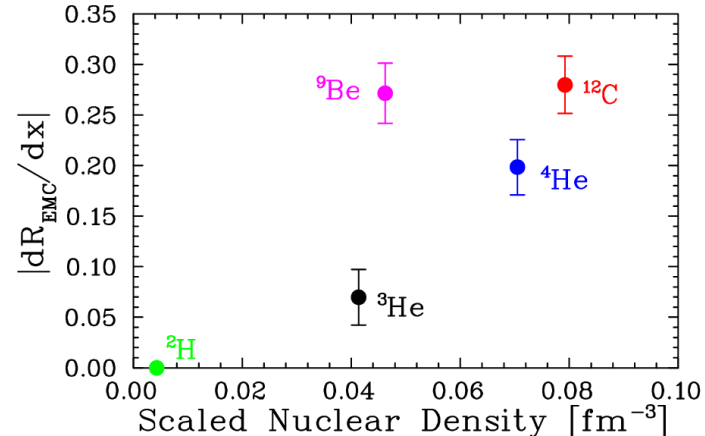
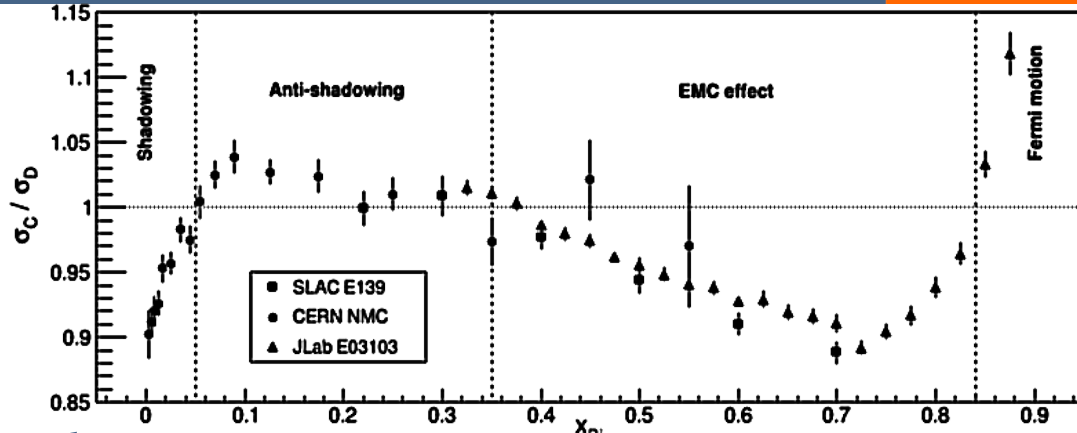

Measuring Nuclear DVCS

Nuclei give control over the spin

- Spin-0 \rightarrow 2 GPD ; Spin-1/2 \rightarrow 8 GPDs ; Spin-1 \rightarrow 18 GPDs
- Half of these intervene in DVCS

In the nucleus two processes

- Coherent and incoherent channels
 - Similar to elastic and quasi-elastic
- Probe the whole nucleus and the bound nucleons

A perfect tool to study the EMC effect

- Coherent DVCS gives access to the full nucleus
 - Including non-nucleonic degrees of freedom
- Incoherent DVCS gives access to the bound nucleon
 - To test modifications of the bound nucleon structure

R. Dupré and S. Scopetta. 3D Structure and Nuclear Targets. Eur. Phys. J., A52(6):159, 2016

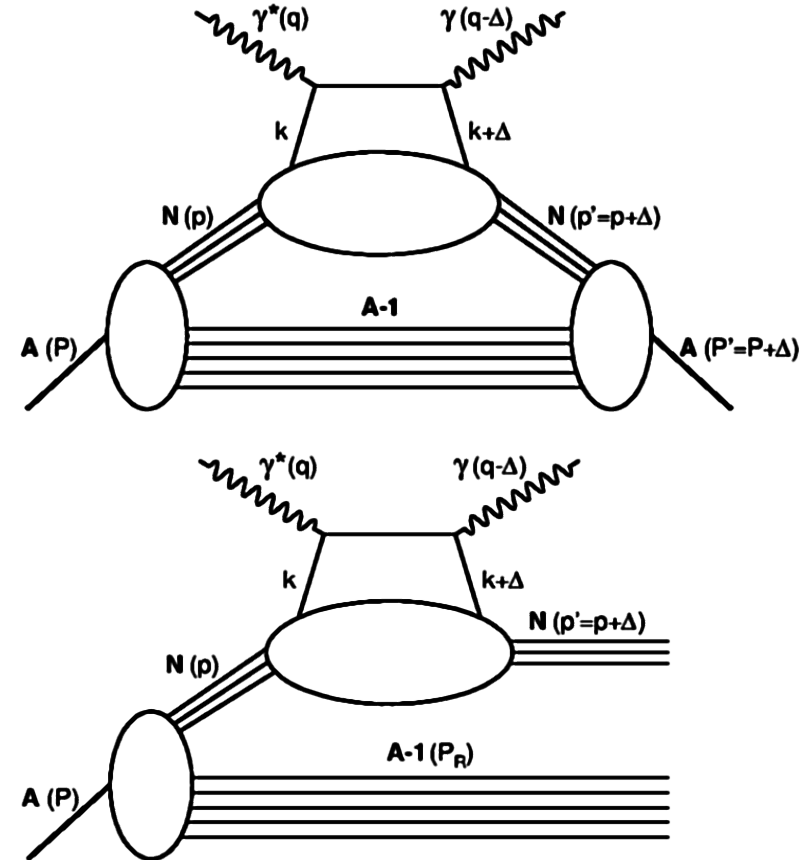

HERMES Results

Nuclear DVCS measurement by HERMES

- Charge and beam-spin asymmetries
- No clear nuclear dependence
- In a rather pure coherent sample

This is a problem...

- In the coherent process we expect a significant increase
- Argument about the way coherent and incoherent are separated

Can we measure it directly ?

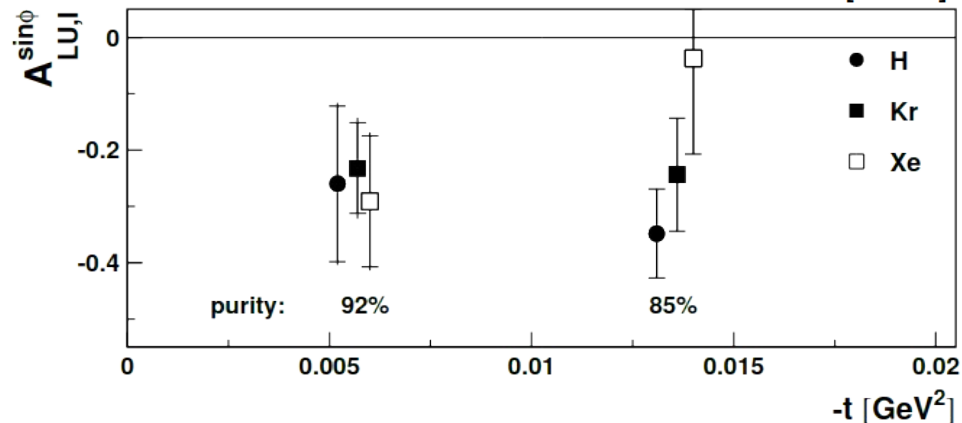
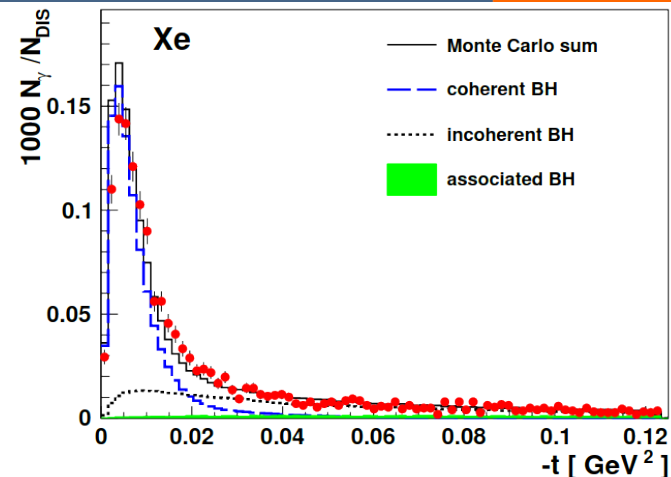

The CLAS experiment at JLab



Jefferson Laboratory

- 6 GeV electron beam (now 12 GeV)
- High stability, 100 % duty factor

The CLAS spectrometer

- 2 π acceptance
- Luminosity $\sim 10^{34} \text{ cm}^{-2}\text{s}^{-1}$
- Upgraded for DVCS measurements
 - A Low angle calorimeter for photons
 - A Solenoid to protect it from secondaries

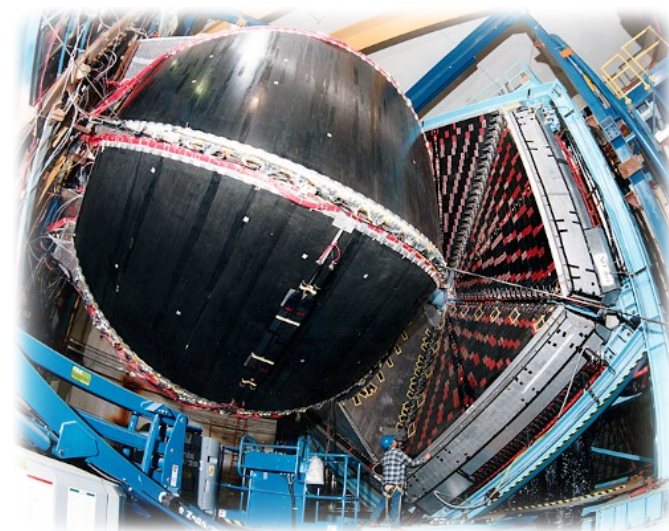

Detecting Recoil Nuclei

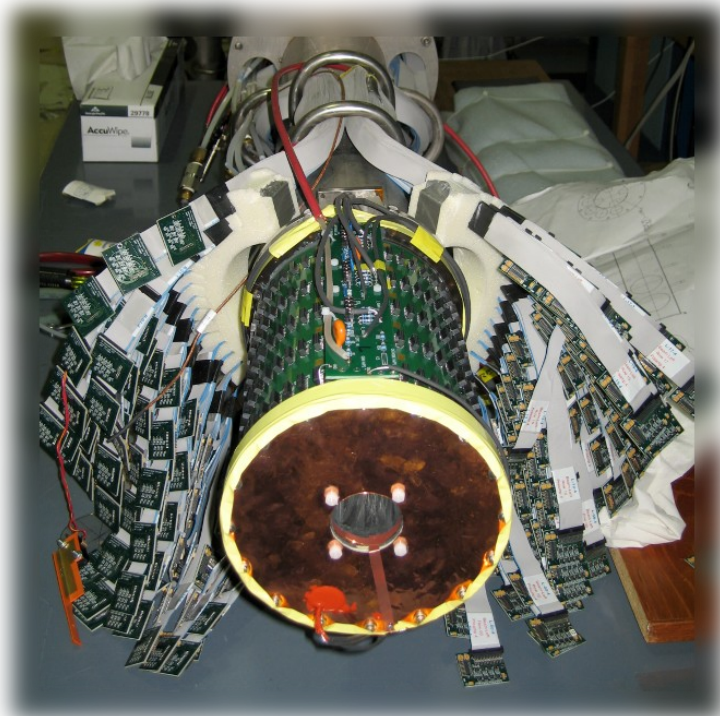

Recoil nuclei are evasive

- They usually do not make it out of the target...

How to handle that ?

- Use a light nuclei : Helium
 - It is also spin-0 which is nice for simplicity
- Use a light target : a straw
 - Filled at 5 Atm with 50 μm thick walls
- Get very close to it : Radial TPC
 - 3 cm away from the target

The experiment ran in 2009



The Coherent Helium DVCS

Coherent DVCS on helium

- Fully exclusive
- We observed large beam spin asymmetry
 - About twice the one on the proton, as expected from theory

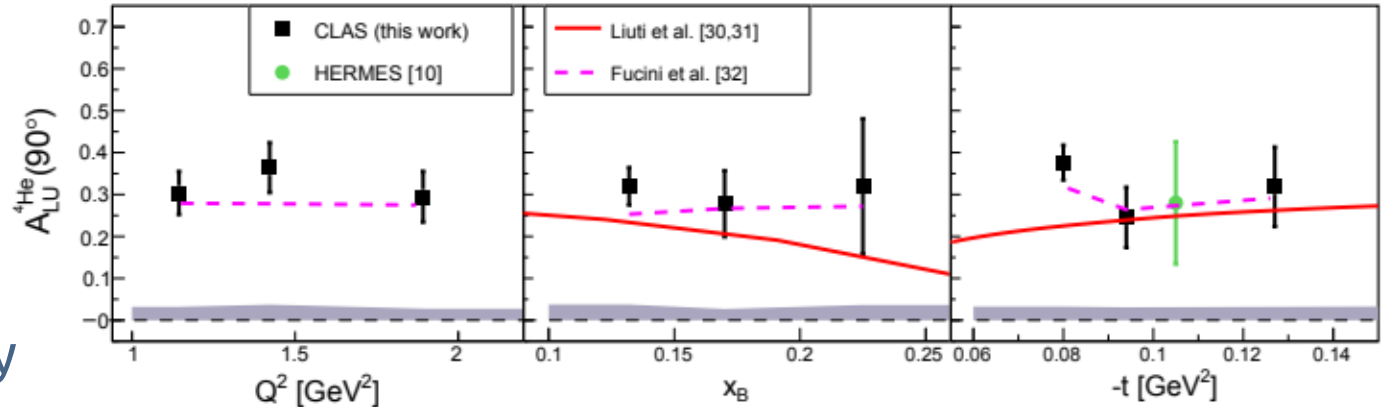

Interpretation of the results

- This strong signal shows we fully isolated coherent DVCS
- The amount of data is too little for advanced interpretation
- But enough to check if we can extract the CFF !

M. Hattawy et al. (CLAS Coll.) Phys. Rev. Lett., 119(20):202004, 2017.



Nuclear CFF Extraction

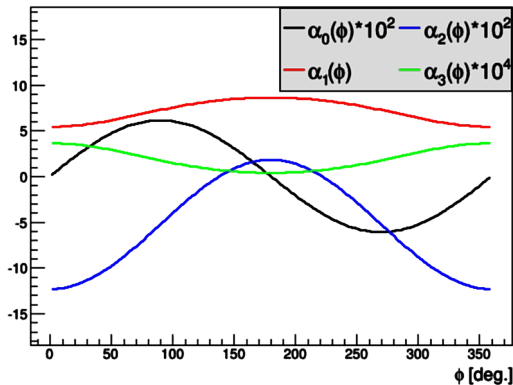
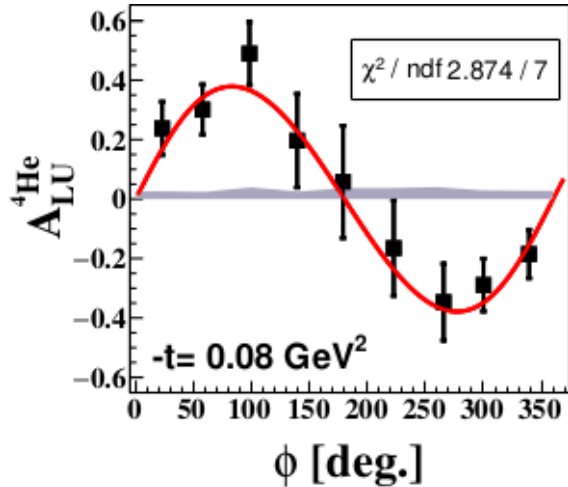

The Helium CFF extraction

- Simplified by the spin-0 (1 GPD/CFF)

This is done using the different contributions in phi

- They are calculable within pQCD

$$A_{LU}(\phi) = \frac{\alpha_0(\phi) \Im m(\mathcal{H}_A)}{\alpha_1(\phi) + \alpha_2(\phi) \Re e(\mathcal{H}_A) + \alpha_3(\phi) (\Re e(\mathcal{H}_A)^2 + \Im m(\mathcal{H}_A)^2)}$$

- The fit converges immediately

M. Hattawy et al. (CLAS Coll.) Phys. Rev. Lett., 119(20):202004, 2017.



(First) Model independent CFF extraction

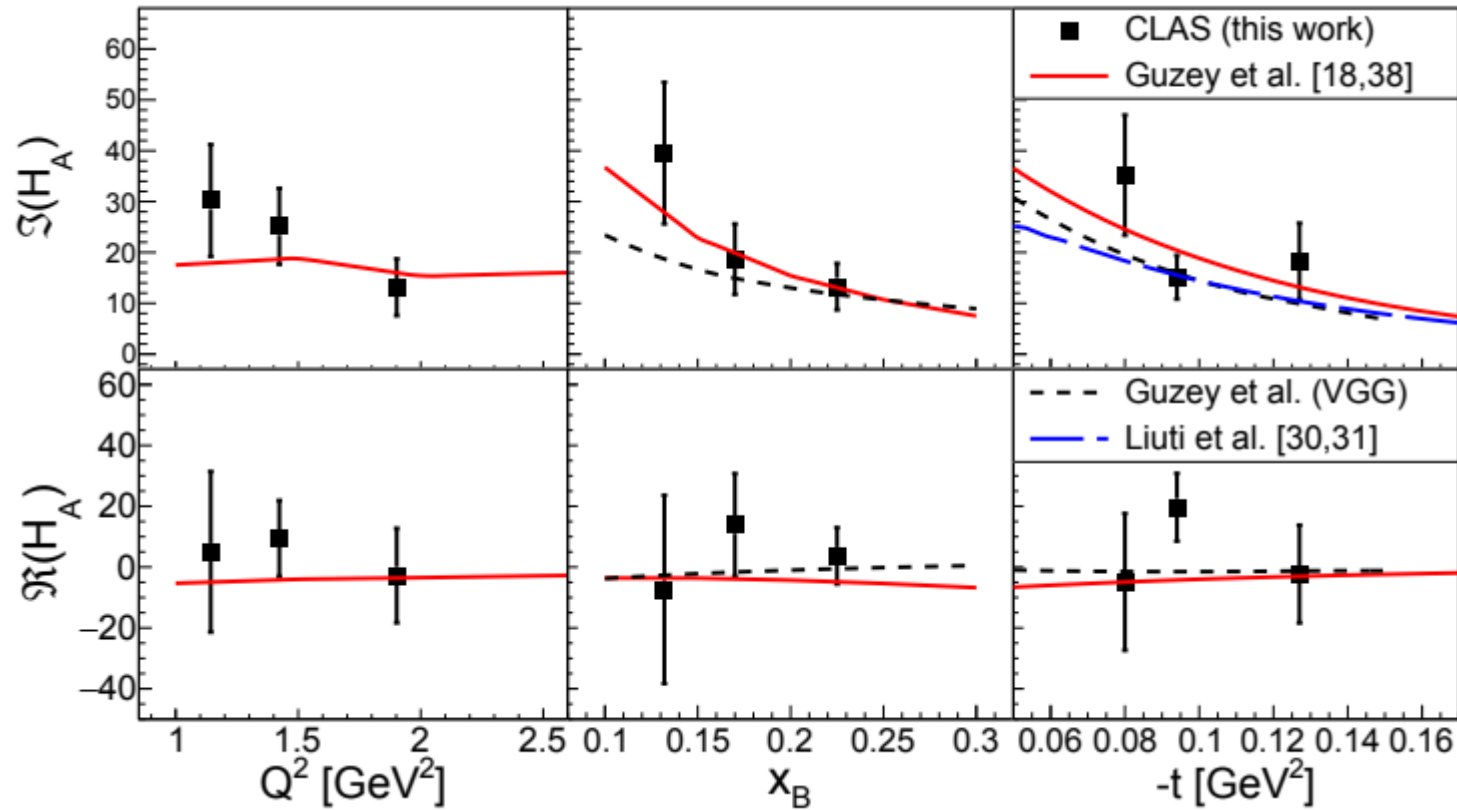

Incoherent Helium DVCS

Gives a "generalized" EMC

- Strongly suppressed in particular for anti-shadowing
- Strange behavior compared to the models

A New kind of EMC effect?

- It could be a nuclear effect
- Or it could be due to final state interactions
 - Can be very complicated in DVCS

M. Hattawy et al. (CLAS Coll.) Phys. Rev. Lett., 123(3):032502, 2019.

More work is ongoing on these questions

- On the theoretical side for a better description
- On the experimental side with nitrogen data

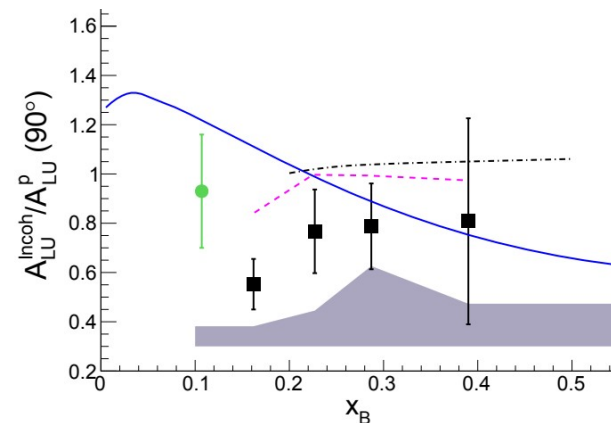
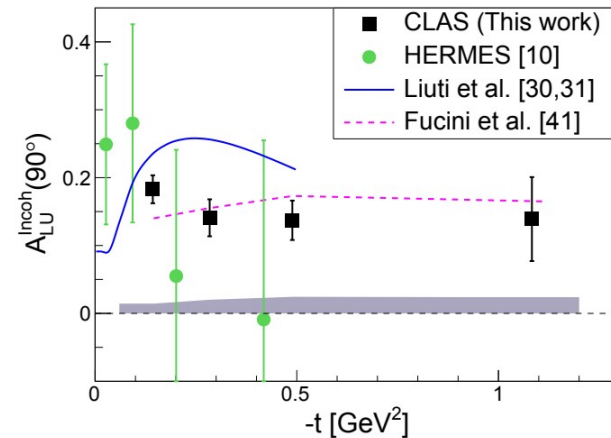

The ALERT Detector

A Low Energy Recoil Tracker

- Hyperbolic drift chamber
- Time-of-Flight array

It will be used for a large array of experiments

- Nuclear DVCS, DVMP...
- Tagged processes

Collaborative effort within CLAS12

- ANL, IJCLab, JLab, Mississippi SU, NMSU, and Temple
- We tested a prototype with a nuclear beam in the Fall at the ALTO facility (Orsay, France)

Scheduled for the Summer 2024

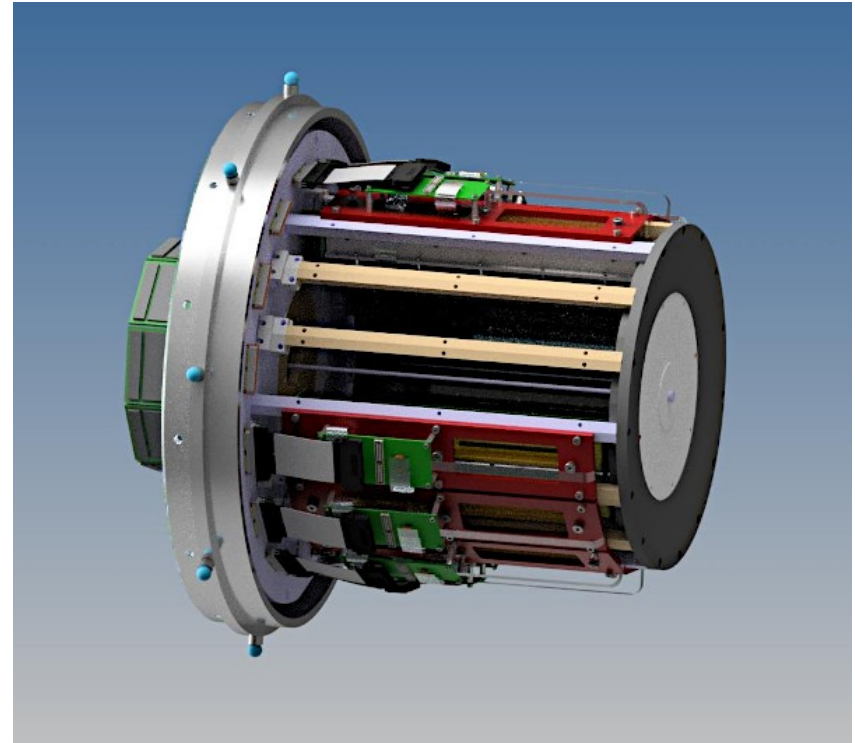

What results do we expect ?

Tomography of a nucleus

- A view into the nucleus in three dimensions
- Using the wider phase space and larger statistics

Extension to the gluons

- We will measure DVMP (Phi meson)
- We hope to obtain a similar result for gluon tomography

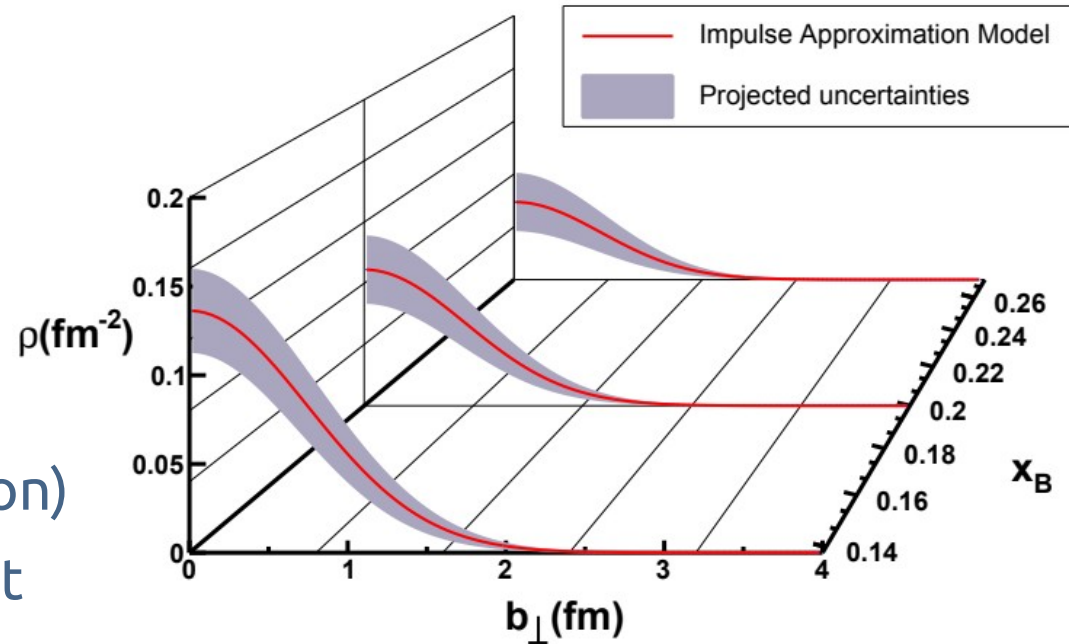

Tagging to Access Offshellness

Tagging connects EMC to nucleon kinematics

- Linked through virtuality of the nucleon
- Can differentiate mean field from SRC nucleons

This will test models and more

- Comparison between deuterium and helium
- It unequivocally resolve the link between the EMC effect and nucleon momentum

Different nuclei

- Cover different momentum ranges
- Mean field vs SRC

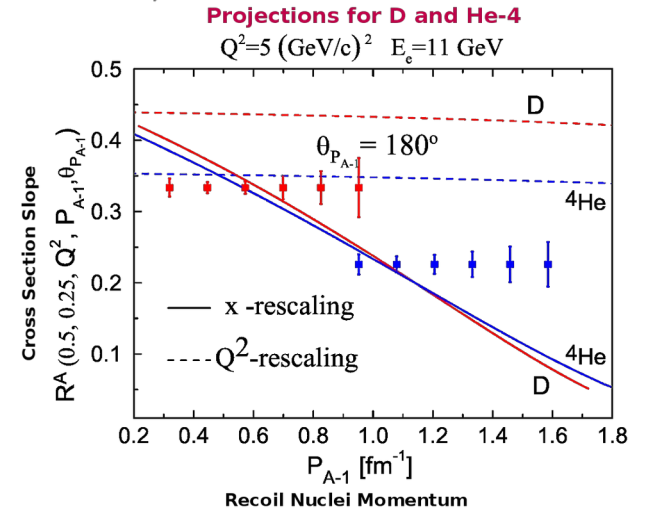
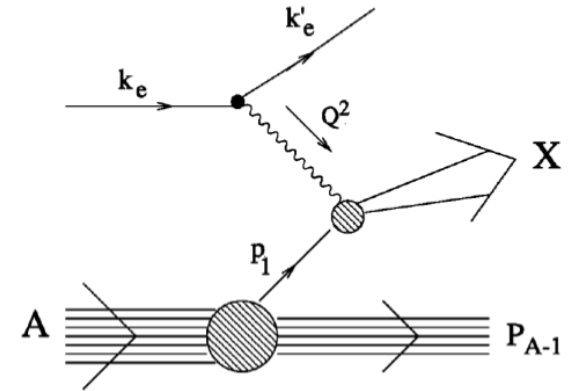

Understanding the Incoherent DVCS

Tagging the incoherent DVCS

- A tagged measurement can pin down the origin of the strong BSA suppression in incoherent DVCS
- By better controlling the initial and final states independently

Proposed for JLab 12 GeV

- This is probably an important addition for all incoherent processes in the future

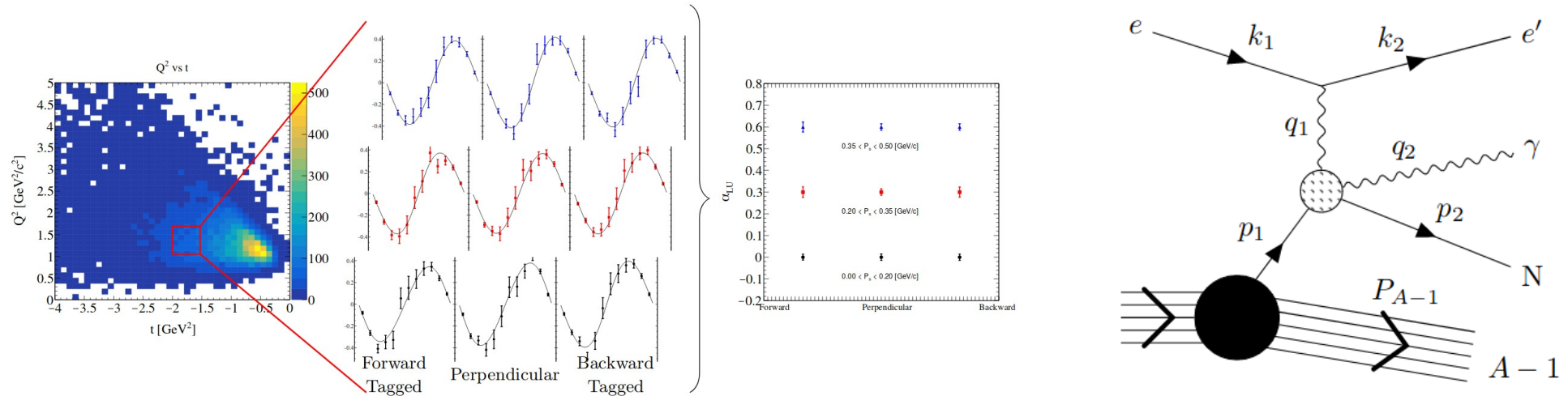

The EIC Project

We are preparing for nuclear DVCS at the EIC

- Measuring nuclear DVCS at much lower x
- Make a 3D image of the shadowing region

We developed a Monte-Carlo Event Generator

- ROOT based event generator use the T Foam class to generate a grid and then events
- Use of a recent model tested against data

Sara Fucini, Sergio Scopetta, Michele Viviani Phys.Rev.C 98 (2018) 1, 015203

- We named it TOPEG (The Orsay Perugia Event Generator)

<https://gitlab.in2p3.fr/dupre/nopeg>

These simulations were produced for the EIC Yellow Report (2021)

- Studies prolonged for the ECCE proposal
- New models are in the work for this event generator (tagged DVCS in particular)



EIC Projections

We expect very nice results from the EIC

- The key detector for this is the Roman pot
- Detecting the nuclear recoil very close to the beam line
- Here we show profile extractions
 - For transverse momentum thresholds of 0.1 (left), 0.2 (center) and 0.3 GeV (right)

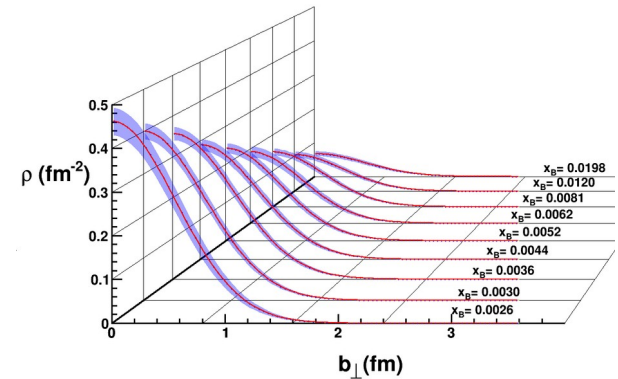
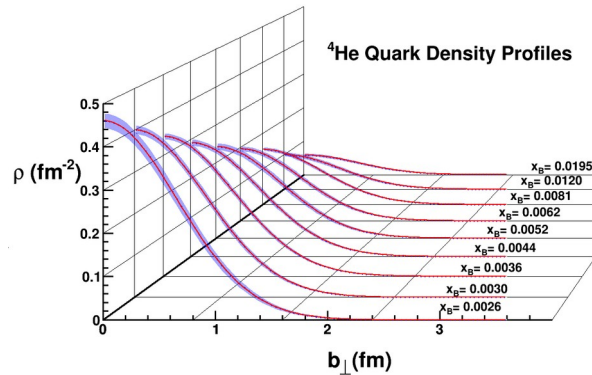
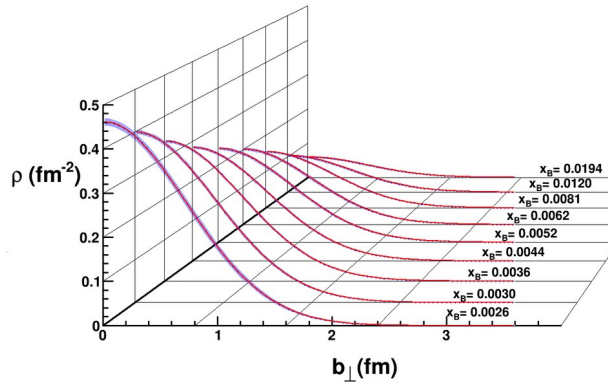

Much more GPD physics with exclusive meson productions

- Particularly sensitive to the gluon component



Summary

We do not understand the nucleus well within QCD

- Either we do not understand the mechanisms at play
- Or we lack a quantitative calculation to demonstrate it

There are many avenues, I focused here on nuclear GPDs

- We measured coherent and incoherent nuclear DVCS
 - **Confirming some of our understanding and raising new questions**
- More measurements are coming to reach high precision at JLab

Important new elements are coming, especially with EIC

- Using tagging will open many incoherent channels and control the virtuality
- The high energy gives access to a completely new x range and gluons

