

Spectator tagging with polarized deuteron: Observables and applications

C. Weiss, Electron-Nuclei Interaction at EIC, CNF Stony Brook, 6-7 July 2023

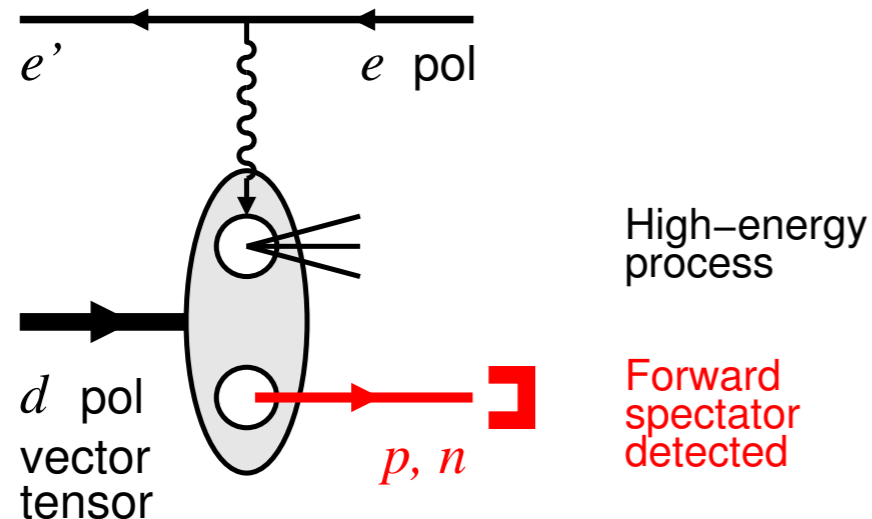

Polarized light ions

Physics objectives

Controlling nuclear configurations

Spectator tagging with polarized deuteron

Cross section $e + d(pol) \rightarrow e' + X + p(n)$

Deuteron x nucleon structure

Spin observables

Applications

Vector L: Effective neutron polarization

Tensor L: Maximum tensor polarization

More: Vector T, small-x shadowing, ...

Basic idea: Use spectator momentum to control nuclear configurations during high-energy process

- relative momentum, spatial size
- interactions, non-nucleonic DoF
- nucleon polarization, S/D wave

Frankfurt, Strikman, NPA 405, 557 (1983)

JLab LDRD 2014-15

Cosyn, Weiss, PLB 799, 135035 (2019), PRC 102 065204 (2020) + in progress

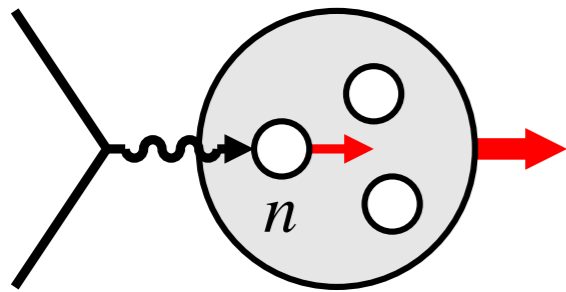

Neutron spin structure

Flavor decomposition of quark PDFs/spin, GPDs, TMDs
Singlet-nonsinglet separation in QCD evolution for ΔG

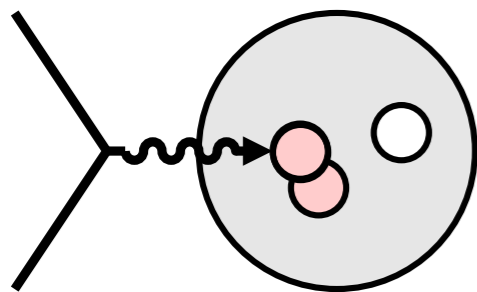

Nuclear interactions

Hadronic: Short-range correlations, NN core, non-nucleonic DoF
Partonic: Nuclear modification of partonic structure
EMC effect $x > 0.3$, antishadowing $x \sim 0.1$
Quarks/antiquarks/gluons? Spin, flavor? Dynamical mechanism?

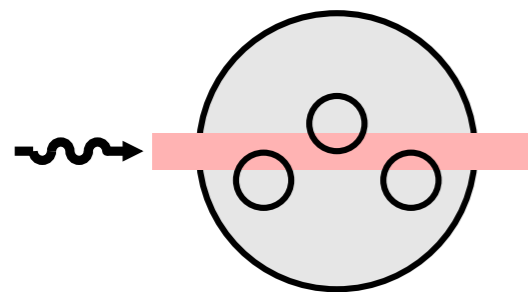

Coherent phenomena

Nuclear shadowing $x \ll 0.1$
Buildup of coherence, interaction with 2, 3, 4... nucleons?
 \leftrightarrow Shadowing and saturation in heavy nuclei

[Nucleus rest frame view]

Common challenge: Effects depend on nuclear configuration during high-energy process. Main limiting factor.

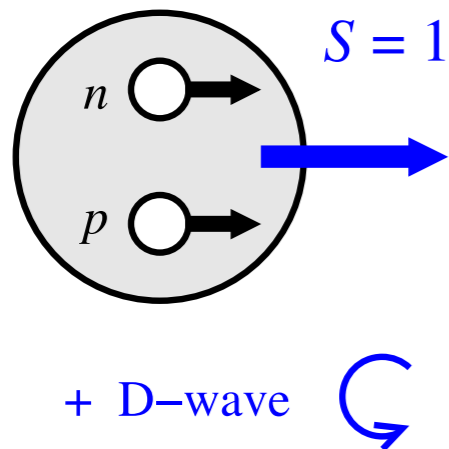

Deuteron as simplest system

Nucleonic wave function simple, well known ($p \sim < 400$ MeV)

Nucleons spin-polarized, some D-wave depolarization

Intrinsic Δ isobars suppressed by Isospin = 0

Large Δ component in ^3He Bissey, Guzey, Strikman, Thomas 2002

Spectator nucleon tagging

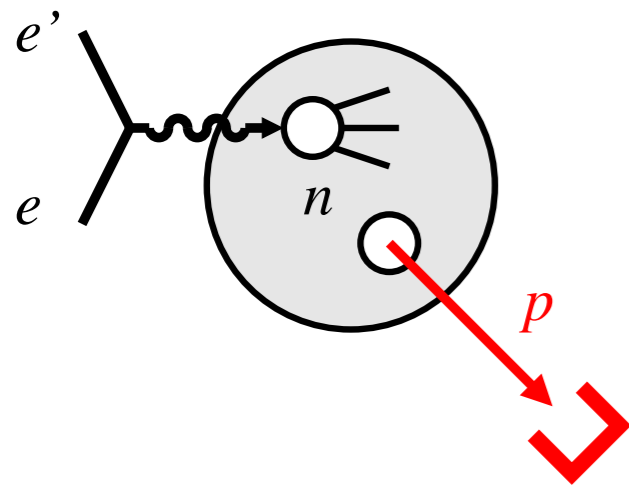

[Nucleus rest frame view]

Identifies active nucleon

Controls configuration through recoil momentum:
spatial size \rightarrow interactions, S/D wave \rightarrow polarization

Average configurations \sim few 10 – 100 MeV

Small-size configurations \sim 200-500 MeV

Fixed-target experiments: JLab BONuS 6/12 GeV,
ALERT (protons), BAND (neutrons)

[→ Talk Kuhn](#)

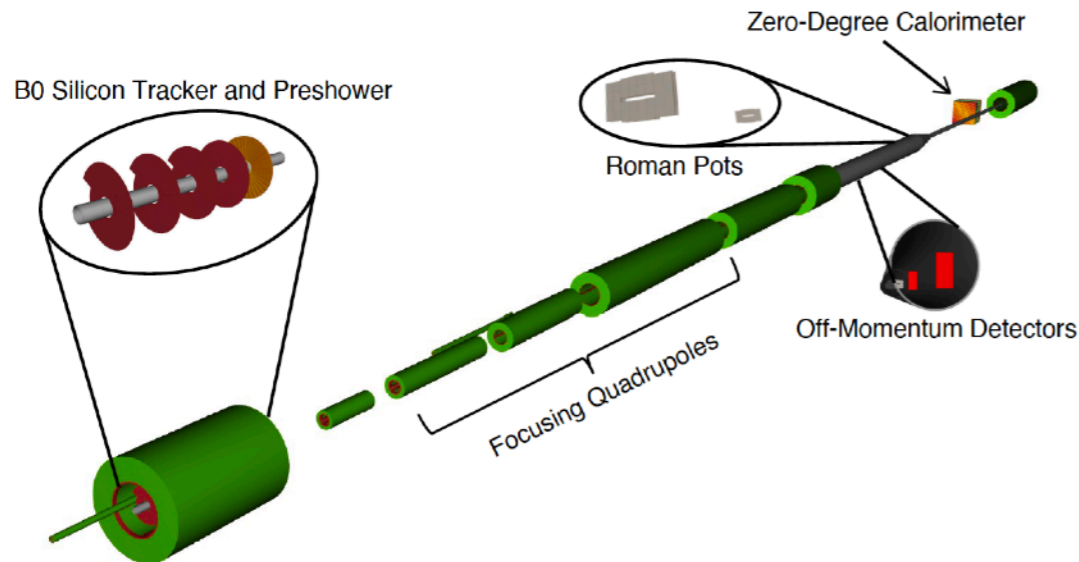

Far-forward detectors

Magnetic spectrometer for protons, several subsystems: good acceptance and resolution

Zero-Degree Calorimeter for neutron

Advantage over fixed target: No target material, can detect spectators with rest frame momenta \rightarrow zero

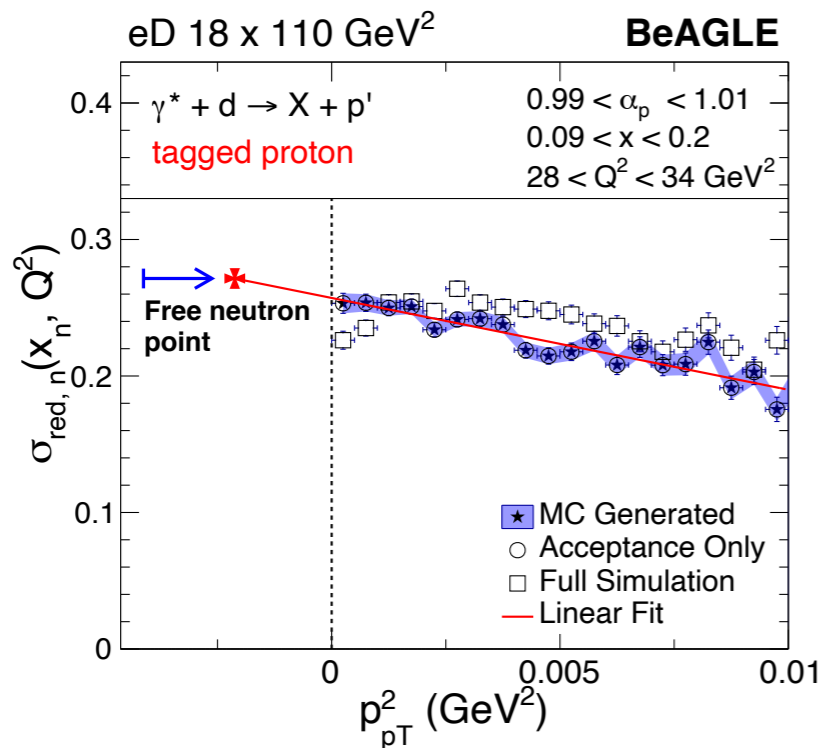

Physics-detector simulations

Free neutron structure from proton tagging and pole extrapolation
Jentsch, Tu, Weiss, PRC 104, 065205 (2021)

Configuration dependence of EMC effect from proton and neutron tagging
in progress

Method works... can we extend it to polarized deuteron?

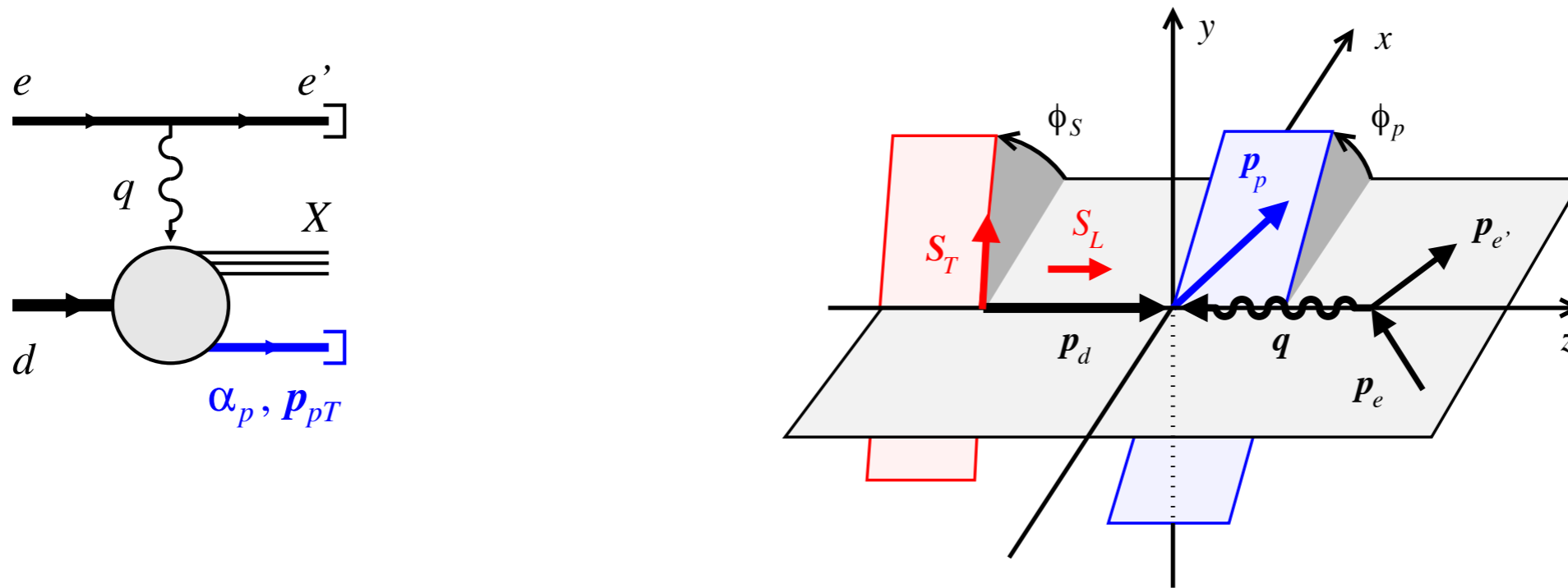

$$\frac{d\sigma}{dx dQ^2 (d^3 p_p / E_p)} = \text{Flux} \times \sum \text{Kin}(y) \times F_d(x, Q^2; \alpha_p, p_{pT}) \times \text{Harmonic}(\phi_p)$$

+ spin dependence

Semi-inclusive cross section $e + d \rightarrow e' + X + p$ (or n)

Collinear frame: Virtual photon and deuteron momenta collinear $\mathbf{q} \parallel \mathbf{p}_d$, along z-axis

Proton recoil momentum described by light-cone components: $p_p^+ = \alpha_p p_d^+ / 2$, \mathbf{p}_{pT}
 Related in simple way to rest-frame 3-momentum

Here: No assumption re composite nuclear structure, $A = \sum N$, or similar!

$$\sigma = \sum_{\lambda, \lambda'} \rho_{\lambda\lambda'} \langle d, \lambda' | \dots | d, \lambda \rangle$$

$$F_U = F_{UU,T} + \epsilon F_{UU,L} + \sqrt{2\epsilon(1+\epsilon)} \cos \phi_h F_{UU}^{\cos \phi_h} + \epsilon \cos 2\phi_h F_{UU}^{\cos 2\phi_h} + h\sqrt{2\epsilon(1-\epsilon)} \sin \phi_h F_{LU}^{\sin \phi_h}$$

$$F_S = S_L \left[\sqrt{2\epsilon(1+\epsilon)} \sin \phi_h F_{USL}^{\sin \phi_h} + \epsilon \sin 2\phi_h F_{USL}^{\sin 2\phi_h} \right]$$

$$+ S_L h \left[\sqrt{1-\epsilon^2} F_{LSL} + \sqrt{2\epsilon(1-\epsilon)} \cos \phi_h F_{LSL}^{\cos \phi_h} \right]$$

$$+ S_\perp \left[\sin(\phi_h - \phi_S) \left(F_{UST,T}^{\sin(\phi_h - \phi_S)} + \epsilon F_{UST,L}^{\sin(\phi_h - \phi_S)} \right) + \epsilon \sin(\phi_h + \phi_S) F_{UST}^{\sin(\phi_h + \phi_S)} \right]$$

$$+ \epsilon \sin(3\phi_h - \phi_S) F_{UST}^{\sin(3\phi_h - \phi_S)} + \sqrt{2\epsilon(1+\epsilon)} \left(\sin \phi_S F_{UST}^{\sin \phi_S} + \sin(2\phi_h - \phi_S) F_{UST}^{\sin(2\phi_h - \phi_S)} \right) \Big]$$

$$+ S_\perp h \left[\sqrt{1-\epsilon^2} \cos(\phi_h - \phi_S) F_{LST}^{\cos(\phi_h - \phi_S)} + \right.$$

$$\left. \sqrt{2\epsilon(1-\epsilon)} \left(\cos \phi_S F_{LST}^{\cos \phi_S} + \cos(2\phi_h - \phi_S) F_{LST}^{\cos(2\phi_h - \phi_S)} \right) \right], \quad \text{Here } \phi_h \equiv \phi_p$$

$$F_T = T_{LL} \left[F_{UTLL,T} + \epsilon F_{UTLL,L} + \sqrt{2\epsilon(1+\epsilon)} \cos \phi_h F_{UTLL}^{\cos \phi_h} + \epsilon \cos 2\phi_h F_{UTLL}^{\cos 2\phi_h} \right]$$

$$+ T_{LL} h \sqrt{2\epsilon(1-\epsilon)} \sin \phi_h F_{LTLL}^{\sin \phi_h}$$

$$+ T_{L\perp} [\dots] + T_{L\perp} h [\dots]$$

$$+ T_{\perp\perp} \left[\cos(2\phi_h - 2\phi_{T\perp}) \left(F_{UTTT,T}^{\cos(2\phi_h - 2\phi_{T\perp})} + \epsilon F_{UTTT,L}^{\cos(2\phi_h - 2\phi_{T\perp})} \right) \right]$$

$$+ \epsilon \cos 2\phi_{T\perp} F_{UTTT}^{\cos 2\phi_{T\perp}} + \epsilon \cos(4\phi_h - 2\phi_{T\perp}) F_{UTTT}^{\cos(4\phi_h - 2\phi_{T\perp})}$$

$$+ \sqrt{2\epsilon(1+\epsilon)} \left(\cos(\phi_h - 2\phi_{T\perp}) F_{UTTT}^{\cos(\phi_h - 2\phi_{T\perp})} + \cos(3\phi_h - 2\phi_{T\perp}) F_{UTTT}^{\cos(3\phi_h - 2\phi_{T\perp})} \right) \Big]$$

$$+ T_{\perp\perp} h [\dots]$$

Cosyn, Weiss, PRC102 (2020) 065204 + in preparation (2023)

Invariant formulation, suitable for collider and fixed-target

General result, valid for any spin-1 target

Deuteron polarization

Spin-1 density matrix $\rho_{\lambda'\lambda}(S, T)$

3 vector, 5 tensor parameters

Fixed by beam polarization measurements

Polarized cross section

Average with deuteron spin density matrix

U + S + T structures

U + S cross section has same form and ϕ_p -dep as for spin-1/2 target

Bacchetta et al 2007

T cross section has 23 new structures, some with ϕ_p -dep unique to T polarization

Integration over tagged proton momentum:
Recover inclusive tensor-polarized structures $b_1 \dots b_4$

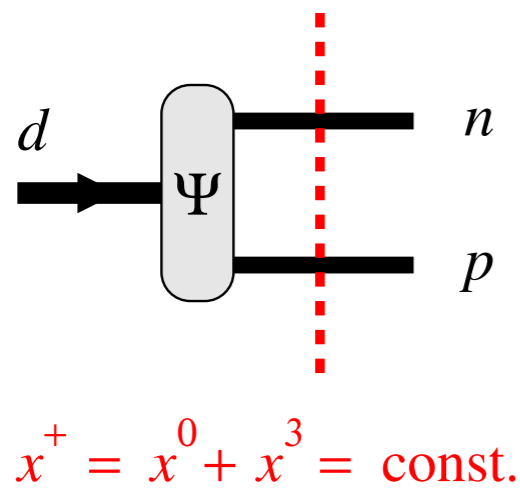

Deuteron light-front structure

pn wave function at fixed light-front time $x^+ = x^0 + x^3$

Permits matching with high-energy/DIS processes on nucleon [Frankfurt, Strikman 80s]

Contains low-energy nuclear structure ← NN interactions

Polarized deuteron light-front wave function

Spins described by light-front helicity states

Light-front WF constructed from 3D WF in pn CM frame, including transformation of spin states (Melosh rotation)

$$\Psi_d(\alpha_p, \mathbf{p}_{pT}; \lambda_p, \lambda_n | \lambda_d)$$

↑ light-front helicity

$$\Psi_d(\mathbf{k}; \sigma_p, \sigma_n | \sigma_d)$$

canonical spin

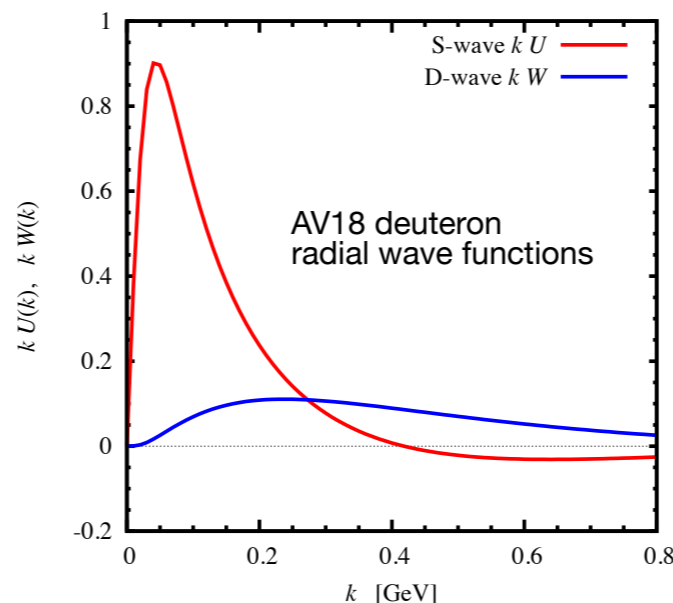

Contains S and D waves

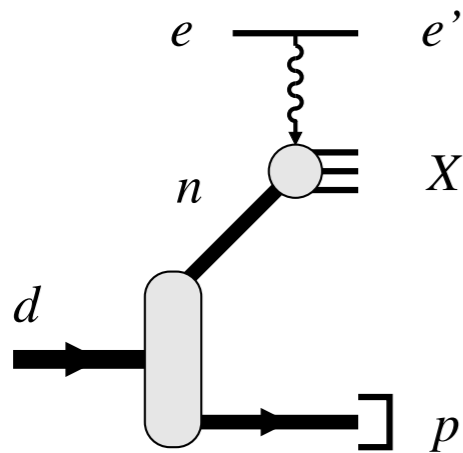

Impulse approximation

Spectator and DIS final state evolve independently

$$d\sigma[ed \rightarrow e'Xp] = S_d(\alpha_p, p_{pT}) d\Gamma_p \times d\sigma[en \rightarrow e'X]$$

$$S_d(\alpha_p, p_{pT}) = \text{Flux}(\alpha_p) \times |\Psi_d(\alpha_p, p_{pT})|^2 \quad \text{spectral function}$$

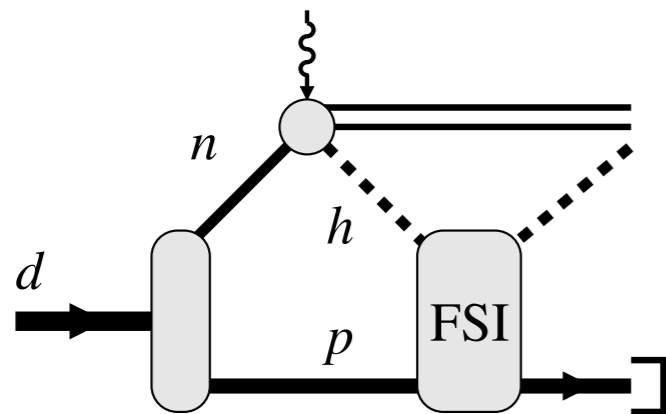

Final-state interactions

Part of DIS final state interacts with spectator, transfers momentum

Requires theoretical modeling → later

For DIS in scaling regime $\nu, Q^2 \rightarrow \infty$: These approximations are consistent with leading twist factorization of $\sigma[eN]$, partonic sum rules, etc.

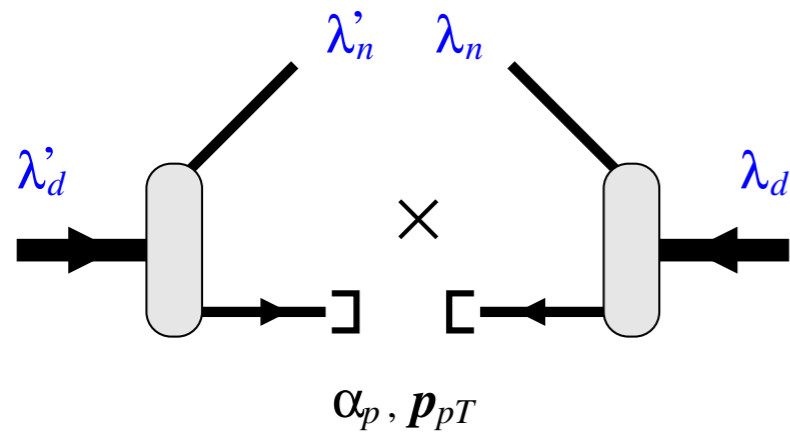

Deuteron spectral function

Describes distribution of neutrons depending on tagged proton momentum α_p, p_{pT}

Depends on deuteron and neutron spin

Satisfies momentum and spin sum rules

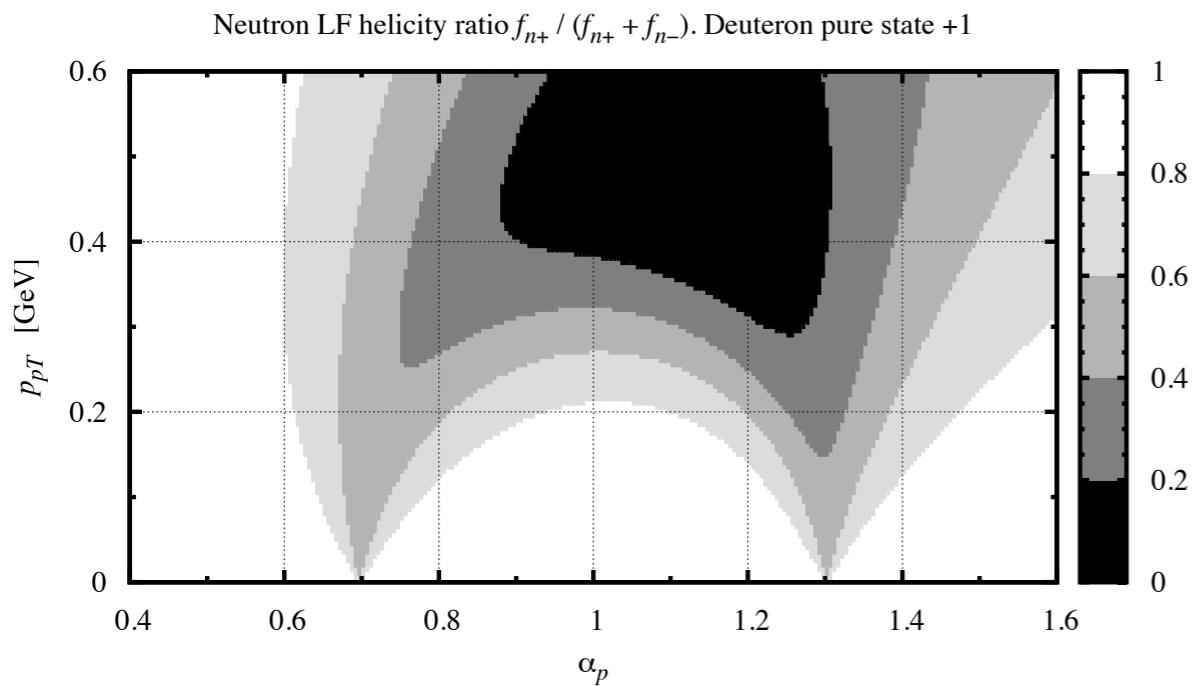

Neutron polarization in deuteron

Effective neutron polarization depends on tagged proton momentum: S vs D wave

Example: Deuteron in pure spin state +1.

Plot shows probability that neutron has helicity +1/2 i.e. is polarized along deuteron spin direction

Tagged proton momentum controls effective neutron polarization!

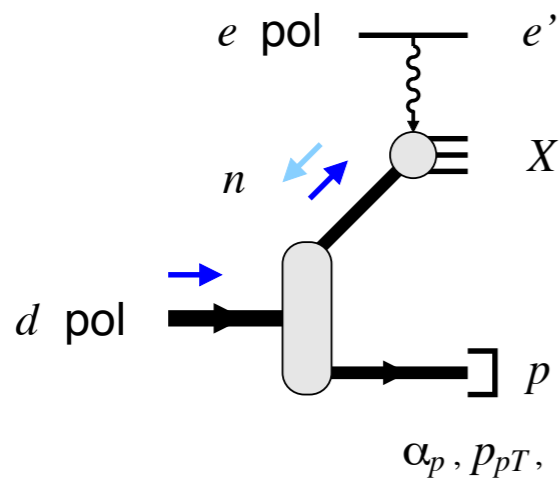

$A_{\parallel,d}(x_n, Q^2; \alpha_p, p_{pT})$ tagged longitud double spin asymmetry

$$= \frac{d\sigma_{\parallel}(+\frac{1}{2}, +1) - d\sigma_{\parallel}(-\frac{1}{2}, +1) - d\sigma_{\parallel}(+\frac{1}{2}, -1) + d\sigma_{\parallel}(-\frac{1}{2}, -1)}{d\sigma_{\parallel}(+\frac{1}{2}, +1) + d\sigma_{\parallel}(-\frac{1}{2}, +1) + d\sigma_{\parallel}(+\frac{1}{2}, -1) + d\sigma_{\parallel}(-\frac{1}{2}, -1)}$$

$$= \underbrace{\frac{S_d(\alpha_p, p_{pT})[S]}{S_d(\alpha_p, p_{pT})[U + T]}}_{D_d(\alpha_p, p_{pT})} A_{\parallel,n}(x_n, Q^2)$$



$D_d(\alpha_p, p_{pT})$

effective neutron polarization, depends on tagged proton momentum

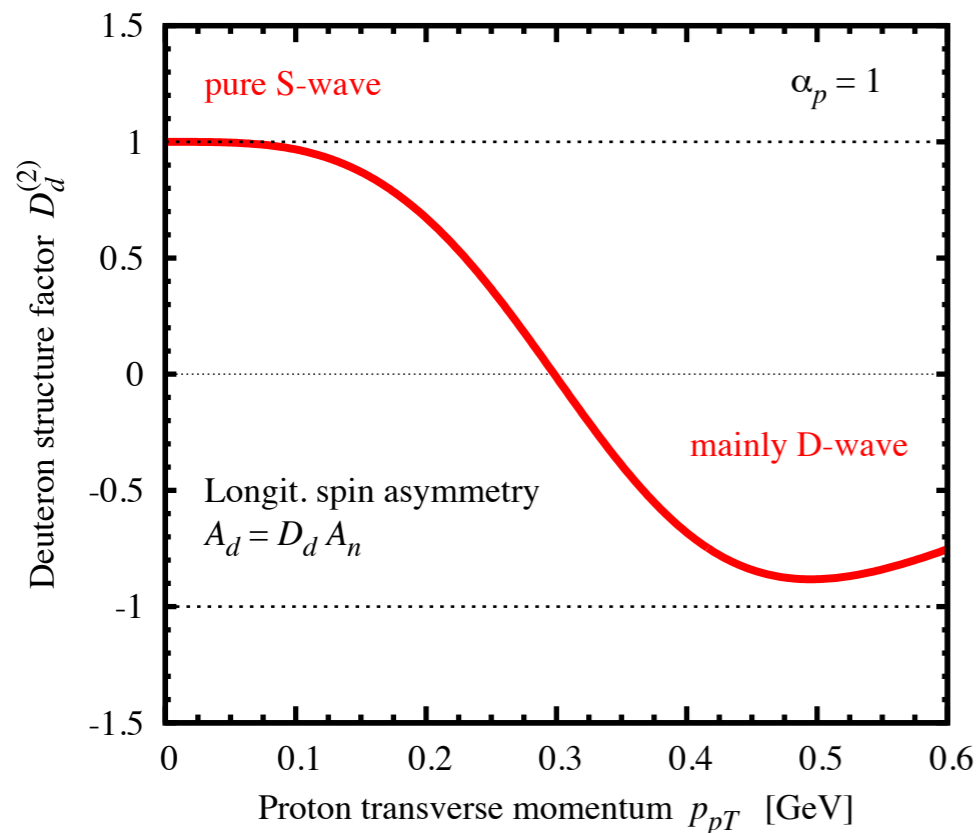

D wave drops out at $\mathbf{p}_{pT} = 0$:

Pure S-wave, neutron 100% polarized

D wave dominates at $\mathbf{p}_{pT} \sim 400$ MeV:

Neutron polarized opposite to deuteron spin!

Tagged proton momentum controls effective neutron polarization in deuteron

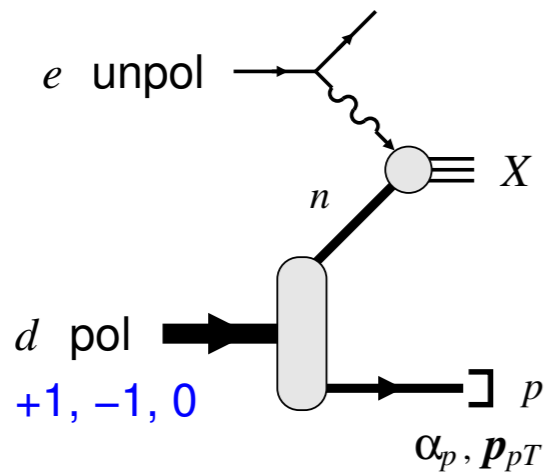

$A_{zz,d}(x, Q^2; \alpha_p, \mathbf{p}_{pT})$ tagged tensor polarized asymmetry

$$= \frac{d\sigma(+1) + d\sigma(-1) - 2d\sigma(0)}{d\sigma(+1) + d\sigma(-1) + d\sigma(0)} \quad -2 < A_{zz,d} < 1$$

$$= \frac{S_d(\alpha_p, p_{pT})[T_{LL}]}{S_d(\alpha_p, p_{pT})[U]} \quad \text{effective tensor polarization, depends on tagged momentum}$$

$$= \frac{\frac{1}{\sqrt{2}}UW + \frac{1}{4}W^2}{U^2 + W^2} \times \text{Angular} \quad \text{requires D-wave}$$

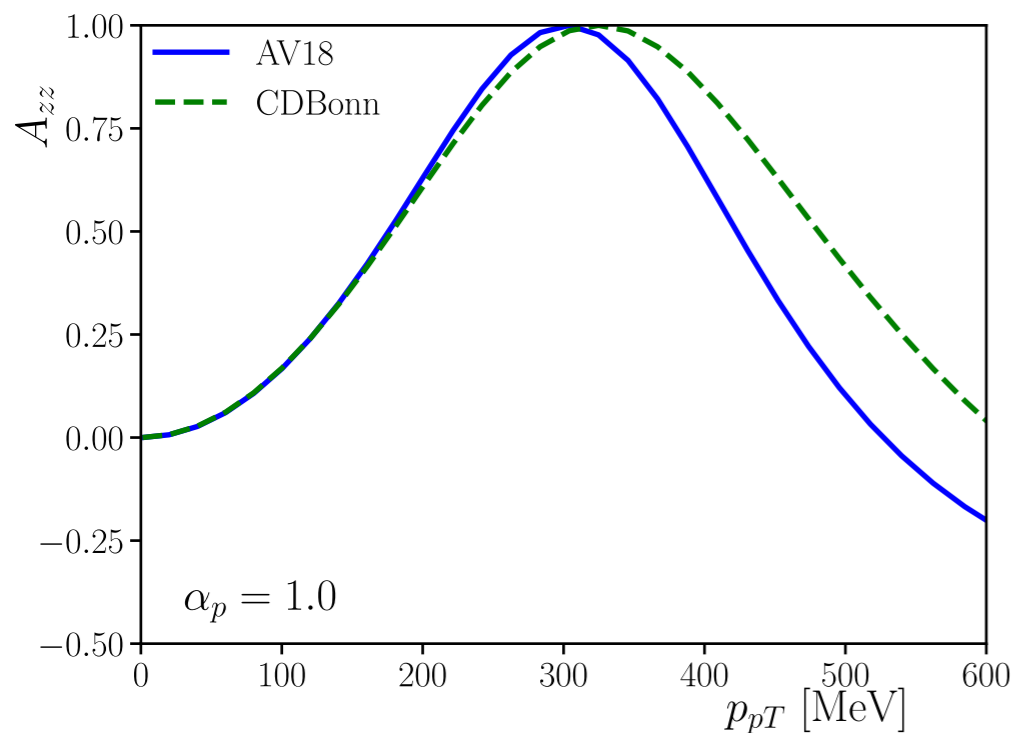

Maximal tensor polarization $A_{zz} = 1$
can be achieved at $p_{pT} \approx 300$ MeV and $\alpha_p = 1$

Much larger tensor asymmetry than in untagged scattering where most events come from nucleon momenta \sim few 10 MeV and D-wave is small

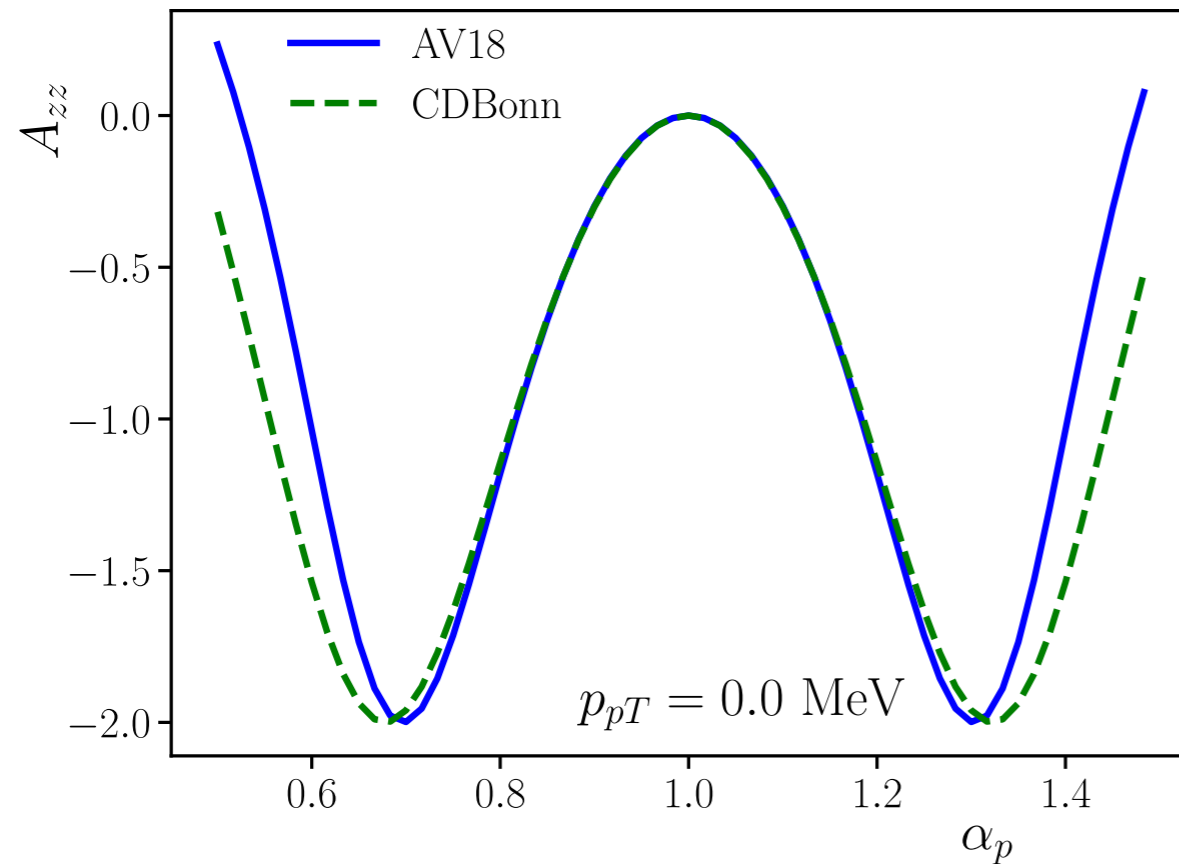

Tensor polarization $A_{zz} = -2$
achieved at $p_{pT} = 0$ and $\alpha_p - 1 \approx \pm 0.3$

Spectator tagging can realize tensor
asymmetries $O(1)$ through control
of S/D wave ratio

Frankfurt, Strikman 1983

Cosyn, Weiss, in progress

Transverse vector polarization of deuteron

Induces transverse nucleon polarization (transversity)
deforms longitudinal nucleon polarization (spin-orbit)

Tagged measurements of g_{2n} neutron spin structure function?
Challenge for light-front method. Involves “bad components” of EM current

Polarization effects in shadowing at small x

Deuteron tensor polarization controls alignment of nucleons
along reaction axis → probability of multiple scattering,
shadowing at small x

Final-state interactions

Large effects at $p_{pT} > 300$ MeV, should be included in calculations of tagged spin observables

Description based on space-time picture in deuteron rest frame: Fast and slow hadrons

Strikman, Weiss PRC97 (2018) 035209

ϕ_p dependent tagged cross section includes T-odd structures: Zero in impulse approximation,
require final state interactions, can provide sensitive tests (→ Sivers effect in SIDIS)

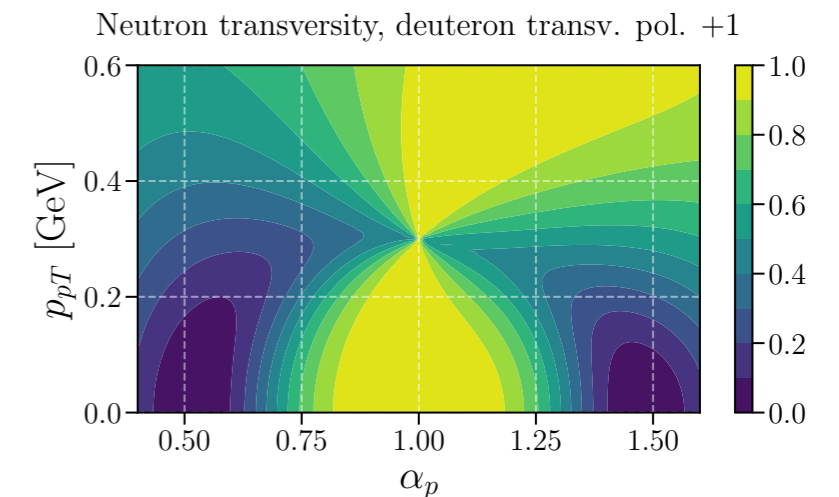
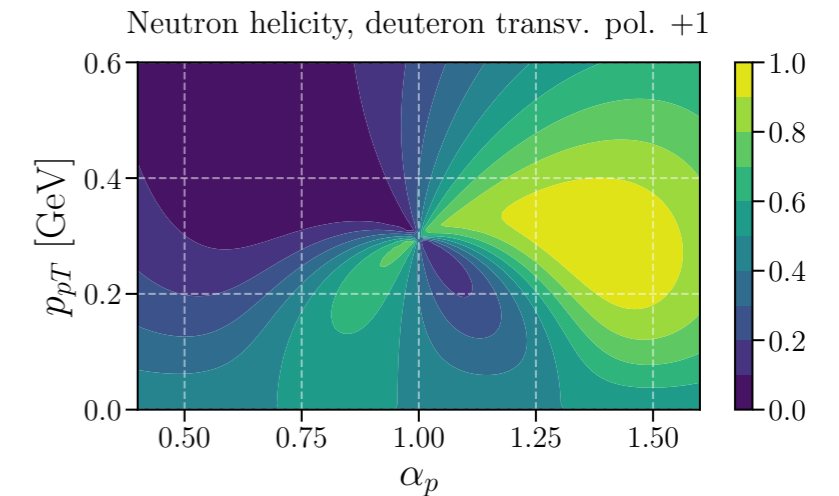

Cosyn, Weiss, in progress

Spectator tagging with deuteron permits control of nuclear configuration in high-energy process and differential analysis of nuclear effects — new opportunities, new challenges for theory & experiment

Spectator tagging with EIC far-forward detectors simulated in unpolarized DIS, shown to be feasible at spectator momenta $p_{pT} \lesssim 200$ MeV, limited by rates/luminosity at larger p_{pT}

Spectator tagging with polarized deuteron controls S/D ratio and would enable unique applications:

- Control/reverse effective neutron polarization
- Achieve tensor polarization $O(1)$

Practical challenges at EIC:

- Polarization of deuteron beam
- Luminosity requirements for spin asymmetries + tagging

Tensor-polarized asymmetries appear as best option: Electron unpolarized, asymmetries $O(1)$, unpolarized nucleon cross sections cancel. Should be simulated!

Supplemental material

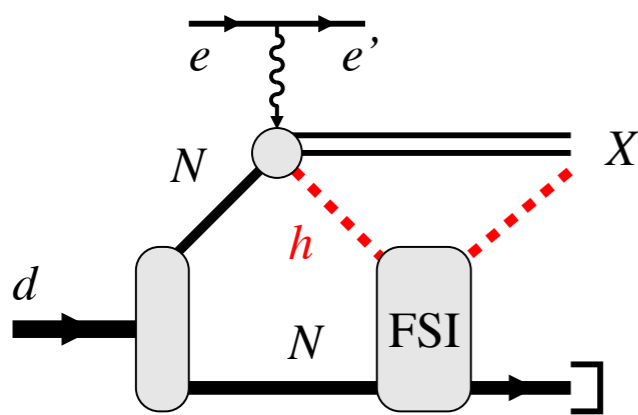

Part of final state of high-energy process interacts with spectator

Changes spectator momentum distribution,
no effect on total cross section (closure)

What final states are produced? How do they interact?
Depends on specifics of high-energy process

Kinematic regimes and mechanisms

DIS, $x \gtrsim 0.1$

h = target fragmentation hadrons
on-shell rescattering

Ciofi degli Atti, Kaptari, Kopeliovich 2004+
Strikman, Weiss 2018

DIS, $x \ll 0.1$

h = diffractive nucleons
QM rescattering, interplay of coherent
and incoherent channels

Guzey, Strikman, Weiss, in progress

Finite W, Q^2
(JLab 6/12 GeV)

$X = \sum N^*$ resonances
challenge to implement coherence,
color transparency

Cosyn, Sargsian, Melnitchouk 2011/14
Cosyn, Sargsian 2017

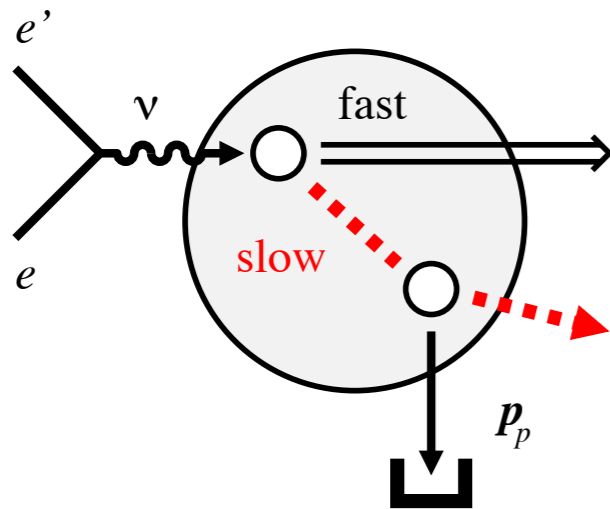

Space-time picture in deuteron rest frame

Strikman, Weiss PRC97 (2018) 035209

$\nu \gg$ hadronic scale: Large phase space for hadron production

“Fast” hadrons $E_h = \mathcal{O}(\nu)$ – current fragmentation region:
Formed outside nucleus, interaction with spectator suppressed

“Slow” hadrons $E_h = \mathcal{O}(1 \text{ GeV}) \ll \nu$ – target fragmentation region:
Formed inside nucleus, interact with hadronic cross sections
Source of FSI in tagged DIS!

Picture respects QCD factorization of target fragmentation:
FSI only modifies soft breakup of target, does not cause
long-range rapidity correlations

[Deuteron rest frame view]

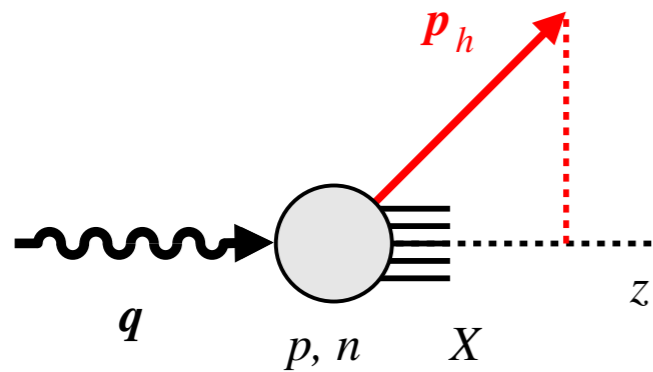

Studied distributions of slow hadrons in DIS on nucleon
 – target fragmentation

Described by light-cone variables
 Constrained by light-cone momentum conservation

Used experimental distributions: HERA, EMC, neutrino DIS

Need better data on target fragmentation: JLab12, EIC!

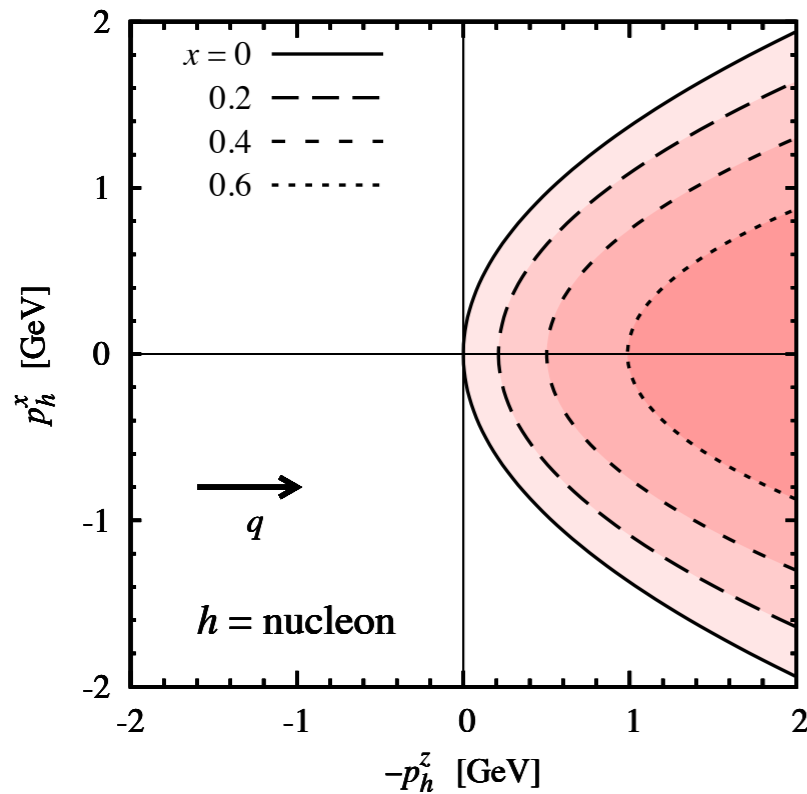

Momentum distribution of slow hadrons in nucleon rest frame: Cone in virtual photon direction

Strikman, Weiss PRC97 (2018) 035209

Hadron x_F distributions EMC 1986

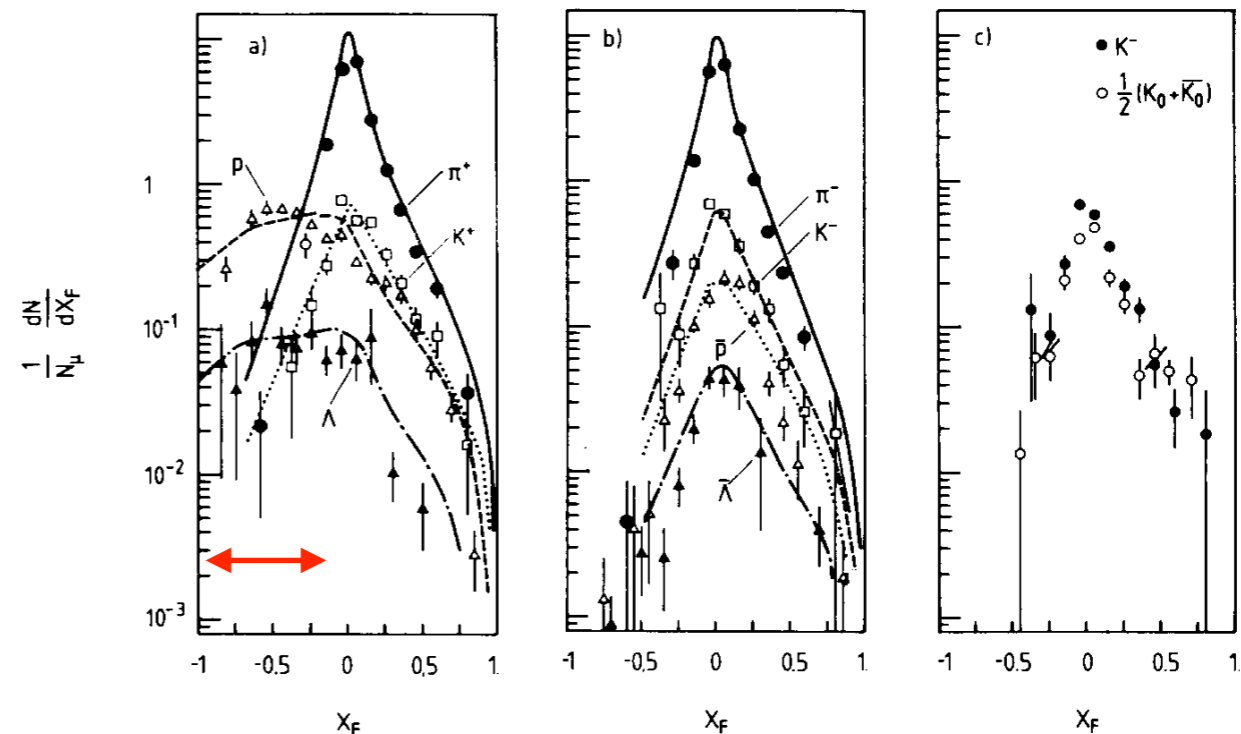

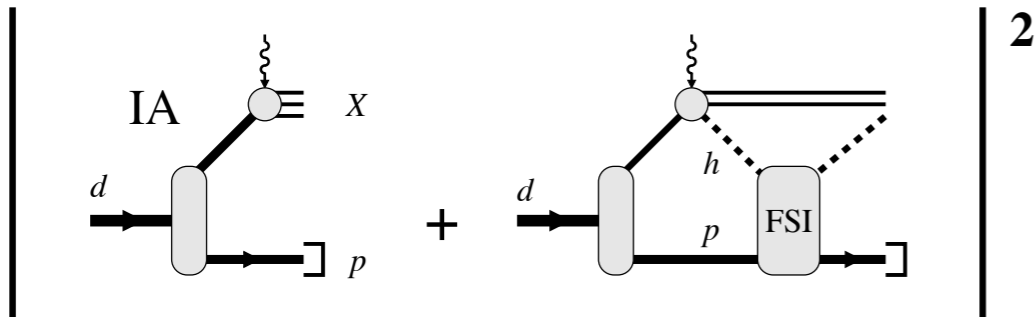

2

FSI calculation

Evaluated scattering of slow hadrons from spectator

QM description: IA + FSI amplitudes, interference

FSI amplitude has imaginary and real part:
Absorption and refraction

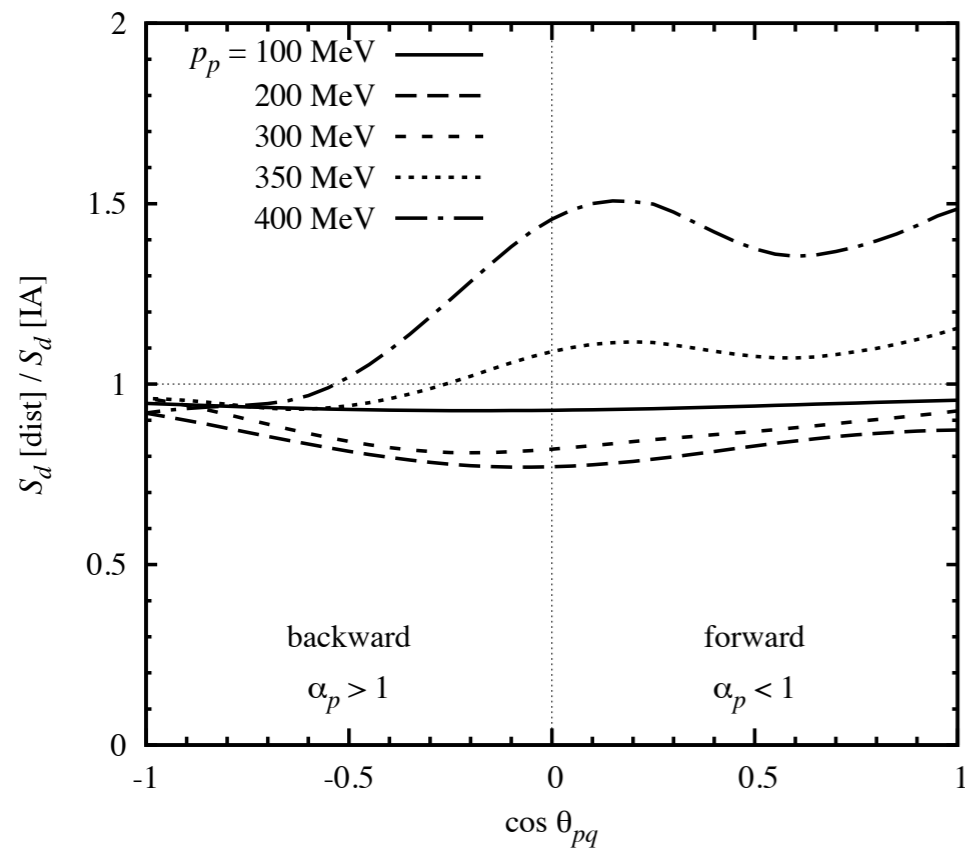

Momentum and angular dependence

$p_p \lesssim 300$ MeV: IA x FSI interference, absorptive, weak angular dependence

$p_p \gtrsim 300$ MeV: $|FSI|^2$, refractive, strong angular dependence

FSI angular dependence in deuteron rest frame

Results used in EIC simulations, analysis of JLab12 BAND experiment