

ePIC Management Plan for the Next 2-year Term

Conveners Meeting Presentation

John Lajoie and Silvia Dalla Torre

2/16/2023

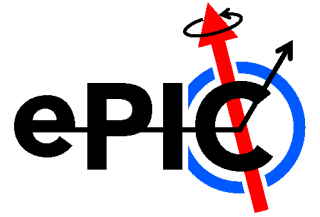

Collaboration Structure Including the Scientific Structure for the Next Two-year Term

Black dashed lines indicate communication paths (bidirectional)

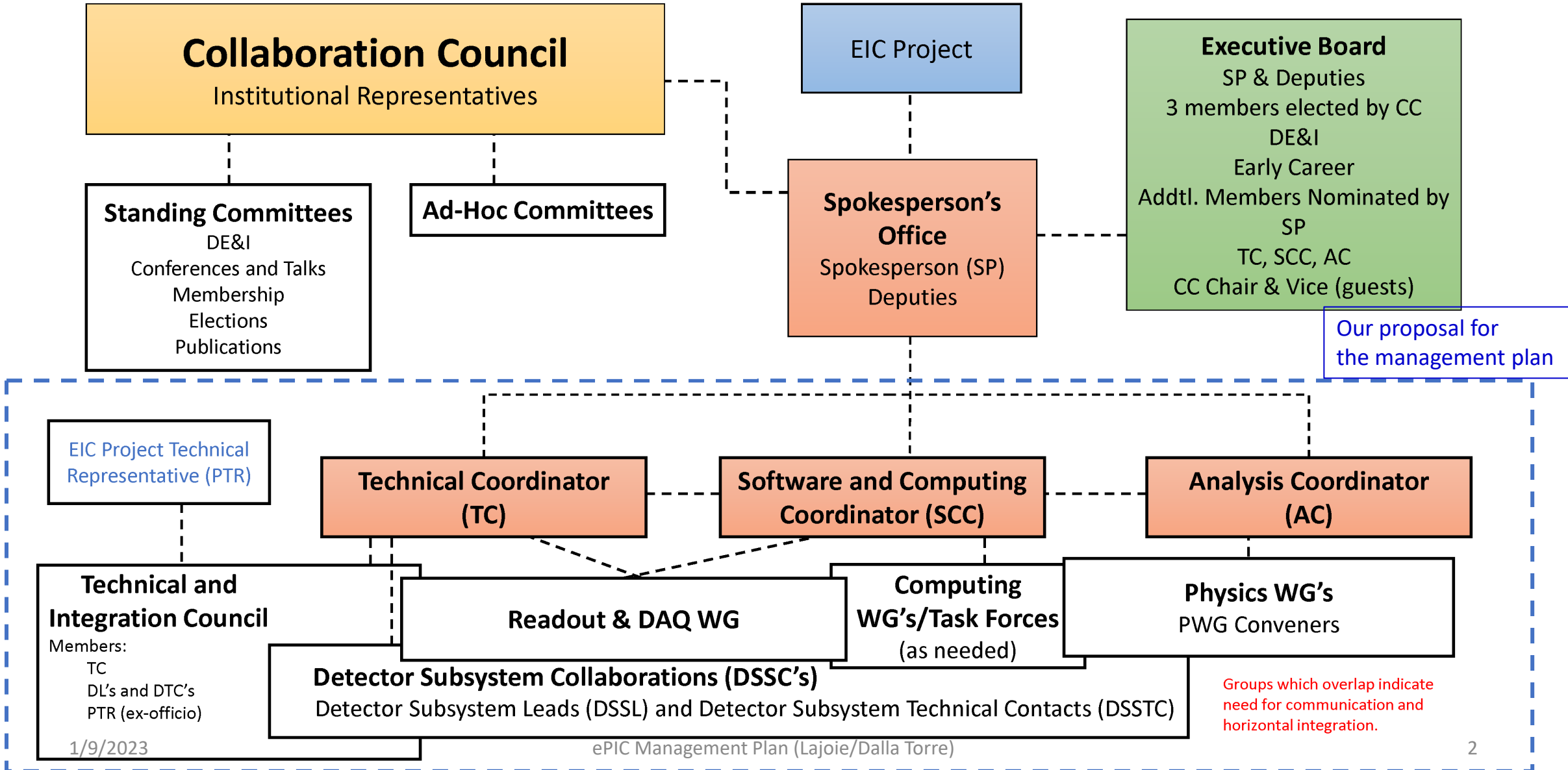

Collaboration Structure Including the Scientific Structure for the Next Two-year Term

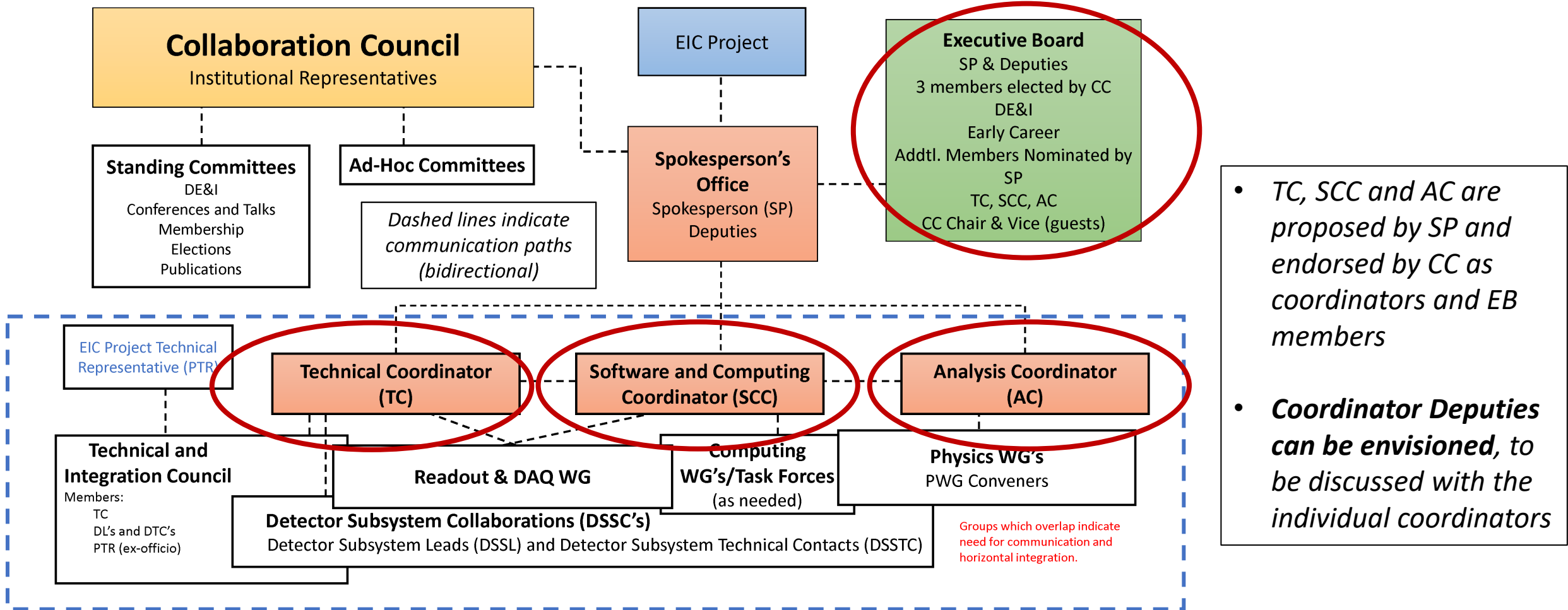

- *TC, SCC and AC are proposed by SP and endorsed by CC as coordinators and EB members*
- *Coordinator Deputies can be envisioned, to be discussed with the individual coordinators*

Collaboration Structure Including the Scientific Structure for the Next Two-year Term

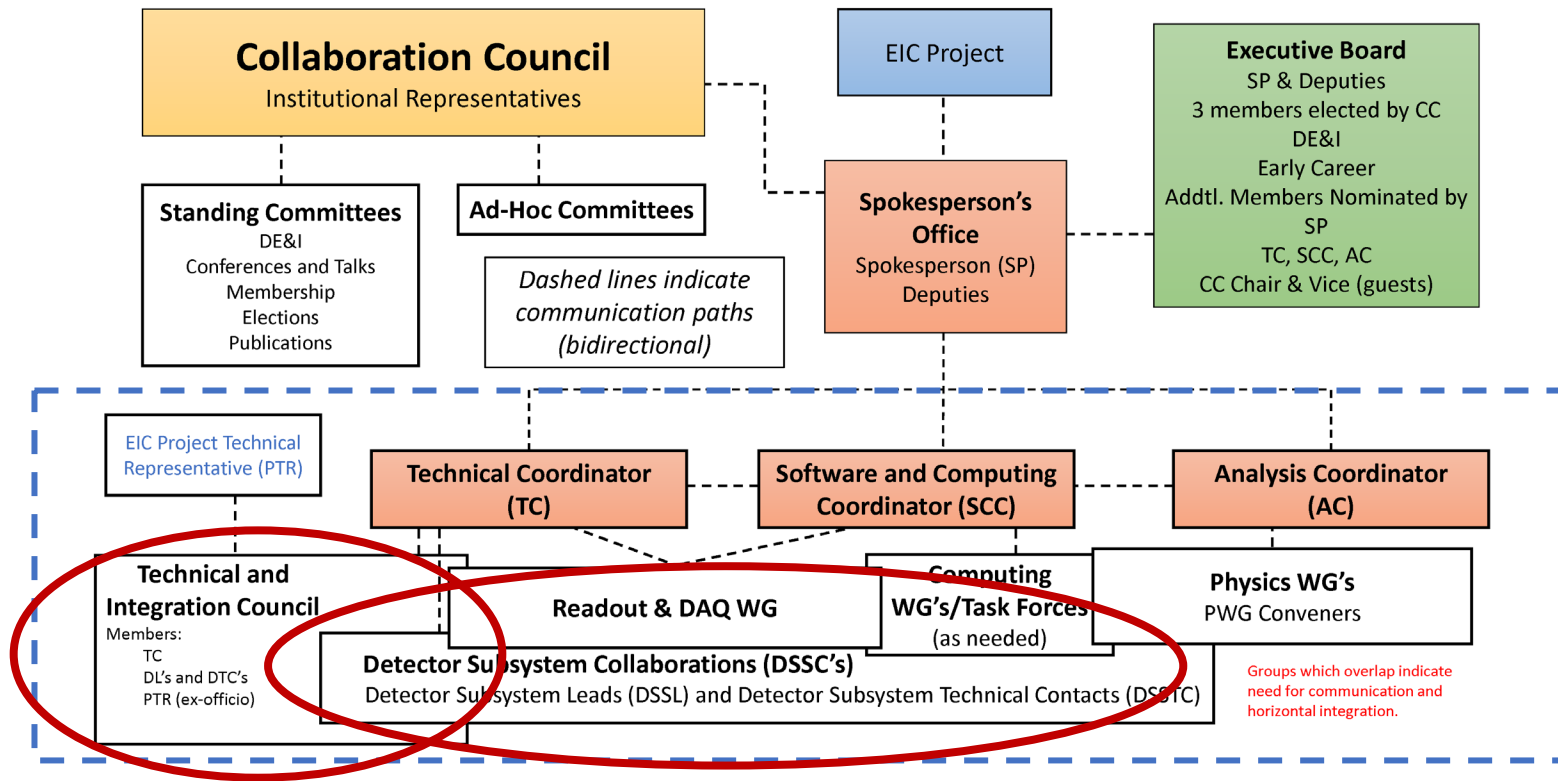

Technical and Integration Council is formed by

- TC
- DSSL's and DSSTC's
- R-O & DAQ conveners
- EIC PTR (ex-officio)

- **RO and DAQ**, which is transversal to sub-detectors, remains a separate WG with ~2 conveners

- *Need to evolve DWGs to a structure more appropriate to the (pre-)TDR/construction phase:*
WGs → Detector Subsystems
- *Each project corresponds to a subdetector built by a **Detector Subsystem Collaboration (DSSC)** of the groups and institutions contributing to it*
- *Each project collaboration will choose its **Detector Subsystem Lead (DSSL)** and **Detector Subsystem Technical Contact (DSSTC)***
- *Work in concert with EIC project CAMS*

Collaboration Structure Including the Scientific Structure for the Next Two-year Term

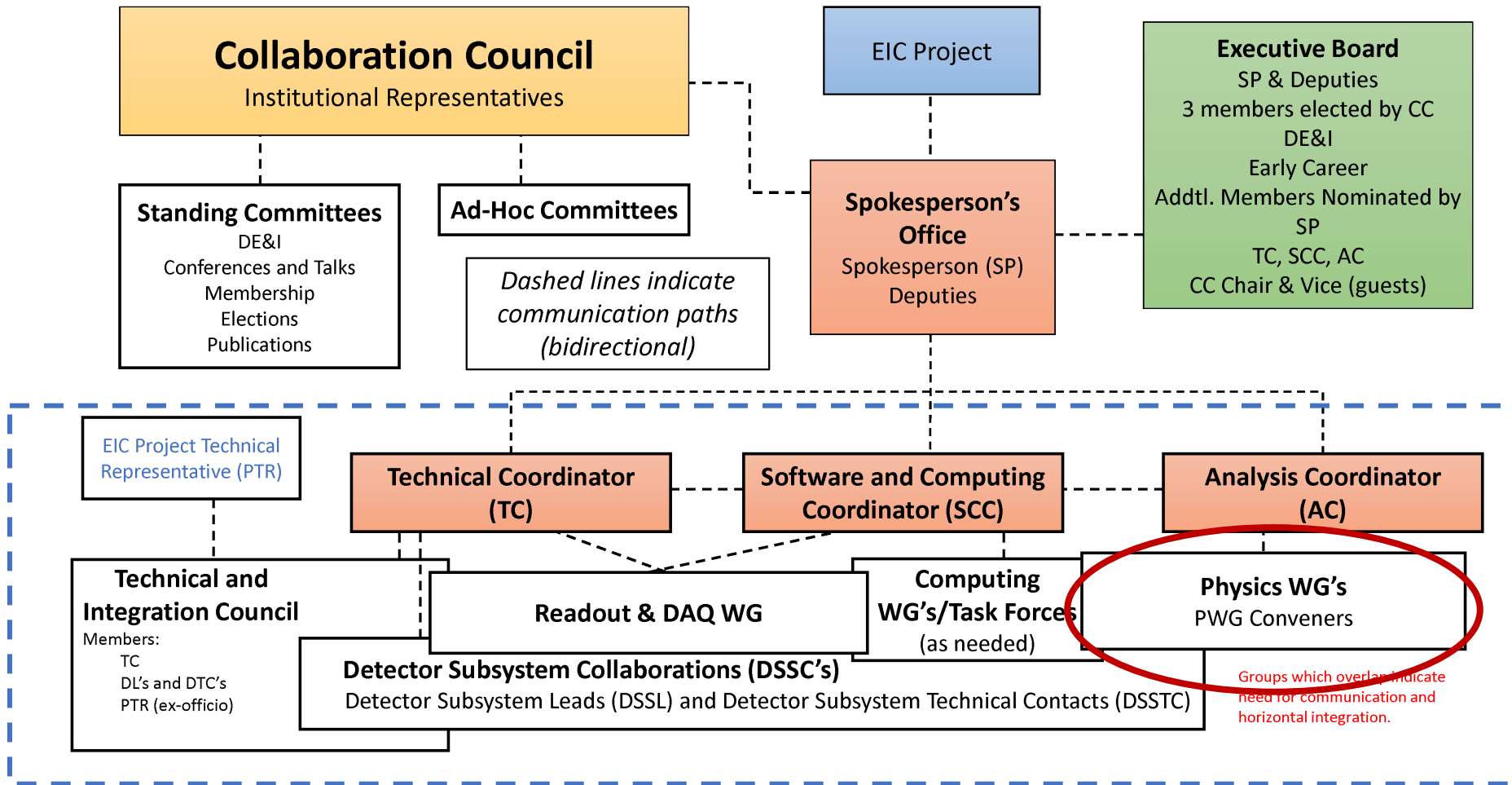

- *Physics WGs with ~ 2 conveners*
- *Number and domain of WGs to be discussed with the present WGs/collaboration*
- *Enhance flexibility with short-term task forces*

Follow-Up Meetings/Timeline

- Comp/SW and DWG/PWG Conveners
 - Wednesday, Feb. 15th and Friday, Feb. 17th
- Collaboration Discussion on Detector Subsystem Collaborations:
 - Friday February 24th, 10:30AM EST
- Collaboration Discussion on Physics Working Group Organization:
 - Friday March 3rd, 10:30AM EST
- Planning for CC Meeting Week of March 6th
 - TBD in conjunction with CC Chair/Vice-Chair
 - Approval of Management Plan and Coordinators, followed by implementation

Thank You

We want to thank all of the conveners and WG members for all their hard work over the past *two years* to chart a path to realizing the EIC science program. You have all been **incredible**, and all your hard work is appreciated.

The coming weeks will include a lot of change. Some people in convenor positions may continue, some may not – that should **not** be construed as a lack of confidence in any of the current conveners!

Discussion: Physics Working Group Organization

Collaboration Structure Including the Scientific Structure for the Next Two-year Term

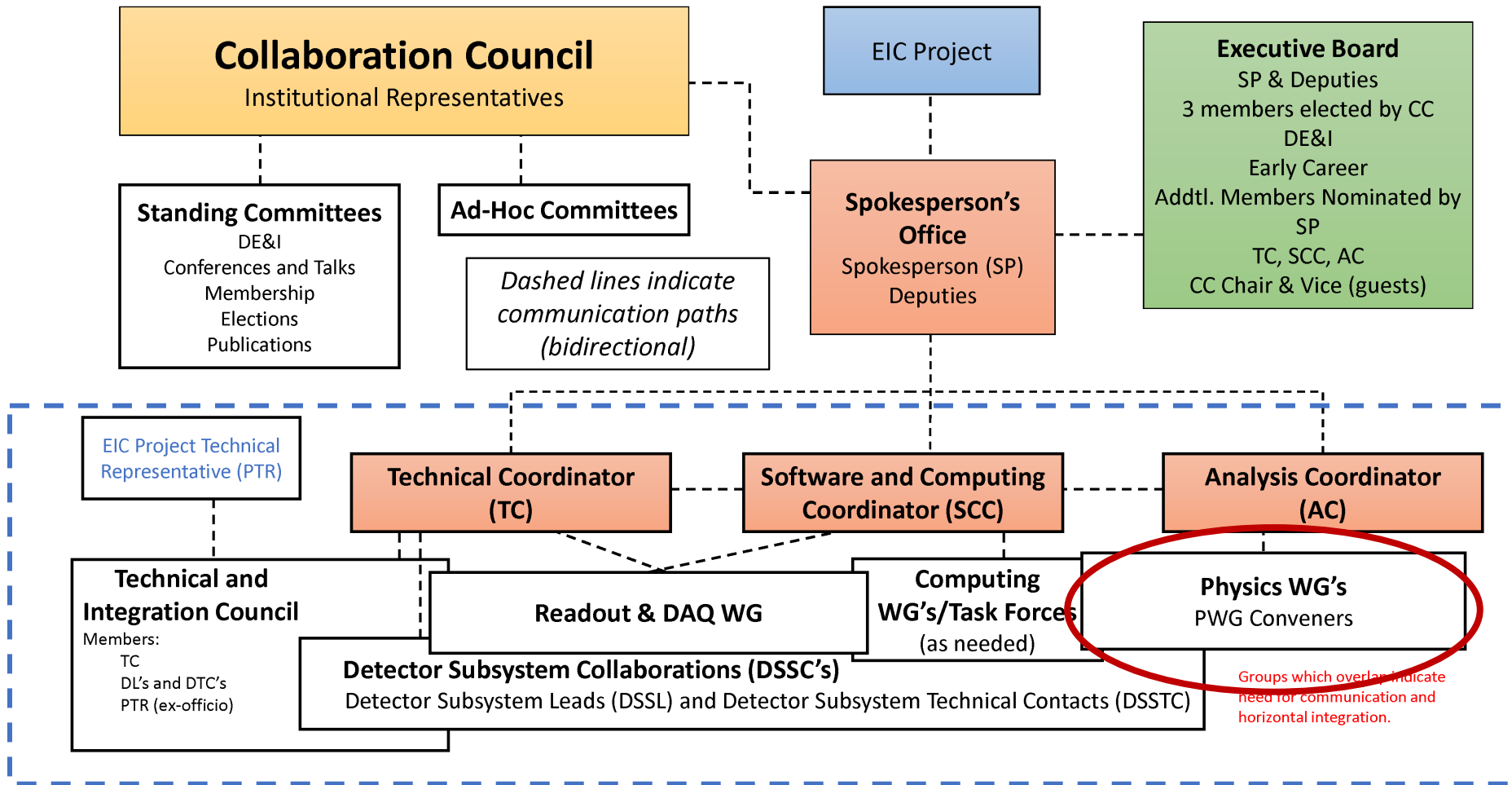

- **Primary Goal:** To use physics performance as a tool to guide the technical design
- WG structure provides a clear entry point for new collaborators
- Physics WGs with ~ 2 conveners
- Number and domain of WGs to be discussed with the present WGs/collaboration
- Enhance flexibility and communication with short-term task forces

Collaboration Structure Including the Scientific Structure for the Next Two-year Term

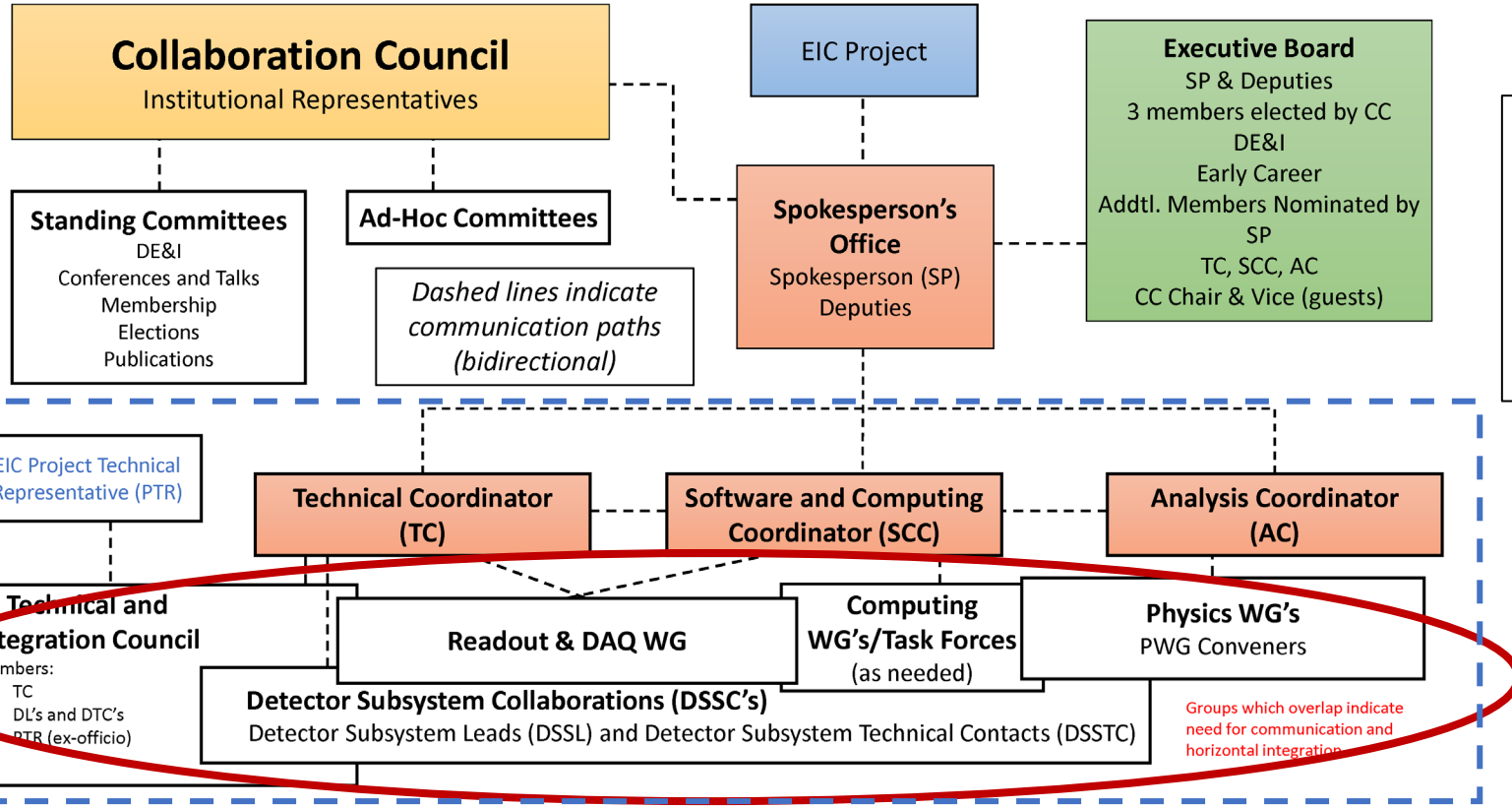

Transversal Task Forces

- *Proposed by coordinators (TC, SCC, AC)*
- *Formed as needed to address critical issues, or issues that require coordination between efforts*

Examples:

- *Background Task Force (formed by Project)*
- *Potential TF's: ACTS/Tracking TF, Global Event Kinematics, etc.*

ePIC Official meetings

Goal: each meeting has a clear purpose, reduce redundancy in meetings

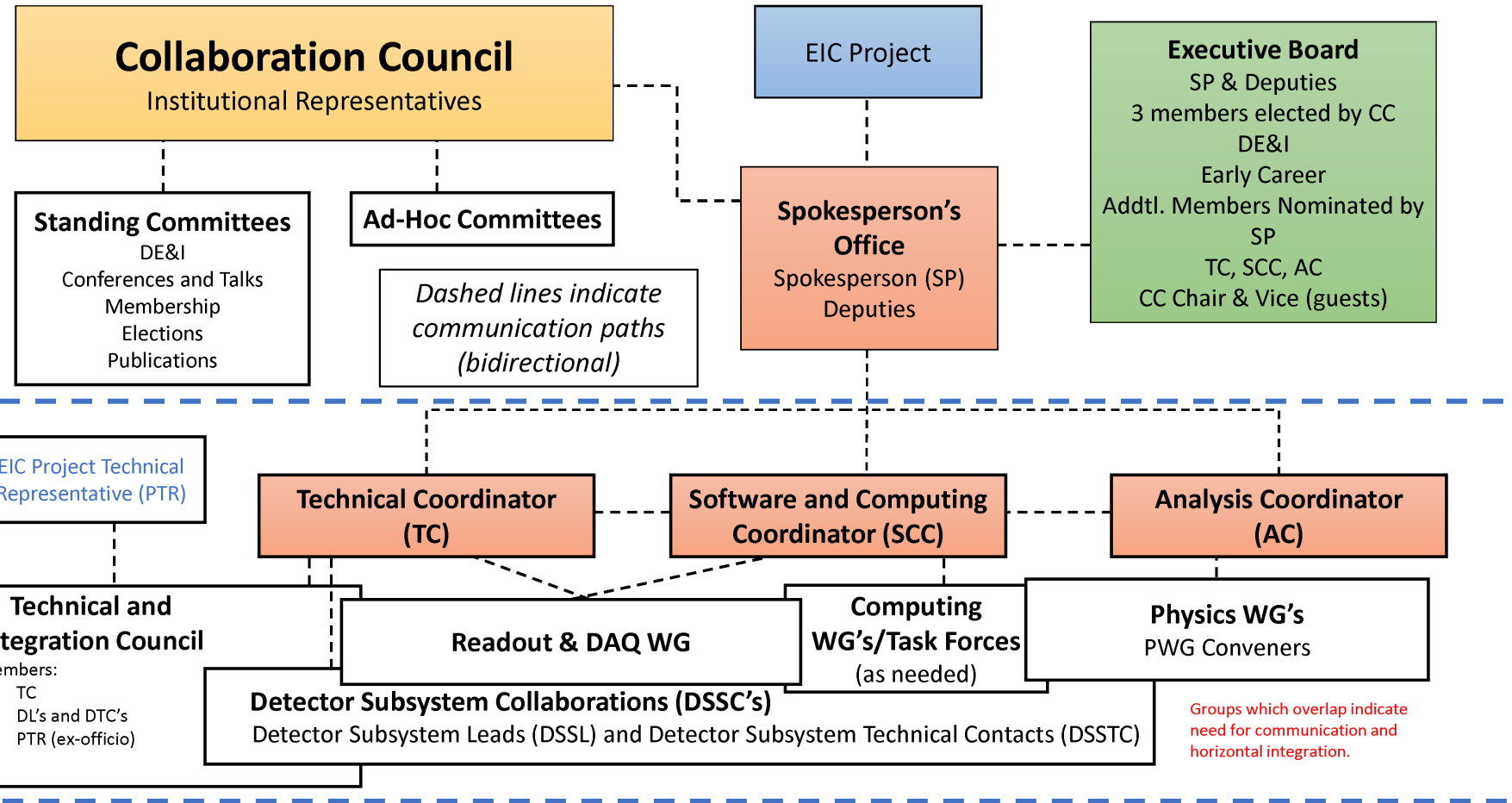

TIC, Software and Computing, Analysis Meetings:

1. Bi-weekly

Attendance:

- TIC, Computing WG/Task Force Leaders, PWG Conveners (respectively)
- Open to collaboration (publicly announced in the collaboration calendar)

ePIC Official meetings

Goal: each meeting has a clear purpose, reduce redundancy in meetings

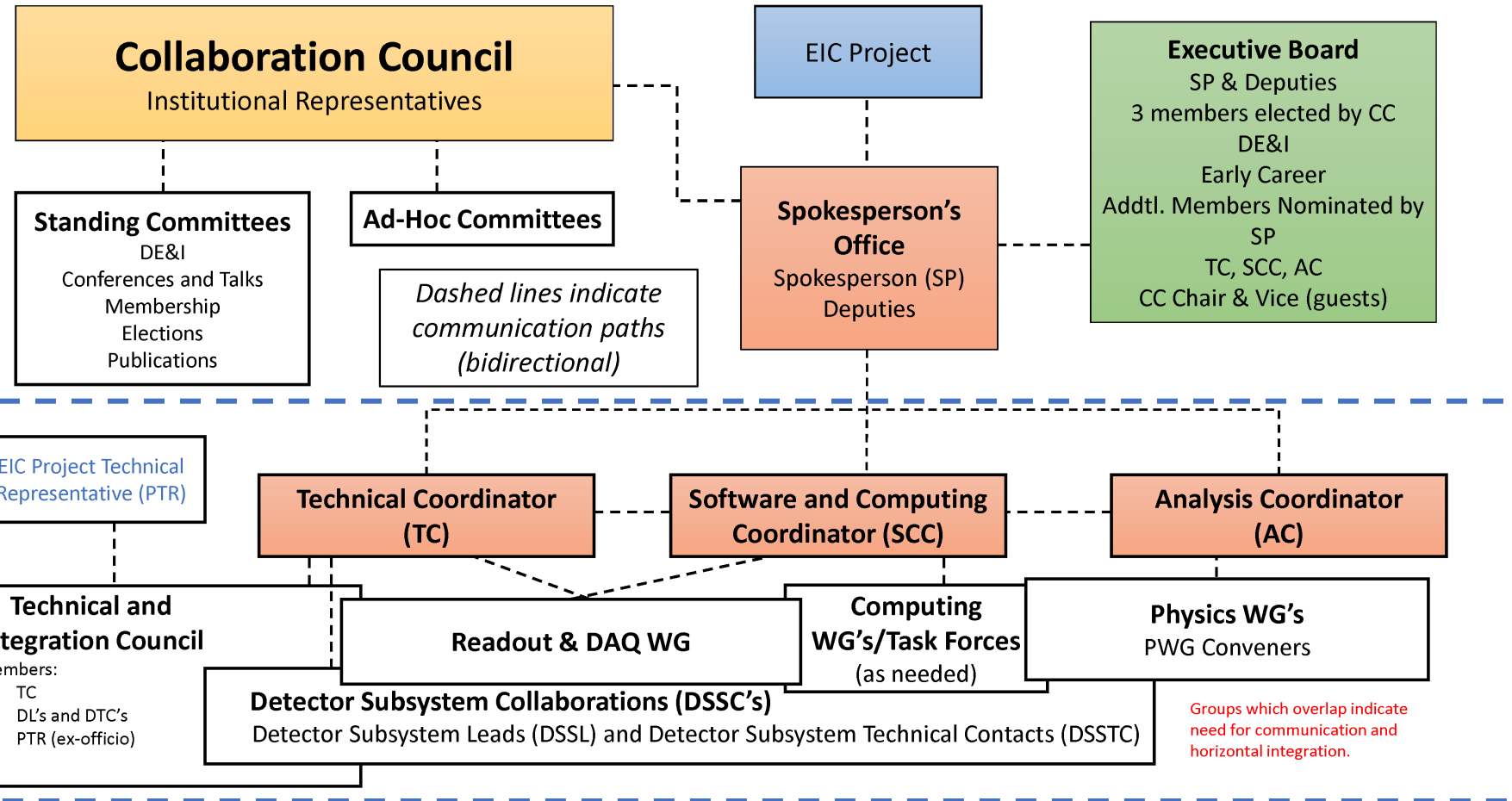

WG/TF/DSSC MEETINGS:

- *Detector Subsystems, RO and DAQ WG, computing WGs/Task Forces, PWGs will organize their agendas as they see fit*
- *Open to collaboration (publicly announced in the collaboration calendar)*

Questions for Discussion

- Is the current structure of PWG's appropriate to the task?
 - Inclusive
 - Semi-Inclusive
 - Exclusive, Diffraction and Tagging
 - Jets and Heavy Flavor
 - BSM & Precision EW
- How do we focus the PWG's and engage the collaboration? What TF's would be beneficial in this regard?
- How do we use the PWG's to help foster new members?
- What are the required skills for the Analysis Coordinator(s)?



Introductory Notes (1/2)

- This ePIC management plan is proposed with a focus on the next two years
- It has been developed by the SP/Deputy SP candidates jointly
- It includes contributions from the ePIC SC based on the experience gained together
- We consider this a Work-In-Progress and look forward to feedback and suggestions!

Introductory Notes (2/2)

- The Charter establishes the high-level managerial structure, while the scientific management structure is not depicted in the document
- Our focus: present our model for the ePIC scientific management structure
 - We expect this structure will evolve as the Collaboration evolves, according to the needs in the different phases
 - Emphasis here is on the structure needed to support CD-2/3

Collaboration structure from the Charter

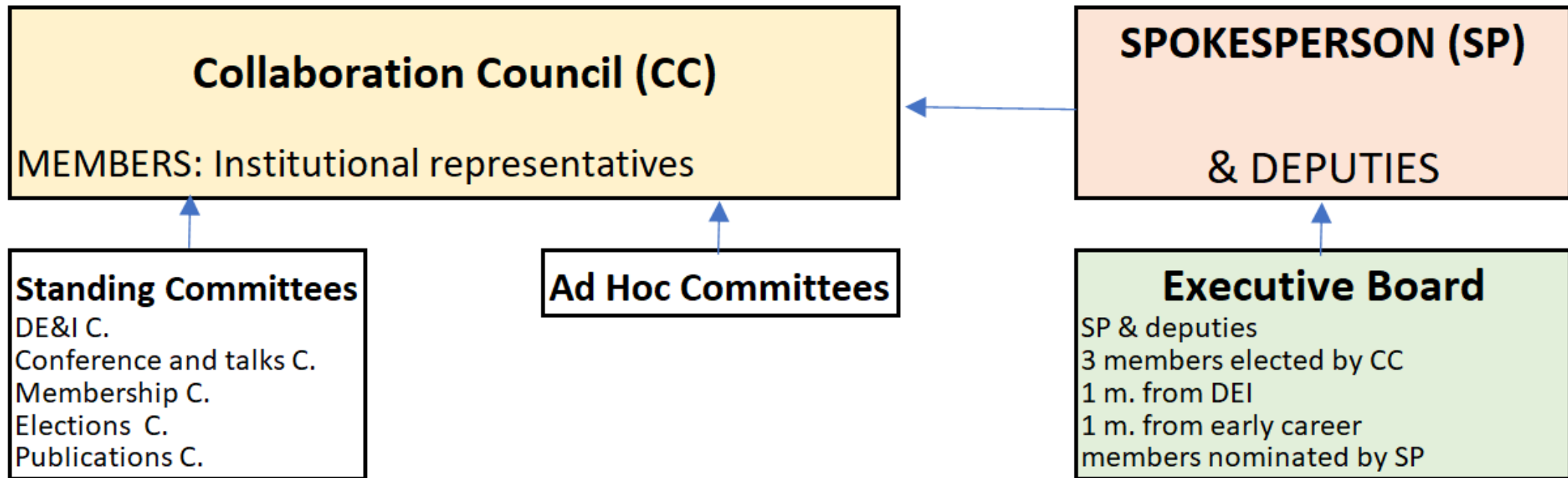

The high-level management structure, as set by the charter.

Collaboration Structure Including the Scientific Structure for the Next Two-year Term

Arrows indicate reporting pathways

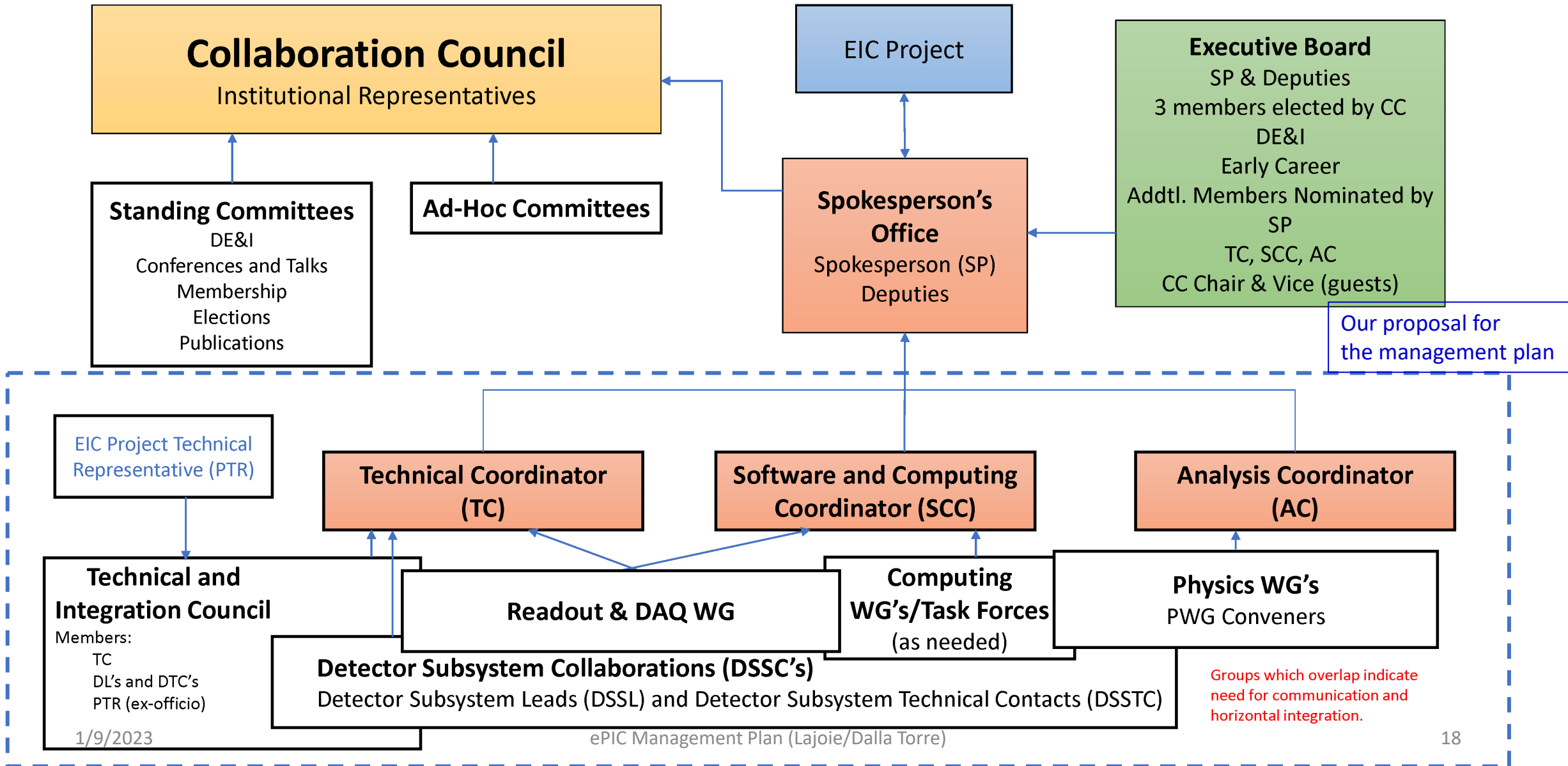

Collaboration Structure Including the Scientific Structure for the Next Two-year Term

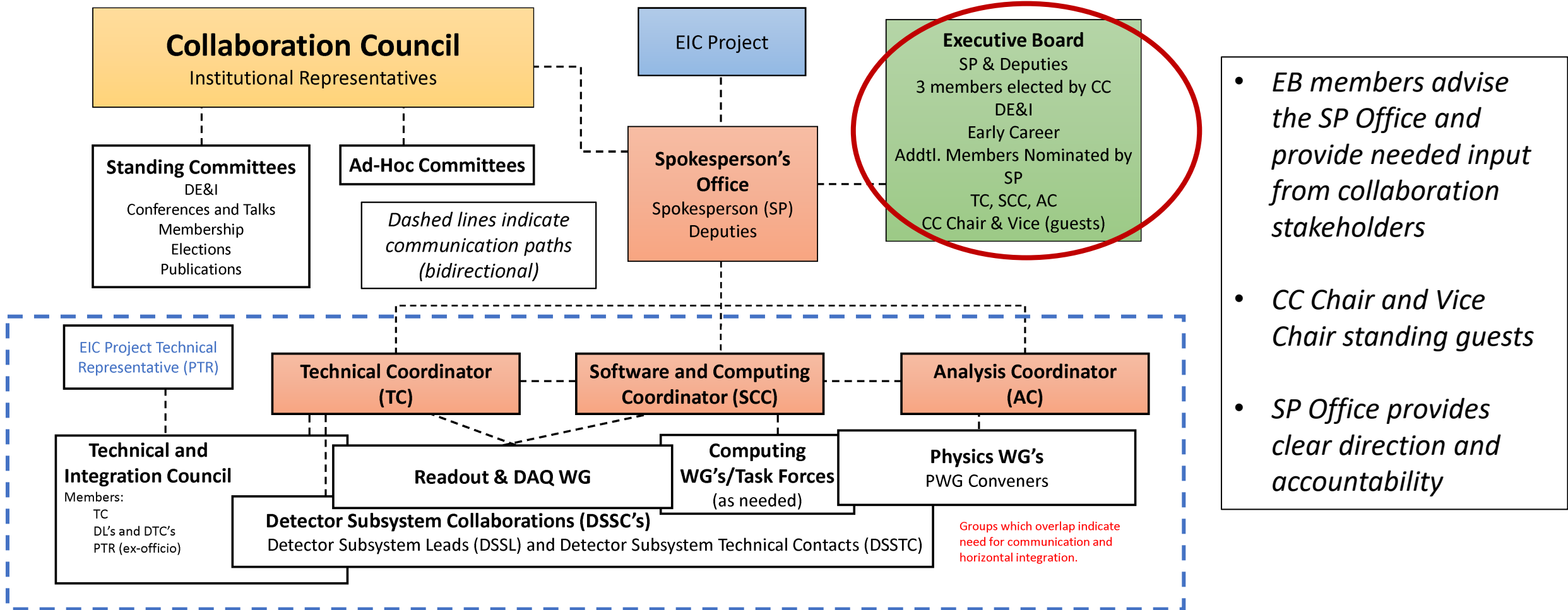

- *EB members advise the SP Office and provide needed input from collaboration stakeholders*
- *CC Chair and Vice Chair standing guests*
- *SP Office provides clear direction and accountability*

Collaboration Structure Including the Scientific Structure for the Next Two-year Term

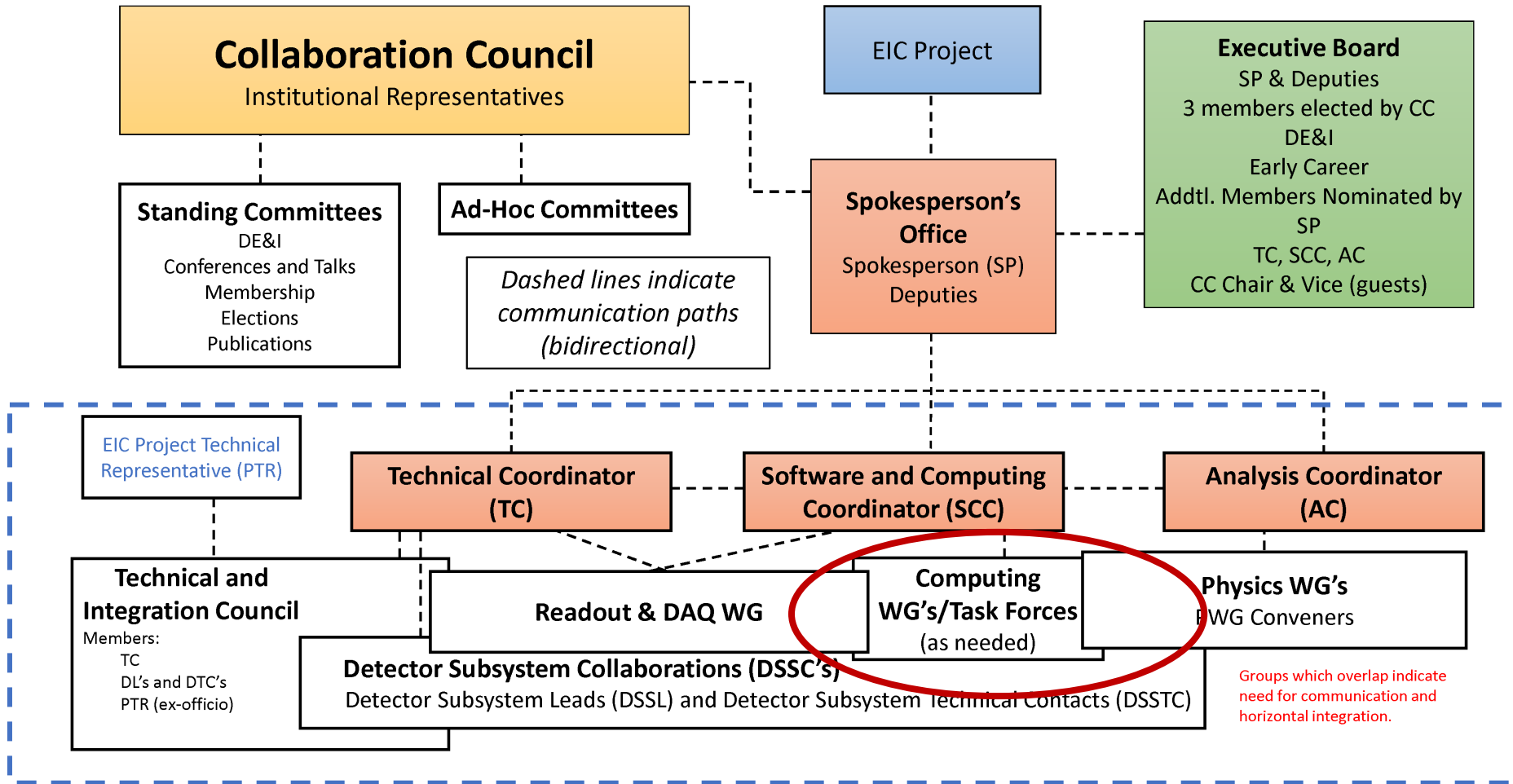

- *Software and Computing Coordinator*
 - *Interface with labs*
 - *Coordinates collaboration activity*
- *Computing WG/Task Forces:*
 - *Software architecture*
 - *Simulations*
 - *Computing resources*
 - *Advanced algorithms & AI*
 - *Documentation and User Support*
 - ...
- *A dedicated WG and flexible structure of subgroups*

Collaboration Structure Including the Scientific Structure for the Next Two-year Term

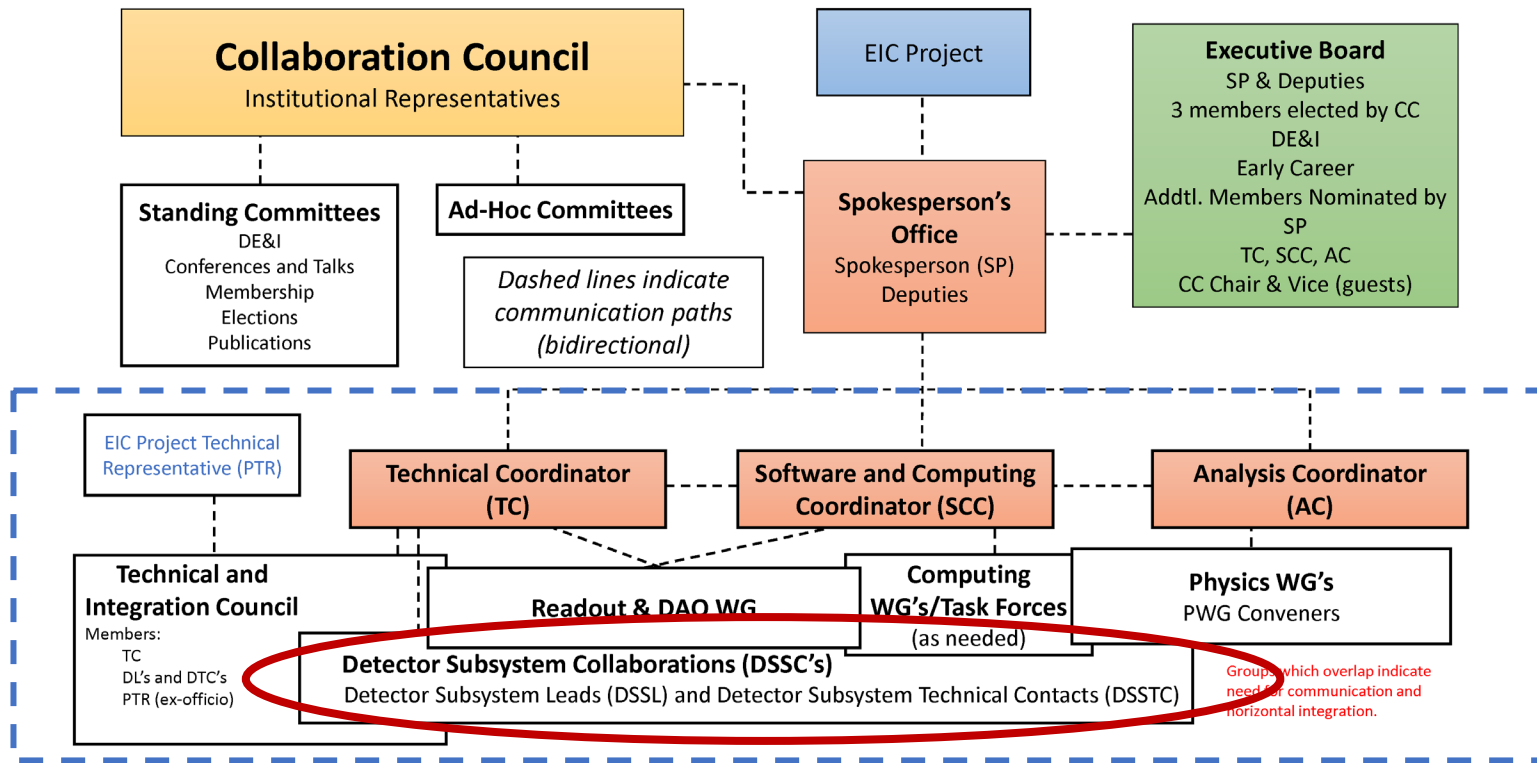

- *Need to evolve DWGs to a structure more appropriate to the (pre-)TDR/construction phase:*
WGs → Detector Subsystems
- *Each project corresponds to a subdetector built by a **Detector Subsystem Collaboration (DSSC)** of the groups and institutions contributing to it*
- *Each project collaboration will choose its **Detector Subsystem Lead (DSSL)** and **Detector Subsystem Technical Contact (DSSTC)***
- *Work in concert with EIC project CAMS*

Collaboration Structure Including the Scientific Structure for the Next Two-year Term

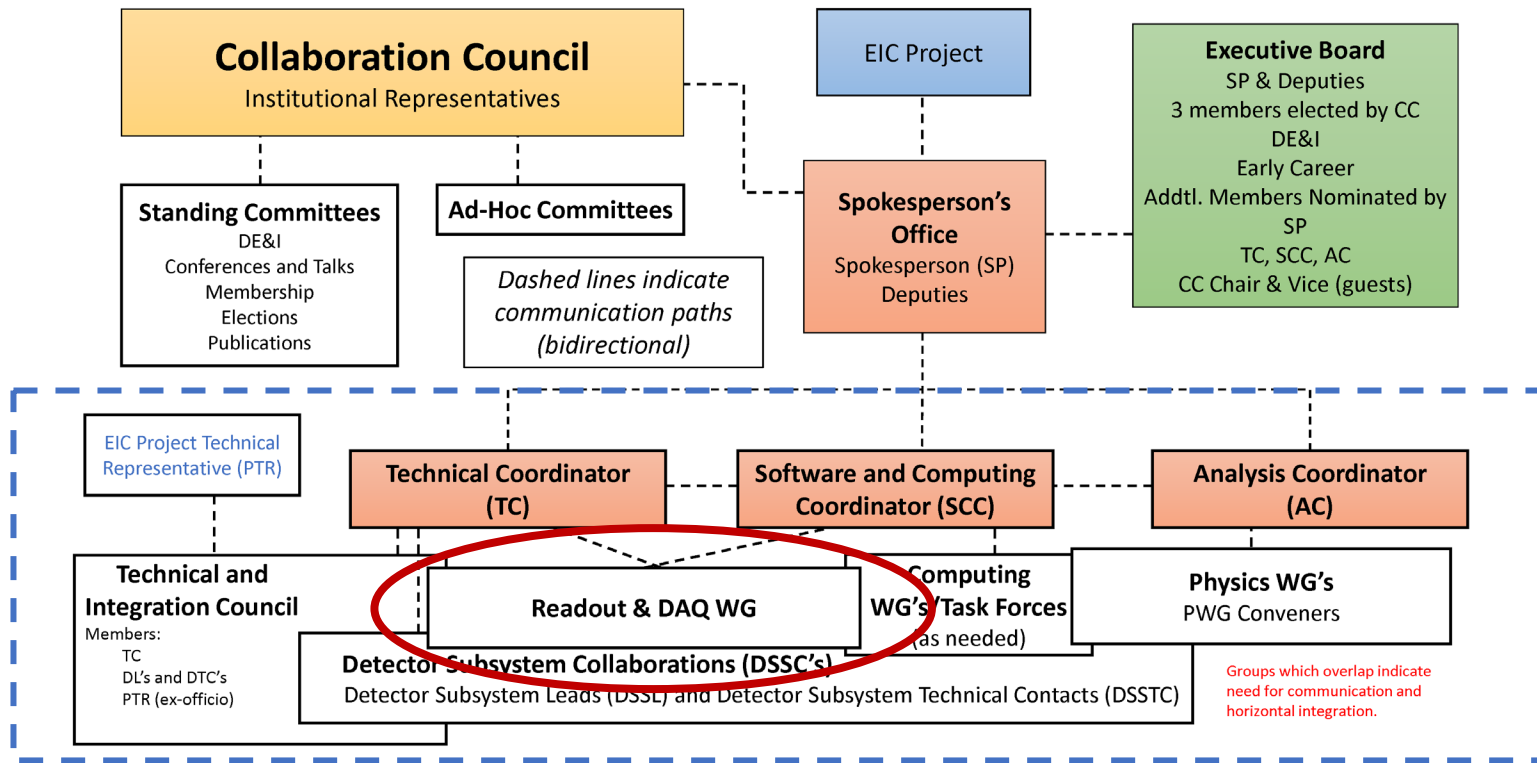

- **RO and DAQ**, which is transversal to sub-detectors, remains a separate WG with ~2 conveners

- *Need to evolve DWGs to a structure more appropriate to the (pre-)TDR/construction phase:*
WGs → Detector Subsystems
- *Each project corresponds to a subdetector built by a **Detector Subsystem Collaboration (DSSC)** of the groups and institutions contributing to it*
- *Each project collaboration will choose its **Detector Subsystem Lead (DSSL)** and **Detector Subsystem Technical Contact (DSSTC)***
- *Work in concert with EIC project CAMS*

Collaboration Structure Including the Scientific Structure for the Next Two-year Term

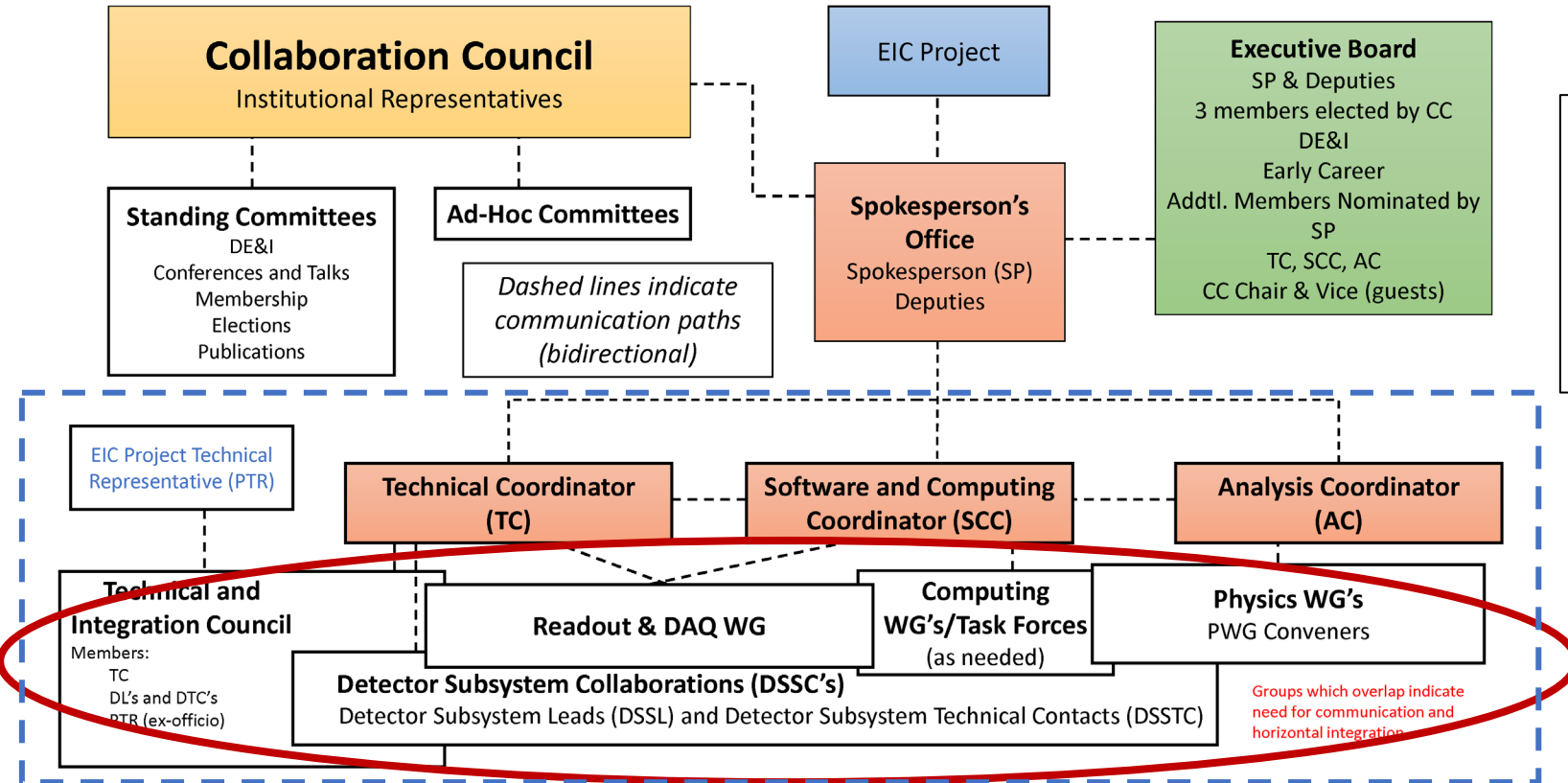

Transversal Task Forces

- *Proposed by coordinators (TC, SCC, PC)*
- *Formed as needed to address critical issues, or issues that require coordination between efforts*

Examples:

- *Background Task Force (formed by Project)*
- *Potential TF's: ACTS/Tracking TF, Global Event Kinematics, etc.*

Detector decision flow

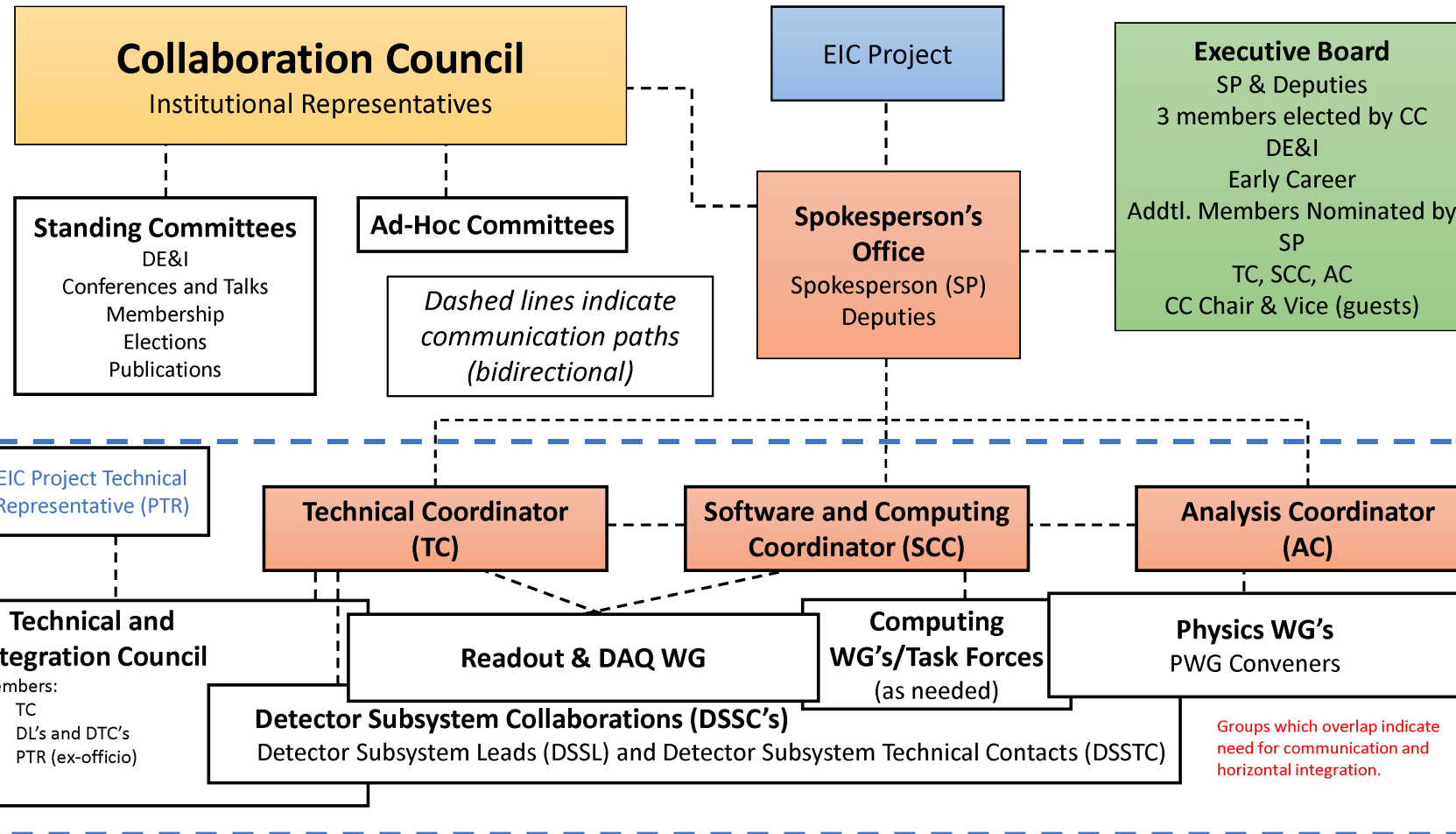

1. Review, analysis and report by TIC
2. Recommendation formulated in consultation with EB
3. SP submits the recommendation to CC

ePIC Official meetings

Goal: each meeting has a clear purpose, reduce redundancy in meetings

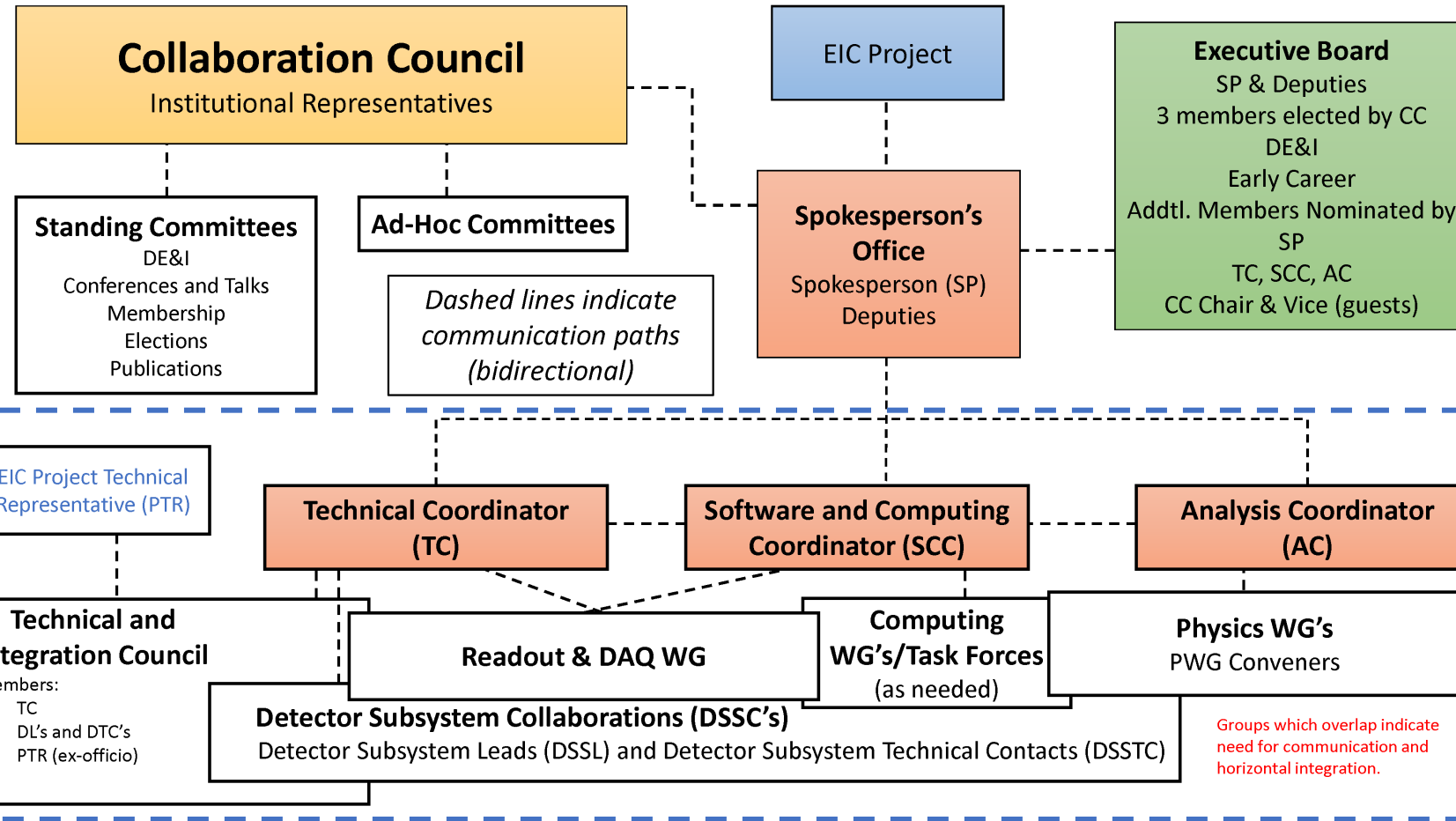

ePIC General Meetings:

1. Monthly (held at two times?)
2. Twice per year in-person (hybrid)
 - One per year outside US

Attendance: the whole collaboration

ePIC Official meetings

Goal: each meeting has a clear purpose, reduce redundancy in meetings

EB Meetings:

1. Bi-weekly
2. Additional meetings as needed

Attendance: the EB members and invited guests

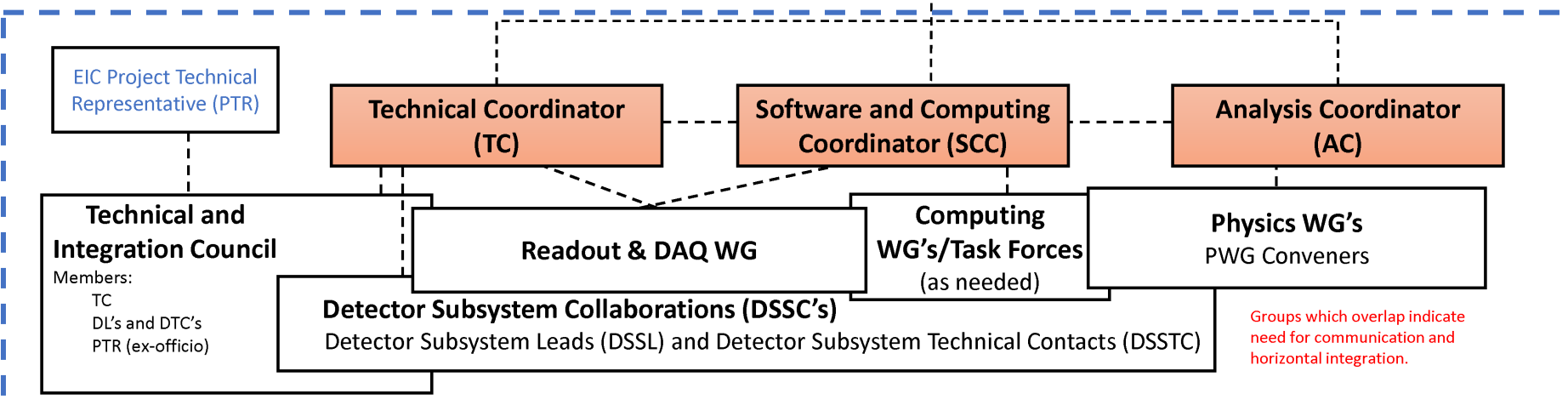
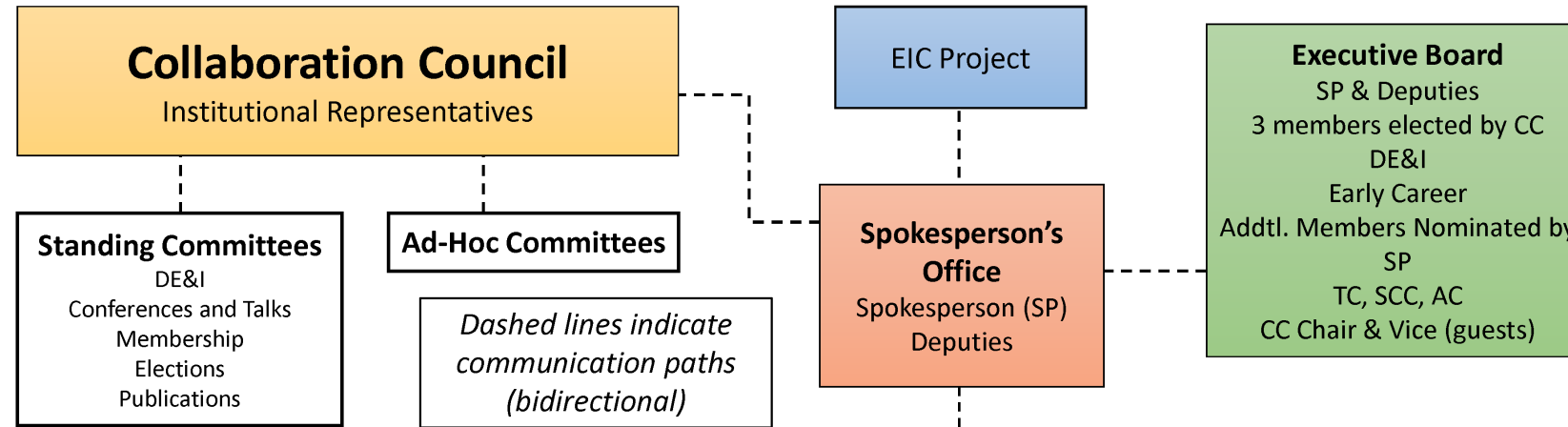

ePIC Official meetings

Goal: each meeting has a clear purpose, reduce redundancy in meetings

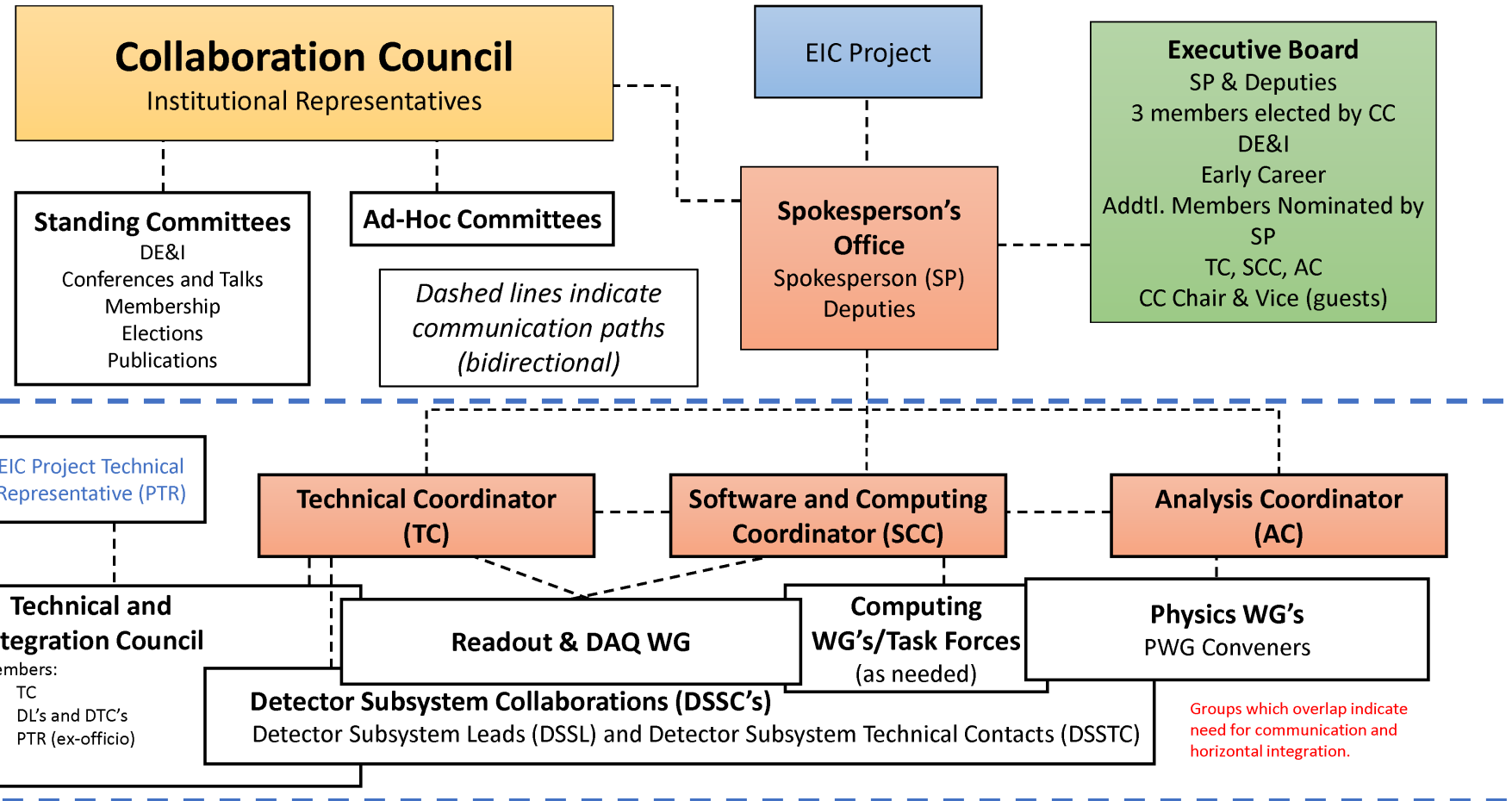

TIC, Software and Computing, Analysis Meetings:

1. Bi-weekly

Attendance:

- TIC, Computing WG/Task Force Leaders, PWG Conveners (respectively)
- Open to collaboration (publicly announced in the collaboration calendar)

ePIC Official meetings

Goal: each meeting has a clear purpose, reduce redundancy in meetings

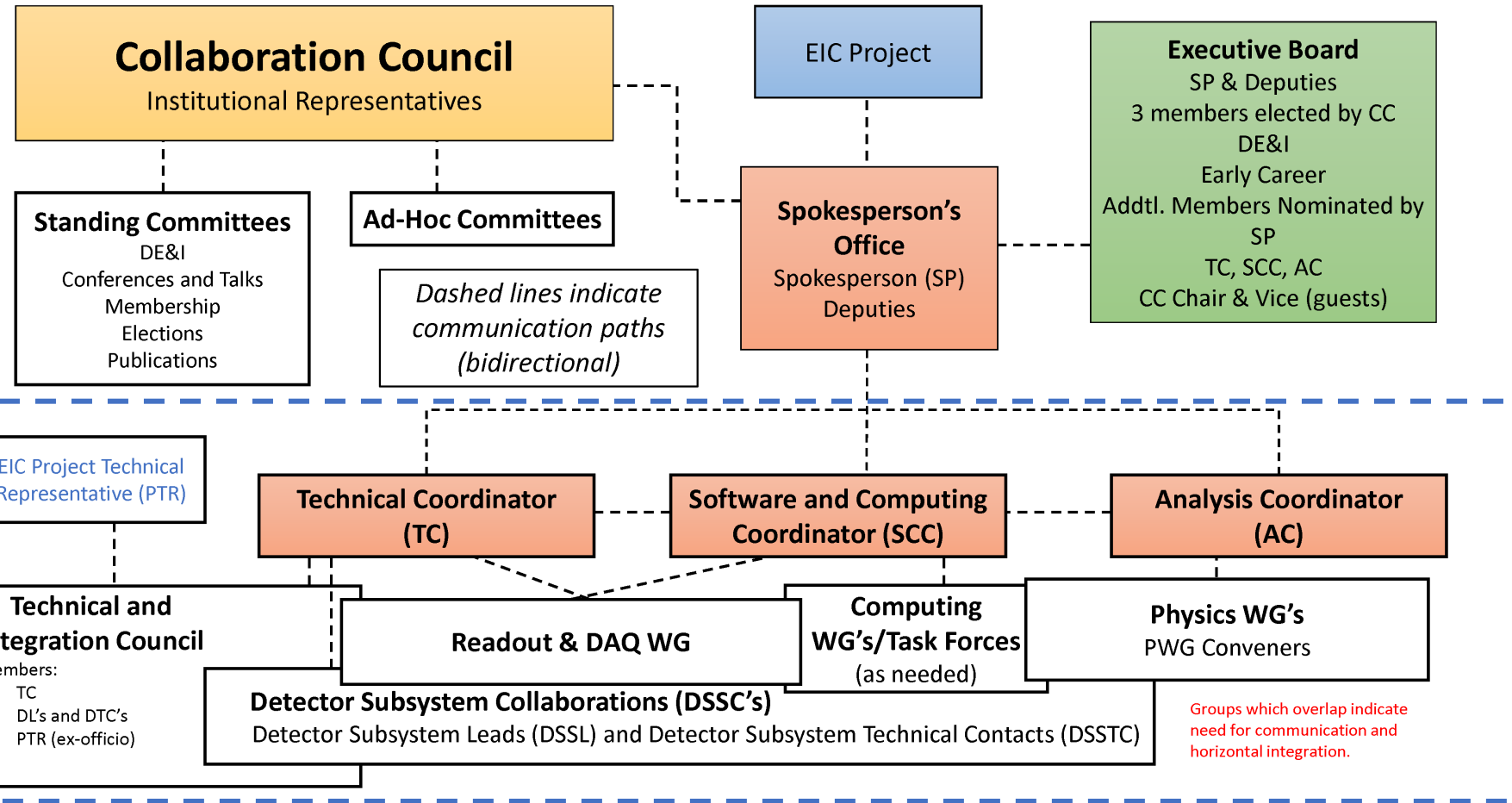

WG/TF/DSSC MEETINGS:

- *Detector Subsystems, RO and DAQ WG, computing WGs/Task Forces, PWGs will organize their agendas as they see fit*
- *Open to collaboration (publicly announced in the collaboration calendar)*

ePIC Official meetings

Goal: each meeting has a clear purpose, reduce redundancy in meetings

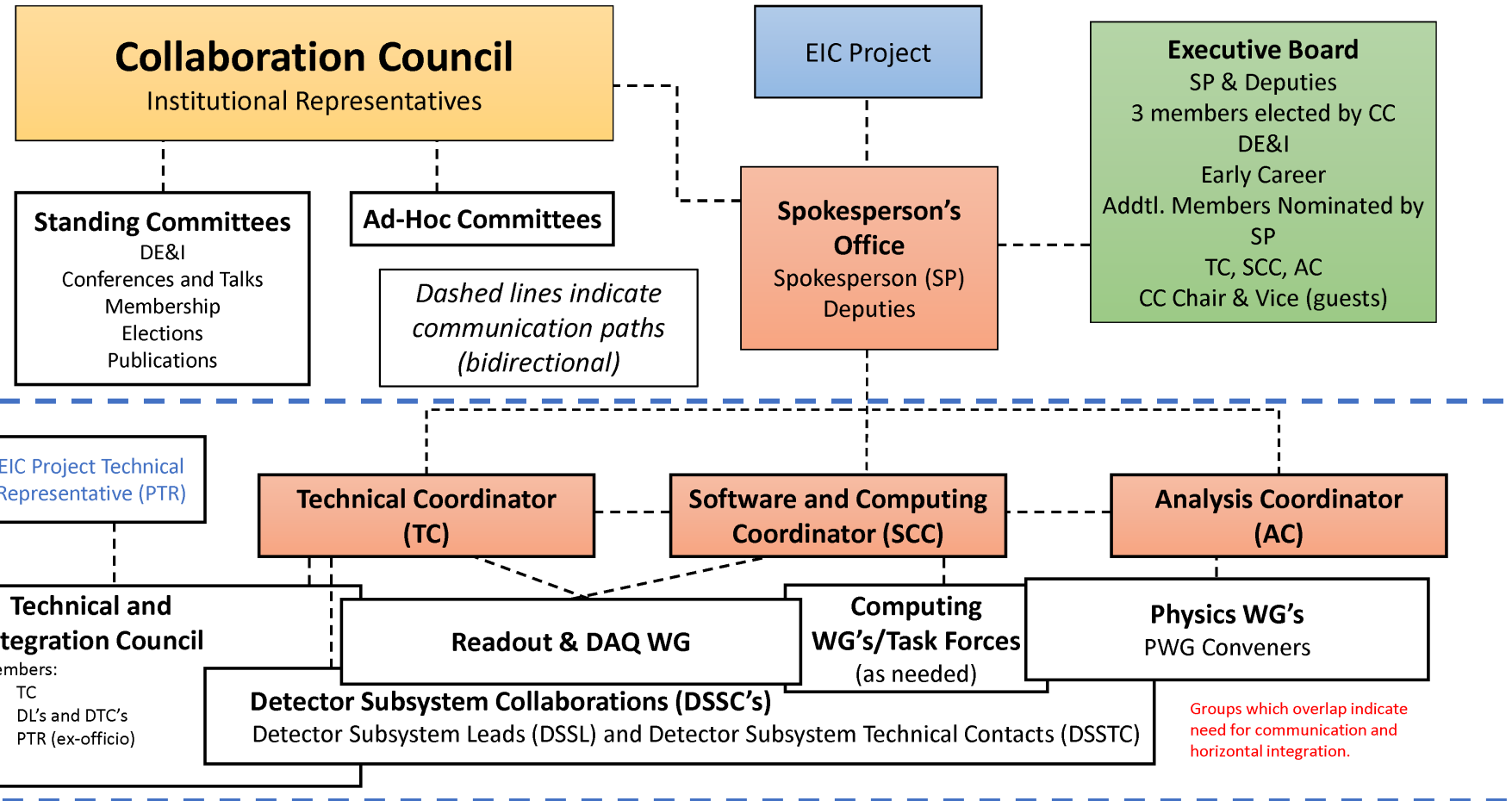

CC Meetings

(TBD by CC):

1. SP-office would suggest meetings every few (~3) months

- In-person meetings should include CC meeting

Attendance: the whole collaboration

The SP Office

- SP: **John Lajoie**
- Deputy SP: **Silvia Dalla Torre**

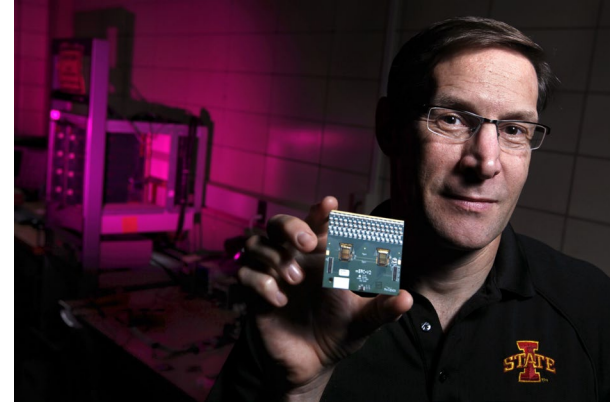

- Both SP and Deputy SP will dedicate to ePIC > 80% of their professional time
- Well defined distribution of responsibilities

The SP-Office and Responsibilities

SP:

- Represents the Collaboration in all circumstances
- Overall responsibility for ePIC scientific management
- Relationship and communication with EB, PM, CC and its Committees
- Relationship with BNL, JLab and laboratory user groups, university groups
- Raising the visibility of ePIC/EIC worldwide

Deputy SP:

- Communication with the coordinators (TC, PC, CoC) and the corresponding board (TIC)
- Managing the detector technology and integration decision process
- Relationship with RRB
- Relationships with Institutes/Groups concerning effective FTE and in-kind

Joint Responsibilities:

- We plan to work as a collegial team. The areas above are intended as guidelines to make the work efficient.

Increasing International Engagement

- ePIC will need strong international engagement in order to succeed!
- Role of the Spokesperson's Office:
 - Outreach/encourage participation in ePIC
 - Help nuclear physics communities raise EIC visibility in their home countries
 - Support international groups by helping them engage with ePIC, match their talents and capabilities to work that need to be done
 - Provide assistance/training to students and postdocs integrating into WG's
 - Help with laboratory appointments, access to resources
 - Assist Project with coordinating planning for international contributions
 - Especially workforce in international groups
 - Support the efforts of the Project in the RRB

Community

- To be successful we will not only need to grow the ePIC Collaboration but take full advantage of the skills, talents, and capabilities of all our collaborators
 - Silvia and I are dedicated to making ePIC a collegial, friendly, safe, and welcoming environment for everyone
 - It is critical to build this into ePIC culture from the very beginning!
- Support the CC in developing a strong Code of Conduct
 - The ePIC charter includes concrete provisions to address misconduct
 - Code of Conduct should be developed quickly as a policy document
- Support the CC in appointing a Talks Committee
 - Track assignment of talks, ensure an equitable distribution across all groups
- Support the professional development of junior scientists
 - Provide opportunities for leadership and recognition
- Facilitate participation in ePIC
 - While some can dedicate all their time to ePIC, many will have to balance ongoing commitments. Make sure that everyone can contribute to the best of their ability.

ePIC Relationship with PM (via SP supported by CC)

Major Guidelines:

- Work with EIC PM to ensure the realization of the full EIC science program in the ePIC detector
 - PTR an ex-officio member of the TIC
 - Detector Subsystem Collaborations work in concert with EIC CAMs
- Facilitate communication to ensure transparency in project decisions and the prompt exchange of information
- Ensure that ePIC responds in a timely and complete manner to EIC PM requests
- Provide the link between the collaboration and EIC PM to guarantee a constructive and friendly environment for ePIC
- Support collaboration proposals to PM
- Maintain a constructive and cooperative attitude

Transition of the Scientific Structure (1)

General considerations :

- The transition of the high-level Collaboration management structure will follow the path indicated in the charter
- The transition of the scientific structure is proposed in the next slides and follows the guiding principles:
 - Complete the transition in a reasonable time, but avoid disruption due to unnecessarily sharp transitions
 - Work as much as possible in consultation with the community
 - Truly dedicated WG conveners, DL's and DTC's

Transition of the Scientific Structure (2)

- PWGs:
 - Presently 5 WGs with 4 conveners each
 - Model to be discussed with the community: 5 or 6 PWGs with 2 conveners each
 - Look at ways to maintain contact between PWG's, make it possible for people to be active in multiple PWG's
- Computing:
 - Areas of Responsibility:
 - *Software architecture; Simulations; Computing resources; Advanced algorithms and AI; Documentation; User Support;*
 - Presently: 2 WGs with 4 conveners each (condensed to one group)
 - Possible model:
 - Flexible subgroups and task forces
 - To be determined in consultation with the community

Transition of the Scientific Structure (3)

- R-O & DAQ:
 - Connections to all detector projects
 - Presently 1 WG with 4 conveners
 - Model proposed: 1 WG with 2 conveners
- Subdetectors:
 - Presently: 6 WGs with 4 conveners each
 - Proposed model:
 - Detector Subsystem Collaborations (DSSC's) each building a well-defined subdetector
 - Each DSSC determines its Detector Subsystem Leader (DSSL) and Detector Subsystem Technical Contact (DSSTC)
 - The breakdown in projects to be discussed/optimized with the collaboration

The Ongoing GD/I Review Process (BECal/backwards RICH)

- Review process is already underway:
 - The review committee is GD/I with external reviewers
 - External reviewers contacted, dates set, charge discussed with proponents
- GD/I remains in charge of the process as a review committee
 - No change to current plans
 - GD/I will provide a report to the EB
 - GD/I will be terminated after the completions of these reviews
- The TIC will be set up in parallel to this process