

Longitudinally separated Forward HCal (LFHCal) Option Discussion - Update

March 13, 2023

Friederike Bock (ORNL)

F. Bock (ORNL), O. Hartbrich (ORNL), N. Novitzky (ORNL), N. Schmidt (ORNL)

Simulation updates



- Focussing on options 1b (LFHCal with burried SiPMs) & 2 (GFHCal)
- Progress on LFHCal:
 - ▶ Simulations assumed to perform the same between option 1/1b increased realismn of simulations (this talk)
 - ▶ Updated mechanical model to option 1b (Eliots talk)
 - ▶ New vendor quotes in the works for tungsten & steel
tungsten price equal for option 1 & 1b (~ 450 /absorber plate)
- Progress on GFHCal:
 - ▶ Improving realism of GFHCal (digitization, clustering, geometry)
 - ▶ Understanding where significantly reduced performance originates (this talk)

LFHCal simulations

source code here: [dd4hep](#), [EICrecon](#)

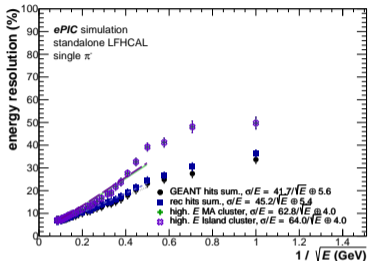
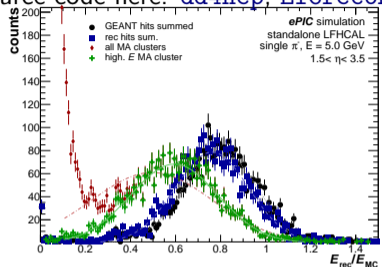
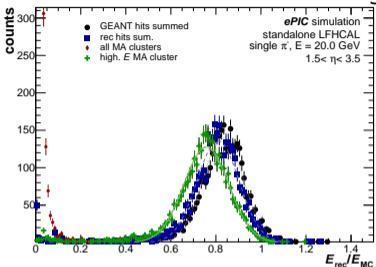

- Full implementation of hit chain (including basic noise simulation) & first version of clustering
- All simulations done with only HCal & single particle simulations
- Resolution calculated with time & energy cut offs
- Fitting restricted to > 4 GeV (as for CALICE data) resulting in more realistic $1/\sqrt{E}$ - term

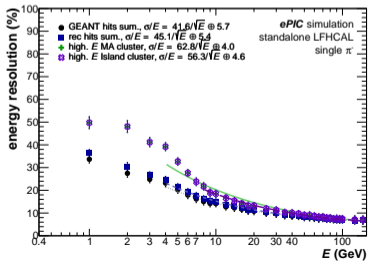

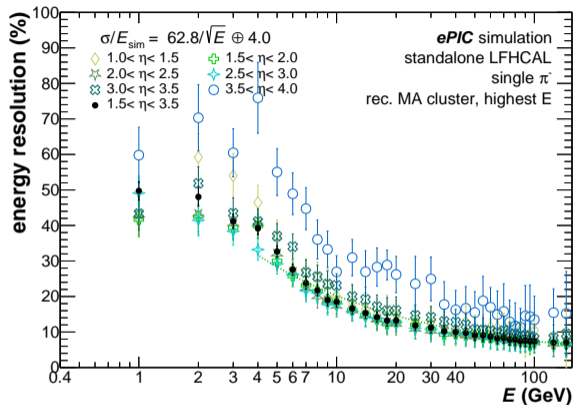
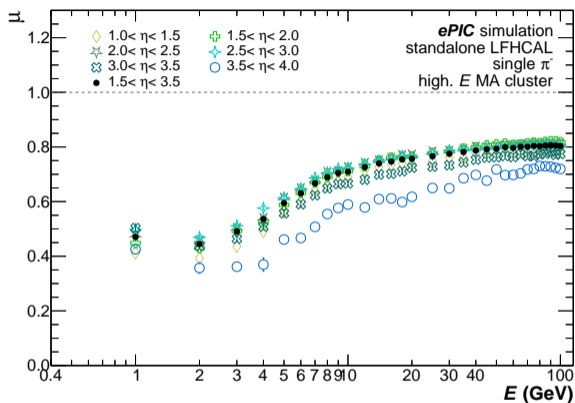

- Current implementation without insert
- Mild eta dependence $1.5 < \eta < 3.0$
- Small leakage seen for $1.0 < \eta < 1.5$ & $3.0 < \eta < 3.5$, significant losses beyond $\eta = 3.5$

LFHCAL simulations vs phi

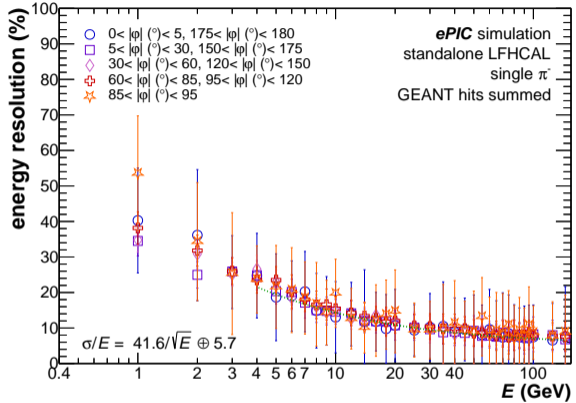
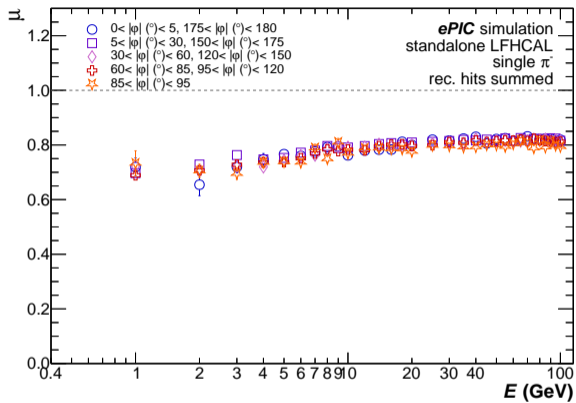

- Current implementation without insert
- No phi dependence

gFHCAL detector setup

source code here: [GFHCAL_geo.cpp](#)

Alternative forward HCal design with longitudinal instead of transverse absorbers and scintillators

- Longitudinal absorber plates 120cm steel and 10cm tungsten
→ 16.8mm thickness, average sampling fraction: $f = 0.027$
→ additional version with more layers: $f = 0.036$ (LFHCAL $f = 0.033$)
- Longitudinal $0.4 \times 5 \times 10 \text{cm}^3$ Scintillator tiles
- Removable Scintillator+pcb mini frames
→ 1mm PCB space in current simulation
- Detector made of $20 \times 10 \text{cm}$ and $30 \times 10 \text{cm}$ front face modules
→ violet and cyan colors in right figure, respectively

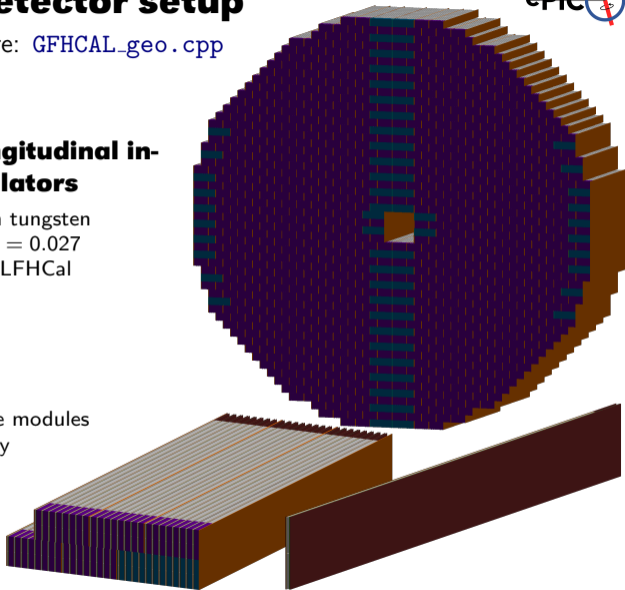

GFHCal simulations

source code here: [dd4hep](#), [EICrecon](#)

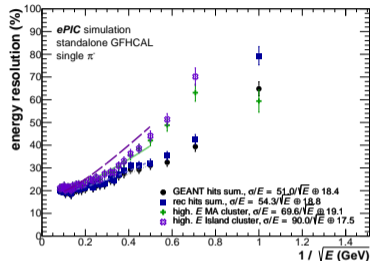
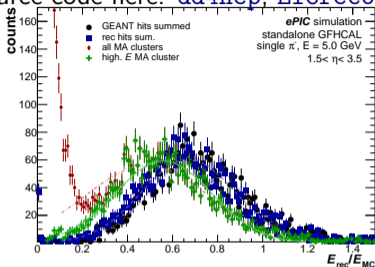
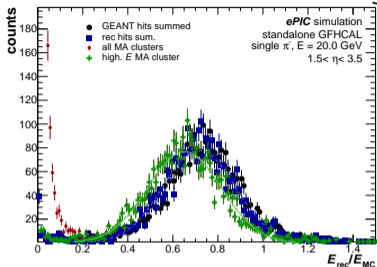

- Full implementation of hit chain (including basic noise simulation) & first version of clustering
- All simulations done with only HCal & single particle simulations
- Resolution calculated with time & energy cut offs
- Fitting restricted to > 4 GeV (as for CALICE data) resulting in more realistic $1/\sqrt{E}$ - term
- Significantly larger constant term than for LFHCal

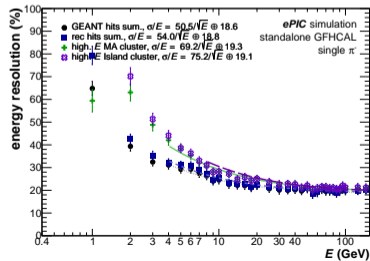

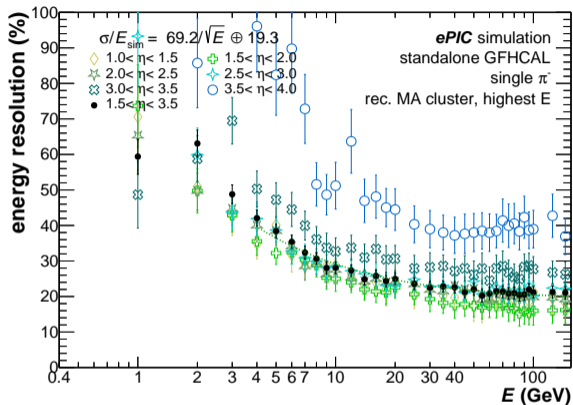
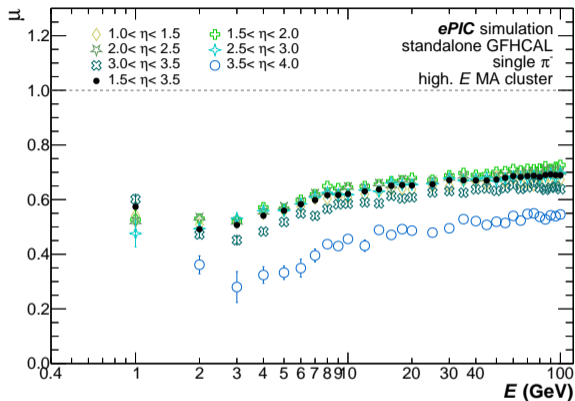

- Current implementation without insert
- Mild eta dependence $1.0 < \eta < 3.0$
- significant losses beyond $\eta = 3.0$, as expected

GFHCAL simulations vs phi

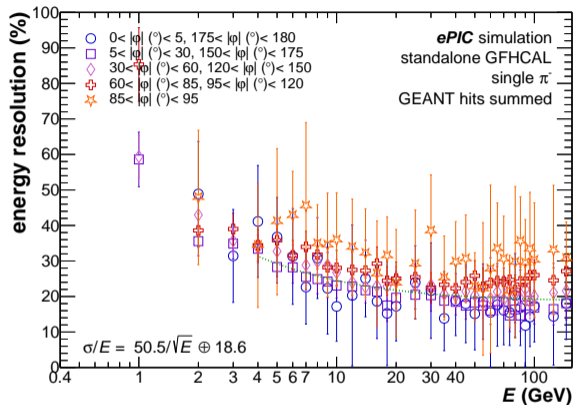
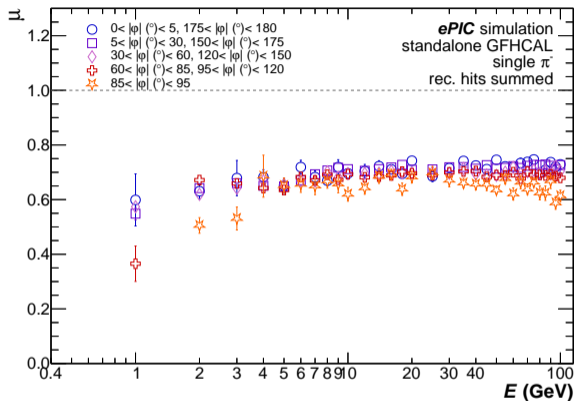

- Current implementation without insert
- Strong phi dependence, as expected (orange along y-axis, blue along x-axis)

GFHCAL simulations (m. layers) vs eta

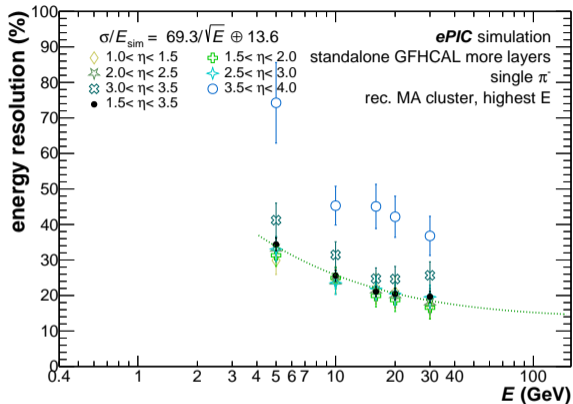
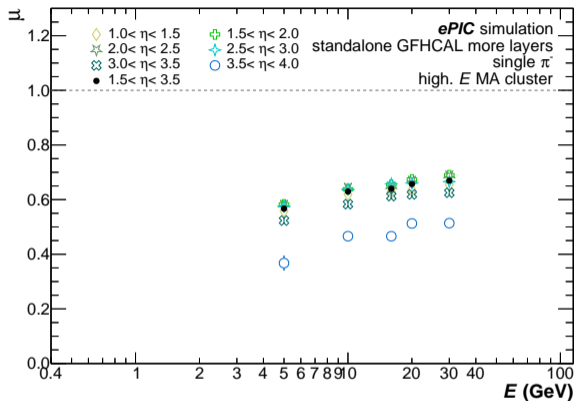

- Current implementation without insert
- Mild eta dependence $1.0 < \eta < 3.0$
- significant losses beyond $\eta = 3.0$, as expected
- Improved constant term compared to default setup

Understanding the simulations (1)

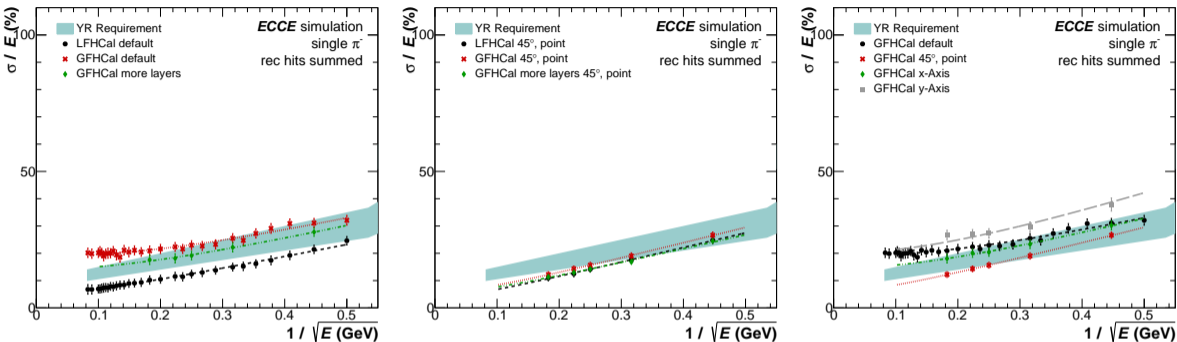

- Left: Comparison of different detector setups full η/φ
- Middle: Comparison of different detector setups at 45° in center of detector
very similar performance GFHCAL more layers & LFHCAL
- Right: Comparison of default GFHCAL in different regions
Significant losses along y-axis (channeling) and even along the x-axis
Particle hitting center of detector similar performance as LFHCAL

Backup Different Options



Option 1 (Default)

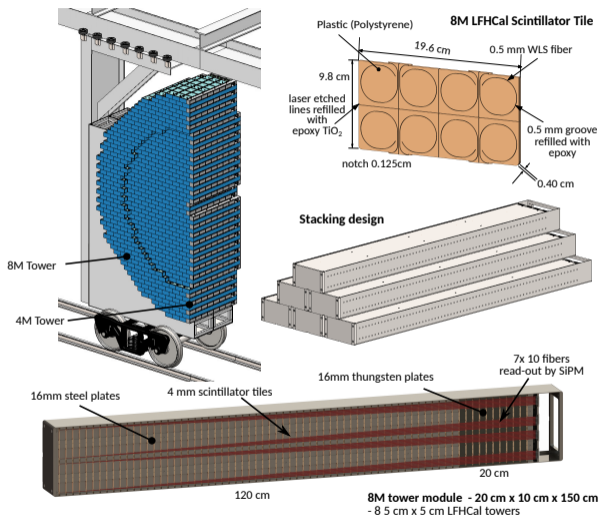

Concept:

- PSD [link TDR] inspired inspired Fe/W-Scint calorimeter
4 layers of W (160 mm)-Sci plates (4mm) 61 layers of Steel (160 mm)-Sci plates (4mm) +
- Multiple towers combined in one module to reduce dead areas, increase granularity
- WLS fibers running into each tile, read out at the end
- Read-out:
 - ▶ 7 signals per tower (signals combined from 10 Sci-plates, 5 in tungsten section)
 - ▶ 63.3K channels read out
- Modules of different sizes (8M, 4M, 2M, 1M) to maximize coverage & assembly efficiency

Option 1b (Buried SiPM)

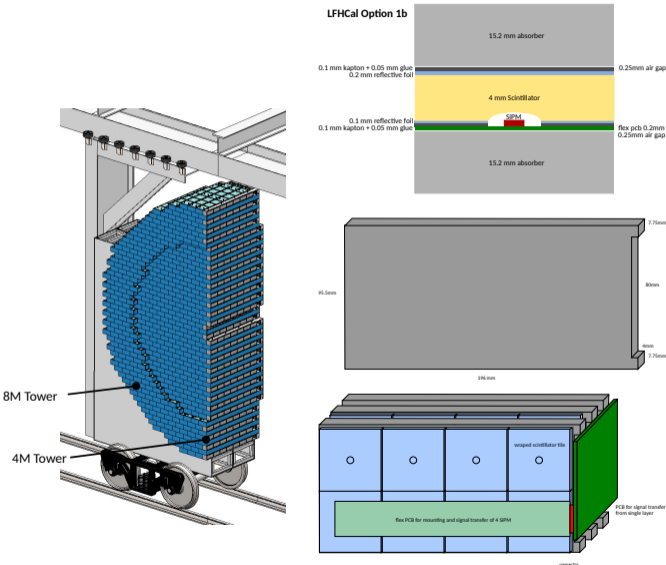

- Same general design as LFHCal option 1 replacing WLS fibers in each layer with SiPM on tile option and single wrapped tiles (5x5cm)
- Transfer of signals via small flex PCB to side of 8M module + long PCB to the end
- Signal summing of individual SiPMs at the end, same readout granularity at the end
- FEB boards removable similar to option 1, SiPMs not
- Simplified machining of absorber plates
- Upgrade option 1b+: Readout every SiPM by adding more HGCROCs & removing summing board, liquid cooling would be needed

Option 2 - GFHCaI

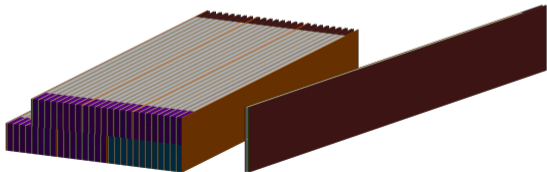
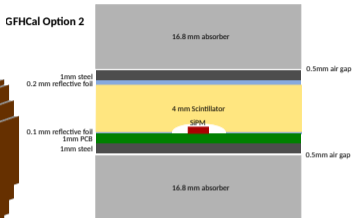
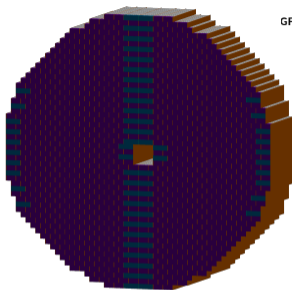

- Outer module dimensions + stacking stay largely the same replacing 4M with 12M modules
- Internal module design rotated by 90° absorber running in z direction
- Electronics + Scintillator tiles pulled out towards the back in cassettes
- SiPM on tile option with 5x5cm tiles
- Transfer of signals via long flex PCB to the end
- HGCROCs sitting in the back of HCal, cooling needed only in the back
- Signal summing of individual SiPMs at the end (2 tiles each) → increased granularity
- Simplified machining of absorber plates compared to option 1
- Upgrade option 2b+: Readout every SiPM by adding more HGCROCs & removing summing board, more liquid cooling would be needed

Option 3 - Full casset design

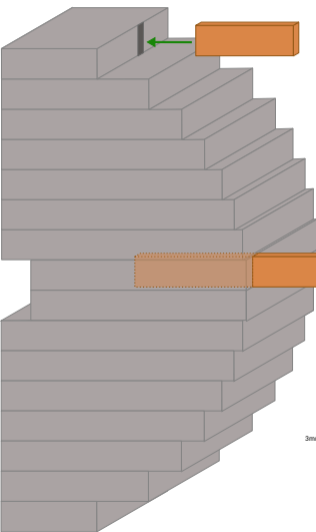

- Full redesign of everything
- Closest concept to HGCCal or CALICE AHCal SiPM on tile (5x5cm) & could incorporate insert with higher granularity
- Absorber structure of half detector (shell) + cradle build as a whole with slots on side for insertion of cassetts
- Cassetts ~ 30cm x 250cm in worst case (center) with all scintillators + readout electronics inside

LFHCAl Option 3

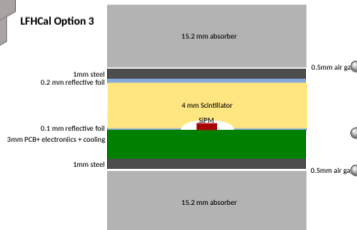

- HGCROCs would need to be integrated in layers
- Cooling absolutely necessary in layers
- Electronics + SiPM servicable no ganging trivially possible

Comparison layer thickness

LFHCal Option 1

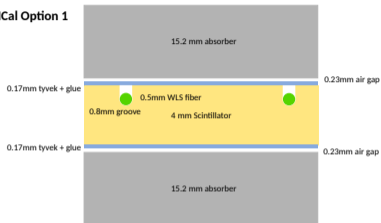

LFHCal Option 1b

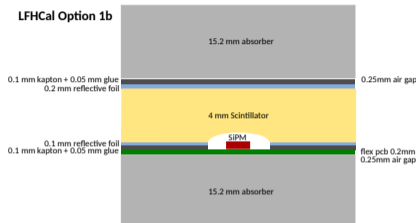

GFHCal Option 2

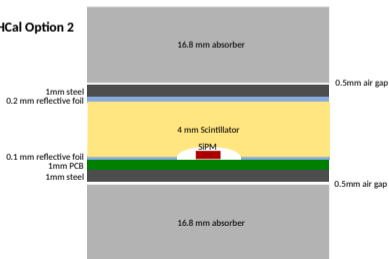

LFHCal Option 3

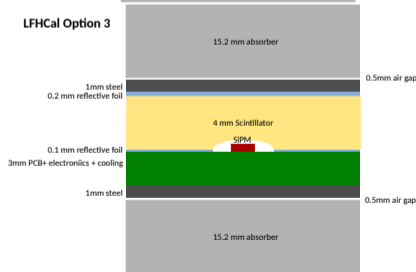

- Due to different needs, i.e. connections, cooling, readout out significant differences in sampling fraction
- Can't be fully adapted by changing layer thickness of steel/thungsten

Electronics comparison

	Option 1	Option 1b	Option 1b+	Option 2	Option 3
Channel #	63,280	63,280	601,160	253036	601,160
SiPM \$	63,280; 3x3mm 506	601,160; 1.5x1.5mm 4210	601,160; 1.5x1.5mm 4210	506,072; 1.5x1.5mm 3550	601,160; 1.5x1.5mm 4210
Summing board	No	Yes (10channel)	No	Yes (2channel)	No
# HGCROC (FEB) k\$	~1,100 22	~1,100 22	~10,450 210	~4,500 90	~10,450 210
ECON-D (FEB) k\$			1,800 9	750 1.5	1,800 9
FPGA (RDO) k\$	46 90	46 90	90 180	37 150	90 180
PCB	135	135	270	113	270
Cooling	0	back	back	back/inner	inner
Cables, etc	?	?	?	?	?
Total cost k\$	753	4457	4880	3829	4880

Main Questions option 1b & 2

- Can one drive & readout the SiPM over $> 1\text{m}$ using PCB or capton flex without applification?
- If not cooling might become necessary
- Do we wanna gang SiPMs
- Do we wanna go for injection molded tiles'?
- For option B, what does it to the physics?

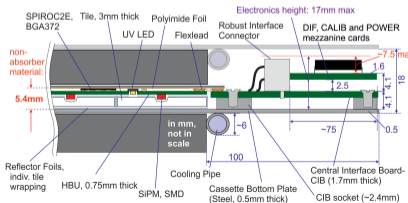
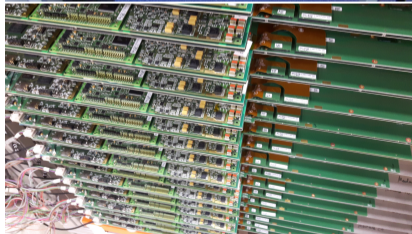
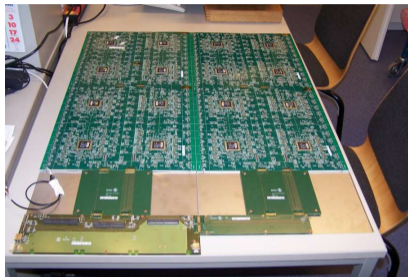

CMS:

- In full cryo container, liquid Nitrogen
- No possibility to service HGCROCs or SiPMs ever

AHCal:

- Cassetts with fully integrated electronics ~ 6mm on inside, 3mm electronics
- Clearance around casset ~ 1 mm on both sides

Costing



Updated Cost Estimate - option 1

Example 8M module costs:

Material procurement	Units	Unit Pricing
Absorber plates W	4	\$445
Absorber plates Steel	61	\$60
module support	1	\$320
Scintillator plates	65	\$65
tyvek + capton	4.04	\$0.4
WLS fibers	1360	\$2
8M module cost:	1091	\$12770

Assembly labor	hours	cost
installing fiber mech. engineer	17.5 h	\$2680.5
tile wrapping PhD students	7 h	\$140
tower assembly mech. engineer	0.083 h	\$12.8
tower assembly PhD Student	1.92 h	\$38.4
tower assembly Undergrad	11 h	\$220
tower testing Postdoc	1 h	\$71
tower testing PhD Student	4.5	\$90
8M module cost:	1091	\$3252.7

Electronics	Units	Unit Pricing
SiPMs	56	\$8
SiPM mounting + summing boards	1	\$90
HGCROC	1	\$20
cable+HV/LV	1	~\$822
8M module cost:	1091	\$1392

Additional costs:

- R&D cost: 393K
- Tooling: 200K
- Support Structure: 100K
- Installation: 382K
- FPGAs: 90K

Total costs:

- estimated for:
1091x8M module, 76x4M modules, 2x2M modules, 4x1M modules
- Module prices don't exactly scale as labor doesn't scale
- Cost adapted to most recent quotes for 8M steel, WLS, tungsten (not included before), scintillator with realistic design
- Labor hasn't been modified
- **total unescalated cost: \$20.7M**

Updated Cost Estimate - option 1b

Example 8M module costs:

Material procurement	Units	Unit Pricing
Absorber plates W	4	\$364
Absorber plates Steel	61	\$45
module support	1	\$320
Scintillator tiles (wrapped)	520	\$7
reflective wrap	4.04	\$50
flexcables	130	\$2
SiPMs	520	\$7
8M module cost:	1091	\$12003

Assembly labor	hours	cost
tower assembly mech. engineer	0.083 h	\$12.8
tower assembly PhD Student	2 h	\$40
tower testing Postdoc	1 h	\$71
tower testing PhD Student	4.5	\$90
8M module cost:	1091	\$213.8

Electronics	Units	Unit Pricing
FEB + summing boards	1	\$20
HGCROC	1	\$20
cable+HV/LV	1	~\$822
8M module cost:	1091	\$1392

Additional costs:

- R&D cost: 393K
- Tooling: 200K
- Support Structure: 100K
- Installation: 382K
- FPGAs: 90K
- Robotic assembly: 460K

Total costs:

- estimated for same as std. option 1
- Assumed cost for absorber in option 1, 0.5 machining, scaled to 0.25
- not costed: long PCB on side, connectors layers & high density, testing of electric components and SiPMs, LEDs for each tiles
- **total unescalated cost: \$16.8M**

Thanks!

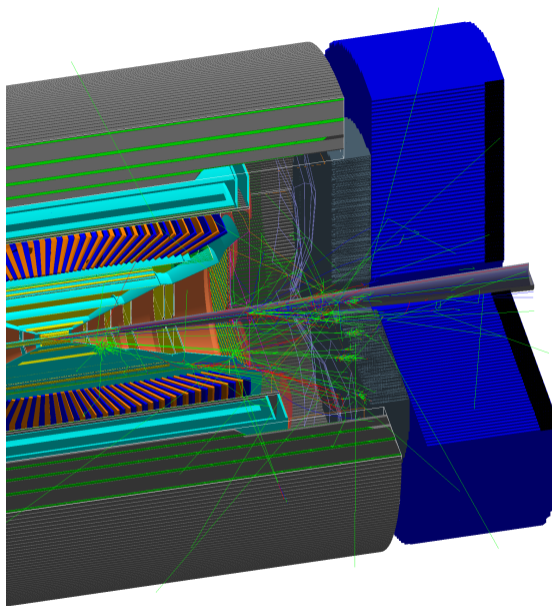

Current 8M Scintillator Plate Design

- Most scintillator plates produced as 1 unit of 100x200mm plates (8 single tower tiles)
- Separation of tiles edged into the plate (95%) through, refilled with Epoxy-TiO₂ mix
- Wrapped in Tyvek paper and Kapton tape or painted with TiO₂ rich paint

- Fiber thickness chosen for minimal light loss while bending (0.5mm)
→ other geometries for embedding under consideration (i.e. 1/4 circle)
- Originally costed from Uniplast as 1 unit of assembly + material
- Updated estimate including (material, fiber installation by engineer, wrapping by students, tooling)
→ new estimate driving by labor for fiber installation
- Exploring possible robot supported options for tile assembly

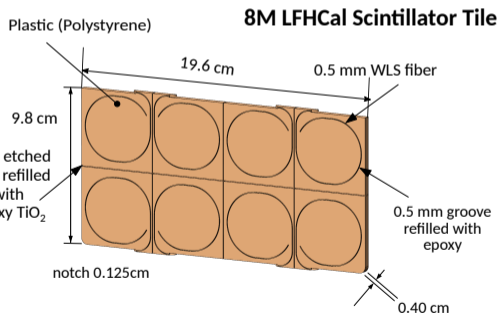

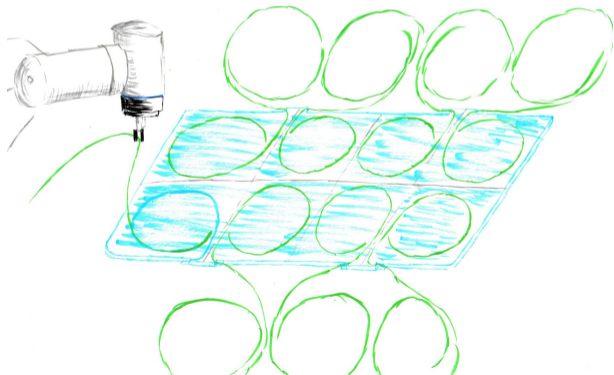
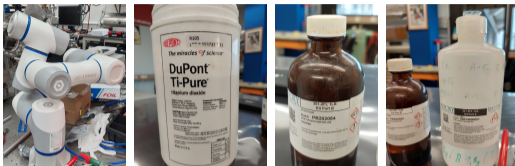

- ① Refilling of gaps with TiO_2 -Epoxy mix using collaborative robot
- ② Measuring fiber quality & cutting to desired length
- ③ Laying WLS-fibers in groove, fixating them using a few glue dots
- ④ Roll WLS-fibers up on tray with tile
- ⑤ Might need additional coating with white paint
- ⑥ Stack trays & transport to 8M assembly site

8M assembly detail

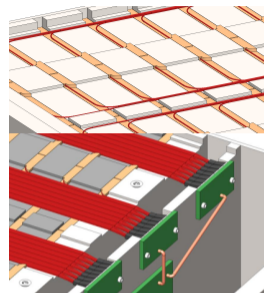
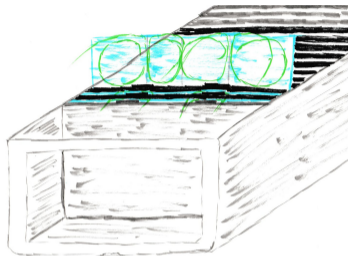
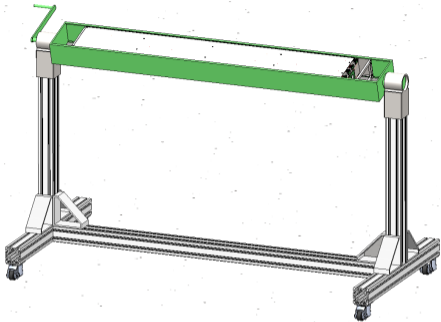

- Mount assembled steel/tungsten frame in pivot
- Slot scintillator tiles in frame from back to front
Fibers for bottom side slotted through, caught by tray on bottom
- After 10 tiles sort fibers 5/5 & place plastic strip as separator, tape on top
- Continue till top side finished & cut length of fibers to fit readout
- install cover plate
- Flip module in pivot, remove tray
- Sort fibers & assemble as on top

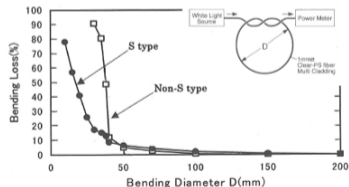

MC

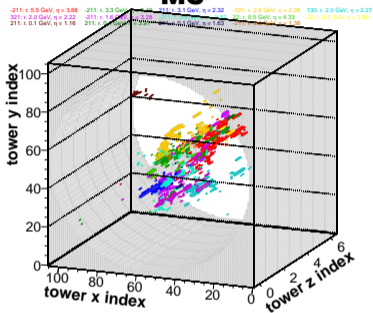

LFHCal, Event 30
e-p: 18x 275 GeV, $Q^2 > 100$ GeV

Rec

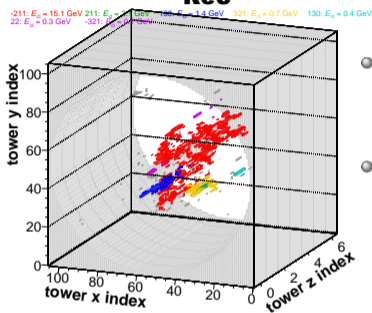

LFHCal, Event 30
e-p: 18x 275 GeV, $Q^2 > 100$ GeV

- High granularity needed to try to distinguish shower maxima close to beam pipe
- **HCal:**
read out in 7 layers longitudinally
desirable min measurable tower energy 3-5 MeV, max 20-30 GeV in single tower segment

- LFHCal 1 SiPM per 10 fibers (7 per tower) -i.e Hamamatsu S13360-3025PE (14.4K pixels)
- HCal readout at end of module (max. 10cm)
- Small light collection prisms might be needed in front of SiPM
- Idea use each 1 H2GCROC3 (up to 70 channels) for readout of HCal (ideally common chip/board design with WSciFi-ECal & ALICE FoCal-H)

Current Read-out Concept

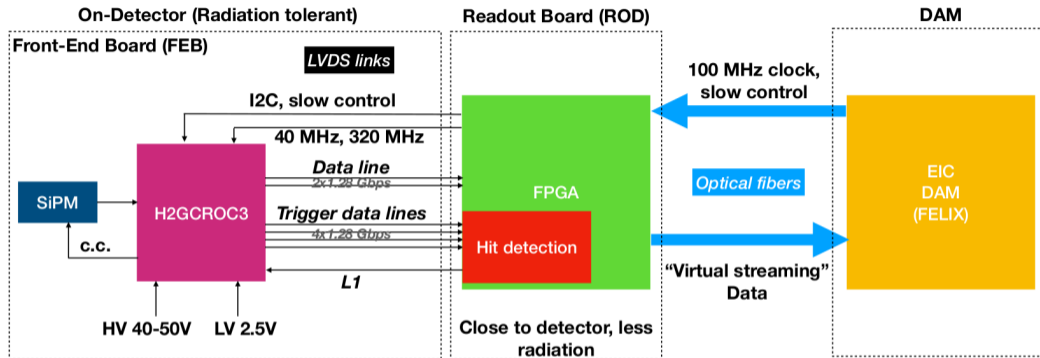

- The H2GCROC3 requires the L1 trigger for readout, with the maximum speed of 960 kHz
- The expected hit rate in one channel of LFHCal is up to 50 kHz:
 - ▶ With possible 4 sample readout we would reach a maximum of 200 kHz
 - ▶ "Virtual" streaming readout towards the EPIC DAQ system

GEANT Implementation Fun4All

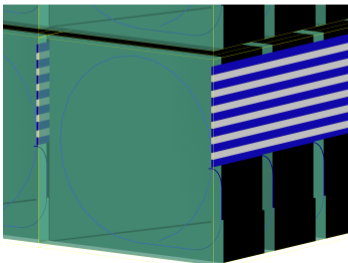
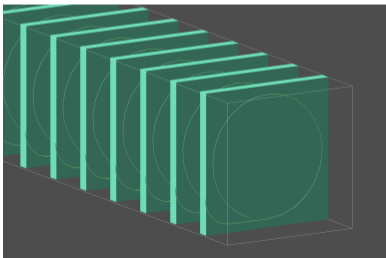
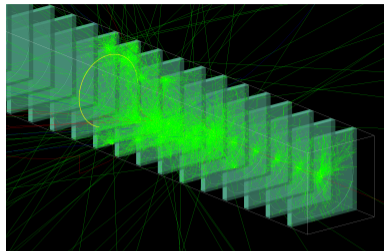
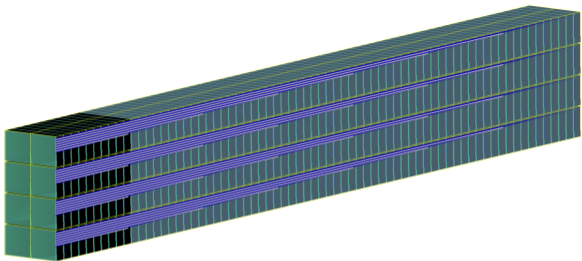

- largely realistic implementation of geometry , refinements for module edges needed
- first light propagation studies, cross checks planned with test sub-tiles at ORNL (fiber routing)

LFHCAL Performance

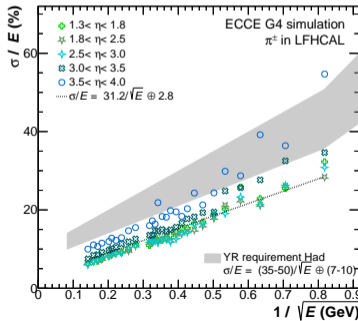
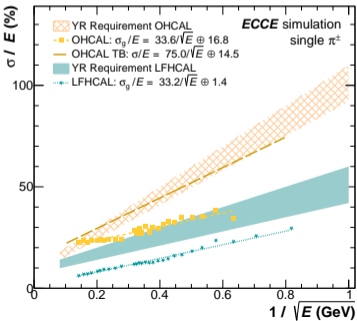
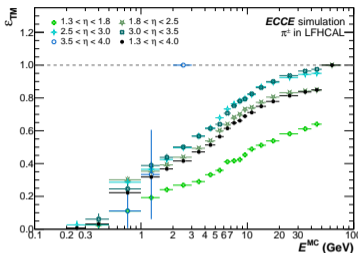
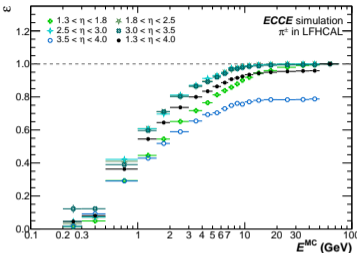

- Cluster finding and track matching efficiencies good in center of LFHCAL, losses towards edges
- Performance overestimated with standard response implementation in GEANT4 (1.5x from other setups)
- Small η dependence for energy resolution
- Exploring possibility for high granularity insert with different composition & changing granularity of readout as function of R
- Studies to improve clusterization further using ML started

R&D activities & plans



① Prototype tile production using machining & injection molding (04/23)

- ▶ Assembled prototype tiles using machined scintillator plates
- ▶ Assembled prototype tiles using injection molded scintillator tiles
- ▶ Documentation of procedures for manual assembly of tiles & WLS fibers

② Reconstruction optimization (09/23)

- ▶ Write-up of optimization results from simulations

③ Sensor board development (07/23)

- ▶ First prototype of sensor board for Si-PM readout (together with eRD109)

④ Small test module assembly (07/23)

- ▶ First prototype of single segment of 8M module

⑤ First automated scintillator tile assembly (08/23)

- ▶ Assembled prototype tiles
- ▶ Documentation and Evaluation of procedures for automated assembly of tiles & WLS fibers

⑥ Tile Characterization (08/23)

- ▶ Write-up of test bench & test beam measurement for all assembled tile-prototypes

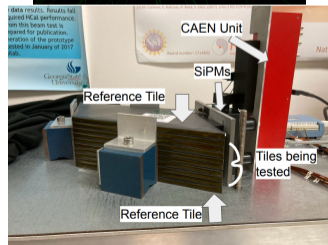
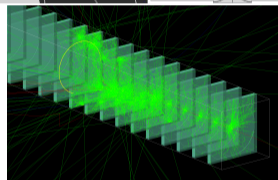
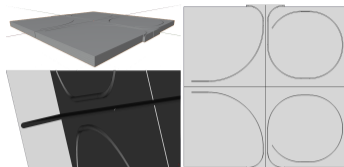

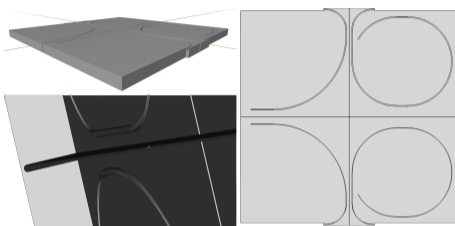
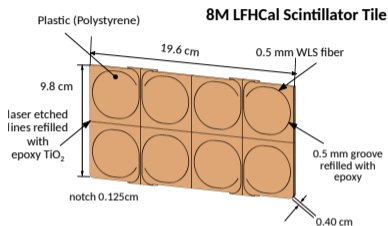

Prototype tile production using machining & injection molding

- Vendor replacement needed for Uniplast
 - a) Machining plastic scintillator plates (~ \$80/tile)
 - b) Injection molding tile (~ \$4 – 6/tile)
- Opportunity for significant cost reduction w/ injection molding
- Performance and mechanical stability tests needed in both cases

First automated scintillator tile assembly

- Tile assembly time & labor extensive w/ classical methods
- Exploring automated assembly using collaborative robots for:
 - ▶ Refilling sub-segmentation with TiO₂
 - ▶ Fiber laying and fixating in groves
 - ▶ Automatic measurements of WLS-fiber quality

- Characterization of assembled tiles according to:
 - ▶ Light yield
 - ▶ Cross-talk among different tiles
 - ▶ Response uniformity
 - ▶ Durability and mechanical stability
- Initial geometry optimization using TracePro simulations
- Usage of available test-stands at universities for tile characterization
- Possibility to test multiple scintillator materials/dopant concentration in particular for injection molding
- Development of a SiPM board and WLS fiber connector suitable for production module

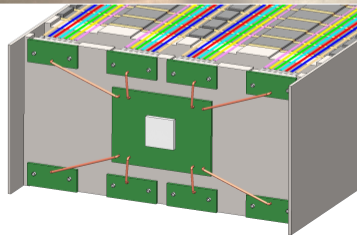
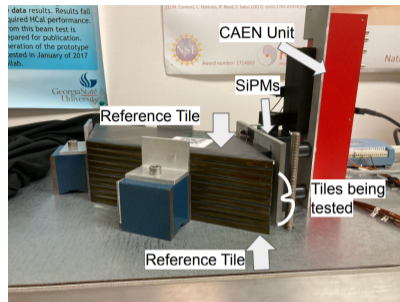

- Successively-larger R&D prototype assembly
 - ① Scintillator tiles
 - ② Single segment of 8M module (20cm) including initial read-out design
 - ③ Full mechanical mock-up of 8M module
 - ④ Full 8M modules including initial read-out design
- Main measurements
 - ▶ Characterization of spatial distribution and uniformity of MIP response for different tile types
 - ▶ Saturation behavior of combined tile and SiPM readout system for single segment
 - ▶ Measuring the individual and combined response of tiles to EM-showers
 - ▶ Spatial and energy resolution of partial and full module LFHCAL module
 - ▶ Combined test-beam w/ pECal to characterize LFHCAL partial and full module response behind ECal
- Current Read-out electronics design based on CMS-SiPM-HGCROC (ASIC)
Final electronics R&D for EIC specific readout board within eRD109 based on same ASIC with possible small modifications

eRD107 Funding request

activity	cost in FY23 k\$									total cost in FY23 k\$
	ORNL	FNAL	BNL	UTK	GSU	Yale	ISU	Valpo	UCR	
Machined Tiles	11.7	0	0	0	0	0	0	0	0	11.7
Injection Molded Tiles	2.0	52.9	0	0	0	0	0	0	0	54.9
Auto Tile Assembly	20.0	0	0	0	0	0	0	0	0	20.0
Tile Char. (Lab)	16.0	0	0	0	0	0	0	0	0	16.0
Sensor Board	12.2	0	0	0	0	0	0	0	0	12.2
LFHCAL Mechanics	21.7	0	0	0	0	0	0	0	0	21.7
Tile Char. (Beam)	1.0	0	2.0	2.0	2.0	2.0	2.0	1.0	2.0	14.0
Total	84.6	52.9	2.0	2.0	2.0	2.0	2.0	1.0	2.0	150.5

institute	cost in FY23 k\$				total cost in FY23 k\$
	eng. and tech.	material	equipment	travel	
ORNL	29.8	16.8	36.0	2.0	84.6
FNAL	52.9	0	0	0.0	52.9
BNL	0	0	0	2.0	2.0
UTK	0	0	0	2.0	2.0
GSU	0	0	0	2.0	2.0
Yale	0	0	0	2.0	2.0
ISU	0	0	0	2.0	2.0
Valpo	0	0	0	1.0	1.0
UCR	0	0	0	2.0	2.0
Total	82.7	16.8	36.0	15.0	150.5

- Largest fraction of funding for engineers and technicians
- Additional funds used for material, test equipment & travel for test beam campaigns
- Significant in-kind contribution from universities and laboratories for assembly, simulation and data analysis (~ 2140h)
- Parallel PED request for mechanical & electrical engineering support will be submitted to further final design of LFHCAL

Task	Estimated cost in \$ per year		
	FY24	FY25	FY26
mechanical engineering	40K	40K	20K
electrical engineering	30K	30K	20K
materials	30K	30K	40K
test beam support	10K	10K	10K
total	110K	110K	90K

Calorimeter Details & PED request

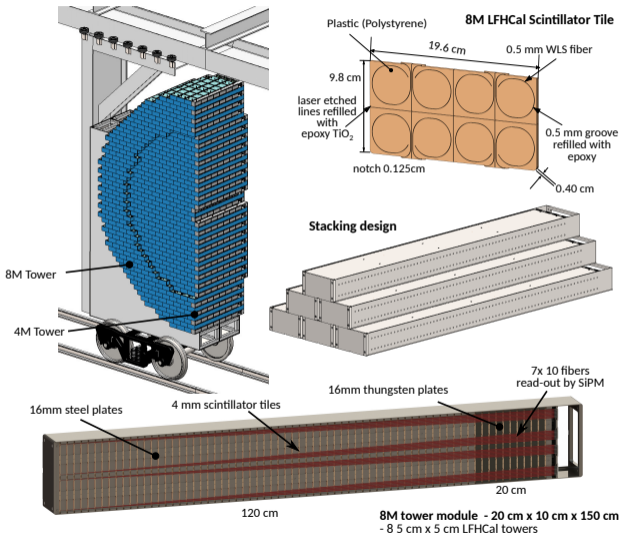

parameter	LFHCal
inner radius (envelope)	17 cm
outer radius (envelope)	270 cm
η acceptance	$1.2 < \eta < 3.5$
tower information	
x, y ($R < / > 0.8$ m)	5 cm
z (active depth)	140 cm
z read-out	10 cm
# scintillator plates	70 (0.4 cm each)
# absorber sheets	60 (1.6 cm steel)
	10 (1.6 cm tungsten)
weight	~ 30.6 kg
interaction lengths	$6.9 \lambda / \lambda_0$
Molière radius R_M	21.1 cm (π^\pm shower)
Sampling fraction f	0.040
# towers (inner/outer)	9040
# modules	
8M	1091
4M	76
2M	2
1M	4
# read-out channels	$7 \times 9,040 = 63,280$

activity	cost in FY23 k\$		total cost in FY23 k\$
	ORNL	BNL	
Support structure design & integration with pEcal	75	0	75
Rail/slide design	0	50	50
test production of module	20	0	20
tooling design + function test	50	0	50
Total	145	50	195

8M assembly

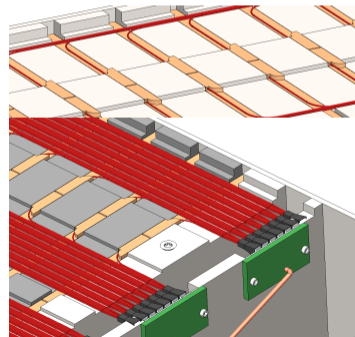
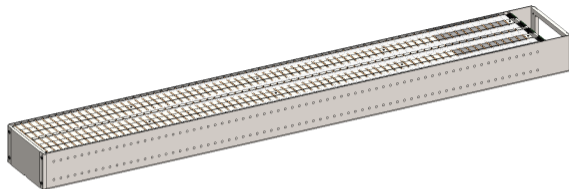
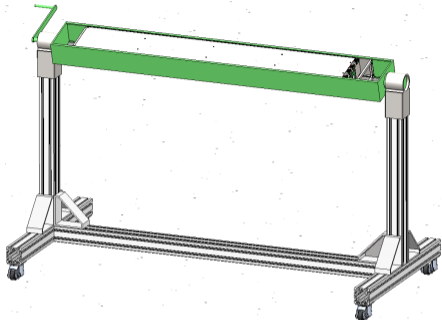

- a) single tile assembly (fiber embedding, glueing, wrapping)
- b) tile testing
- c) assembly of module, alternating steel plate first kept in place by e-beam point welding then Scint-tile
- d) fiber channels layed out on front on back
- e) SiPM & read-out card installation
- f) tower testing
- g) close up module with cover plates

eRD107: Detailed cost table

Institute	Item	Cost per item in \$	Number of items	Total cost in \$	To be compl. by
Machined Scintillator Tiles:					
ORNL	BC-408 plastic scintillator sheet	~ 150	20	3K	Q1/2023
ORNL	BCF-91A WLS fiber	1500	1	1.5K	
ORNL	tile machining	180/h	40h	7.2K	Q4/2022
ORNL/UTK	tile assembly		40h	(in kind) 0K	Q4/2022
Injection Molded Scintillator Tiles:					
FNAL	mold design + production	50 000	1	50K	Q2/2023
ORNL	travel			2K	Q4/2022
FNAL	raw material + dopant			(in kind) 0K	
FNAL	injection molder setup + operation	180/h	16h	2.9K	Q1/2023
ORNL/UTK	tile assembly		40h	(in kind) 0K	Q1/2023
Automated Tile Assembly:					
ORNL	robotic arm	20 000	1	20K	2024
ORNL	robot programming and evaluation		40h	(in kind) 0K	Q3/2023
Tile Characterization (Lab Bench):					
ORNL/UTK	scintillator material characterization		20h	(in kind) 0K	Q3/2023
ORNL	waveform sampling readout (8ch)	16000	1	16K	Q2/2023
GSU/Yale/UCR	tile lightyield testing		160h	(in kind) 0K	Q3/2023
ISU/BNL	tile simulation		160h	(in kind) 0K	Q3/2023
Sensor Board:					
ORNL	mechanical engineer	180/h	15h	2.7K	Q1/2023
ORNL	sensors: silicon photomultipliers	30	300	9K	
ORNL	sensor board production, assembly	50	10	0.5K	Q1/2023
Reconstruction Optimization:					
UTK/Yale/BNL	simulations/digitization/reconstruction/analysis		640h	(in kind) 0K	2025
LFHCAL Mechanics:					
ORNL	mechanical engineer	180/h	105h	18.9K	Q3/2023
ORNL	absorber material + fasteners	40	70	2.8K	
UTK/Yale	absorber machining	100/h	20h	(in kind) 0K	Q2/2023
Tile Characterization (Test Beam):					
ORNL	assembly and shipping			1K	Q3/2023
All	test beam travel			13K	
ORNL/UTK	test beam preparation		80h	(in kind) 0K	Q2/2023
ORNL	test beam		120h	(in kind) 0K	Q3/2023
Yale	test beam		120h	(in kind) 0K	Q3/2023
BNL	test beam		120h	(in kind) 0K	Q3/2023
UTK	test beam		120h	(in kind) 0K	Q3/2023
GSU	test beam		120h	(in kind) 0K	Q3/2023
ISU	test beam		120h	(in kind) 0K	Q3/2023
Valpo	test beam		120h	(in kind) 0K	Q3/2023
UCR	test beam		120h	(in kind) 0K	Q3/2023
Total				150.5K	