

# SVT DSC and Tracking Workfest Report

Ernst Sichtermann (LBNL)

# Reminder: ePIC Tracking and Vertexing Subsystems

Matt Posik (Temple U.)



## ePIC Central Tracking Layout Overview: Crater Lake

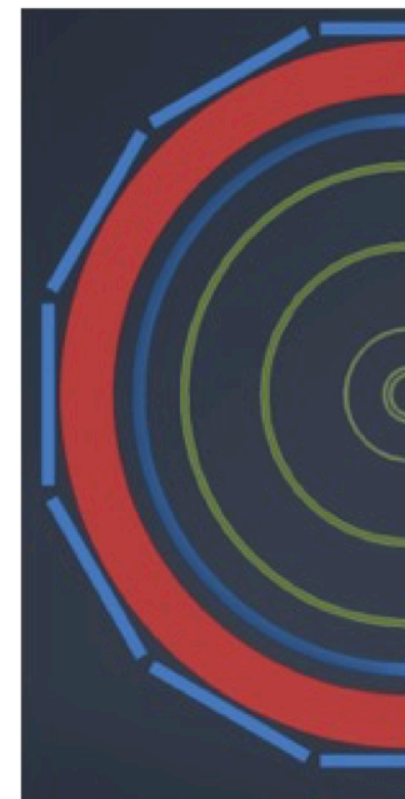
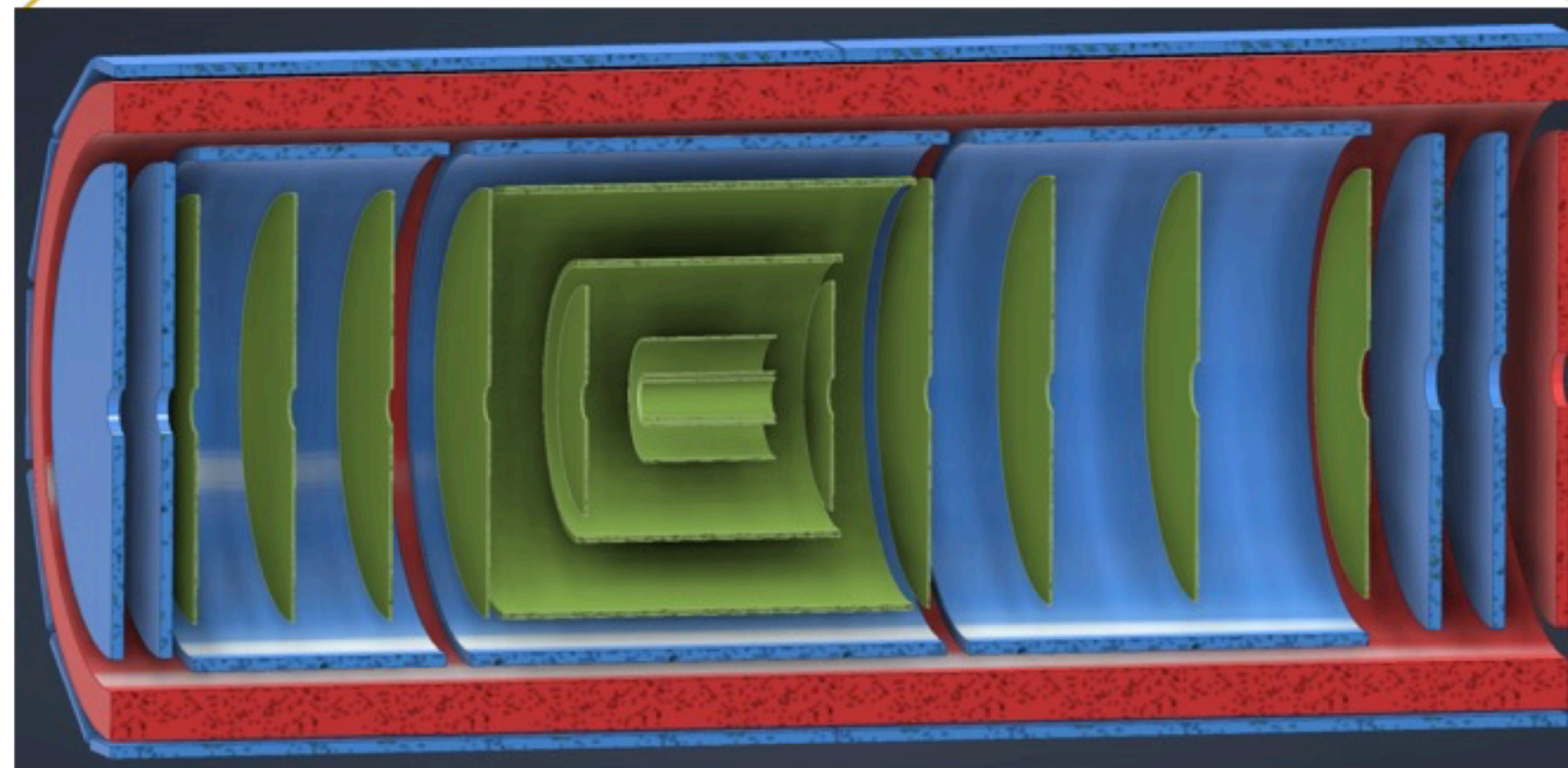
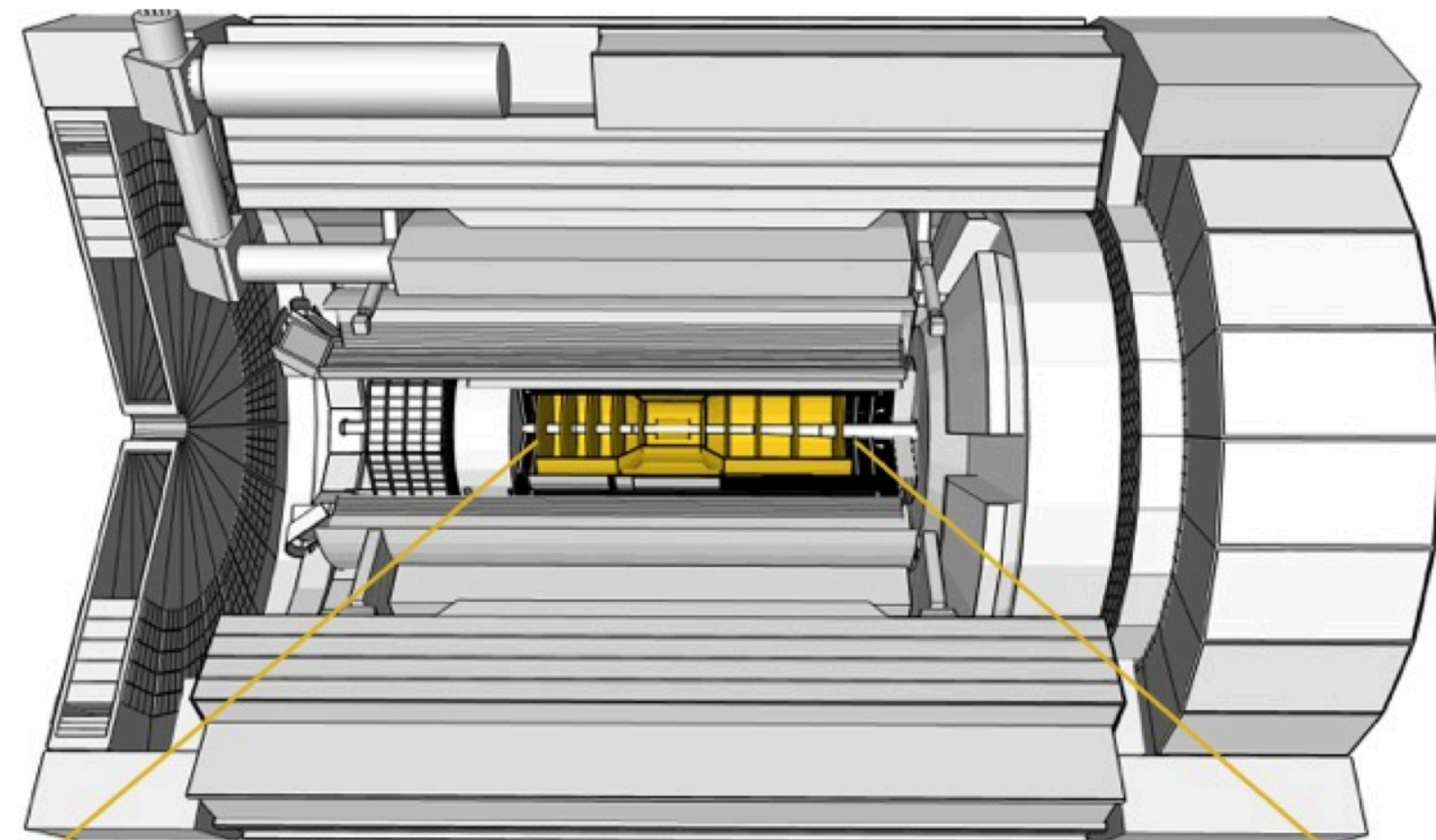

- ❑ ePIC tracking system is a hybrid of silicon and gaseous technologies
- ❑ **MAPS Layers**
  - Make up inner tracking volume
  - Highly granular and low mass layers to provide excellent momentum resolution and precision pointing resolution
- ❑ **MPGD Layers**
  - Large area detectors are instrumented in the outer tracking volume
  - Provide timing and pattern recognition
  - Planar detectors can provide impact point and direction for PID seeding
- ❑ **AC-LGAD**
  - Fast detector to provide low momentum PID.
  - Can provide an additional space point for pattern recognition/redundancy
- ❑ **Barrel Imaging Calorimeter (BIC)**
  - Provide additional hit point
  - Potential to help with PID seeding and pattern recognition

■ MAPS Barrel + Disks   ■ MPGD Barrels + Disks  
■ AC-LGAD based ToF



# SVT Workfest: MAPS Barrel + Disks

Organized as:

- three half-days — mornings so as to facilitate remote participation
- themed session blocks
- parallel-session style talks and discussion time

Lots of work/discussions in the afternoons

Workfest was very productive — exactly as intended

Success Factors:

- everyone who actively participated
- in-person interactions,
- remote participation, facilitated by overall meeting logistics
- well-prepared parallel-session style talks *and* discussion time in the mornings
- many good questions

Thanks to all who participated and local organization!

# SVT Workfest: Tuesday — Sensor; Readout & power

**8:00 AM** → 9:45 AM **SVT DSC: sensor** 📍 A5000 (APS Conference Cent...

[Zoom connection](#)

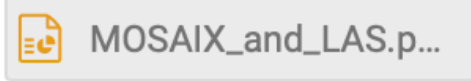
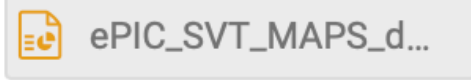

**Conveners:** Ernst Sichtermann (Lawrence Berkeley National Laboratory), **Laura Gonella** (University of Birmingham)

- 8:00 AM** **Welcome and introduction** ⌚ 5m  
**Speakers:** Ernst Sichtermann (Lawrence Berkeley National Laboratory), **Laura Gonella** (University of Birmingham)
- 8:05 AM** **Radiation and rate environment** ⌚ 20m  
**Speaker:** Laura Gonella (University of Birmingham)  

- 8:25 AM** **MOSAIX and EIC LAS (remote)**  
**Speaker:** Iain Sedgwick (UKRI-STFC)  

- 8:55 AM** **EIC-LAS ancillary / support IC**  
**Speaker:** Grzegorz Deptuch (BNL)  

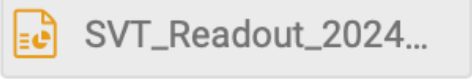
- 9:25 AM** **Discussion on sensor and IC**

**10:15 AM** → 12:00 PM **SVT DSC: readout, power** 📍 A5000 (APS Conference Cent...

[Zoom connection](#)

**Conveners:** Ernst Sichtermann (Lawrence Berkeley National Laboratory), **Laura Gonella** (University of Birmingham)

- 10:15 AM** **Readout of the ePIC SVT (remote)** ⌚ 40m  
**Speaker:** Joachim Schambach (Oak Ridge National Laboratory)  

- 10:55 AM** **Discussion on readout of the ePIC SVT** ⌚ 15m
- 11:10 AM** **Basics of serial powering and S-LDO** ⌚ 15m  
**Speaker:** Laura Gonella (University of Birmingham)  

- 11:25 AM** **Serial powering for the ePIC SVT** ⌚ 20m  
**Speaker:** James Julian Glover (University of Birmingham (UK))  

- 11:45 AM** **Discussion on serial powering for the ePIC SVT** ⌚ 15m



# SVT Workfest: Wednesday — Sensor characterization; Cooling

(First morning session was joint with the Jets and Heavy-flavor and the Tracking WGs; it is covered in a later summary report)

**10:15 AM** → 12:00 PM **SVT DSC: sensor characterization, cooling** 📍 B4100 (APS Conference Cent...

[Zoom connection](#)

**Conveners:** Ernst Sichtermann (Lawrence Berkeley National Laboratory), Laura Gonella (University of Birmingham)

- 10:15 AM** | **Characterization of the SVT sensors and ancillary IC** 🕒 30m  
**Speaker:** Lukas Tomasek (employee@cvut.cz;member@cvut.cz;staff@cvut.cz)  
 SVT\_Sensor\_charac...
- 10:45 AM** | **Discussion on characterization for the SVT** 🕒 20m
- 11:05 AM** | **Inventory of SVT power dissipation** 🕒 5m
- 11:10 AM** | **Cooling of SVT layers and disks** 🕒 30m  
**Speaker:** Nicole Apadula  
 Apadula\_SVT\_Cooli...
- 11:40 AM** | **Discussion on SVT cooling** 🕒 20m

# SVT Workfest: Thursday — Electrical interfaces; mechanics; TDR

**8:00 AM** → 9:45 AM **SVT DSC: electrical interfaces, global mechanics** E1200 (APS Conference Cente...

Zoom connection

Conveners: Ernst Sichtermann (Lawrence Berkeley National Laboratory), Laura Gonella (University of Birmingham)

- 8:00 AM** **Consideration on SVT FPC design** 30m  
Speaker: Marcello Borri (staff@stfc.ac.uk)  
20240109-eicWp3F...
- 8:30 AM** **Discussion on FPC** 20m
- 8:50 AM** **Envelopes and constraints: knowns** 5m  
EPIC Envelope - 07-...
- 8:55 AM** **Global supports for the SVT**  
Speaker: Andreas Werner Jung (member@cern.ch)  
SVTmech-globalMe...
- 9:25 AM** **Discussion on global supports**

**10:15 AM** → 12:00 PM **SVT DSC: local mechanics, TDR** E1200 (APS Conference Cente...

Zoom connection

Conveners: Ernst Sichtermann (Lawrence Berkeley National Laboratory), Laura Gonella (University of Birmingham)

- 10:15 AM** **SVT layers and disks** 30m  
Speaker: Georg Viehhauser (member@ox.ac.uk;staff@ox.ac.uk)  
Local supports coll...
- 10:45 AM** **Discussion on SVT local mechanics** 20m
- 11:05 AM** **Inventory of services** 15m
- 11:20 AM** **Discussion and brainstorming** 20m
- 11:40 AM** **Next steps towards TDR and division of labor** 20m  
Speakers: Ernst Sichtermann (Lawrence Berkeley National Laboratory), Laura Gonella (University of Birmingham)  
20240111-TDR.pdf



# SVT Workfest: Environment

Laura Gonella (Birmingham)

## Fluence

- 1 MeV neutron equivalent fluence in the ePIC SVT region
  - Black lines show the **approximate position** of the SVT layers and disks
  - Note in particular that the inner radius of the disks will be larger for
- The majority of the SVT will see fluence levels **below  $10^{11}$   $n_{eq}/cm^2$**
- **HD**: fluence between  **$10^{11}$  and  $10^{12}$   $n_{eq}/cm^2$**  ; in the innermost part of HD2-4 fluence of a **few  $10^{12}$   $n_{eq}/cm^2$**
- **L0, L1**: fluence between  **$10^{11}$  and  $10^{12}$   $n_{eq}/cm^2$**

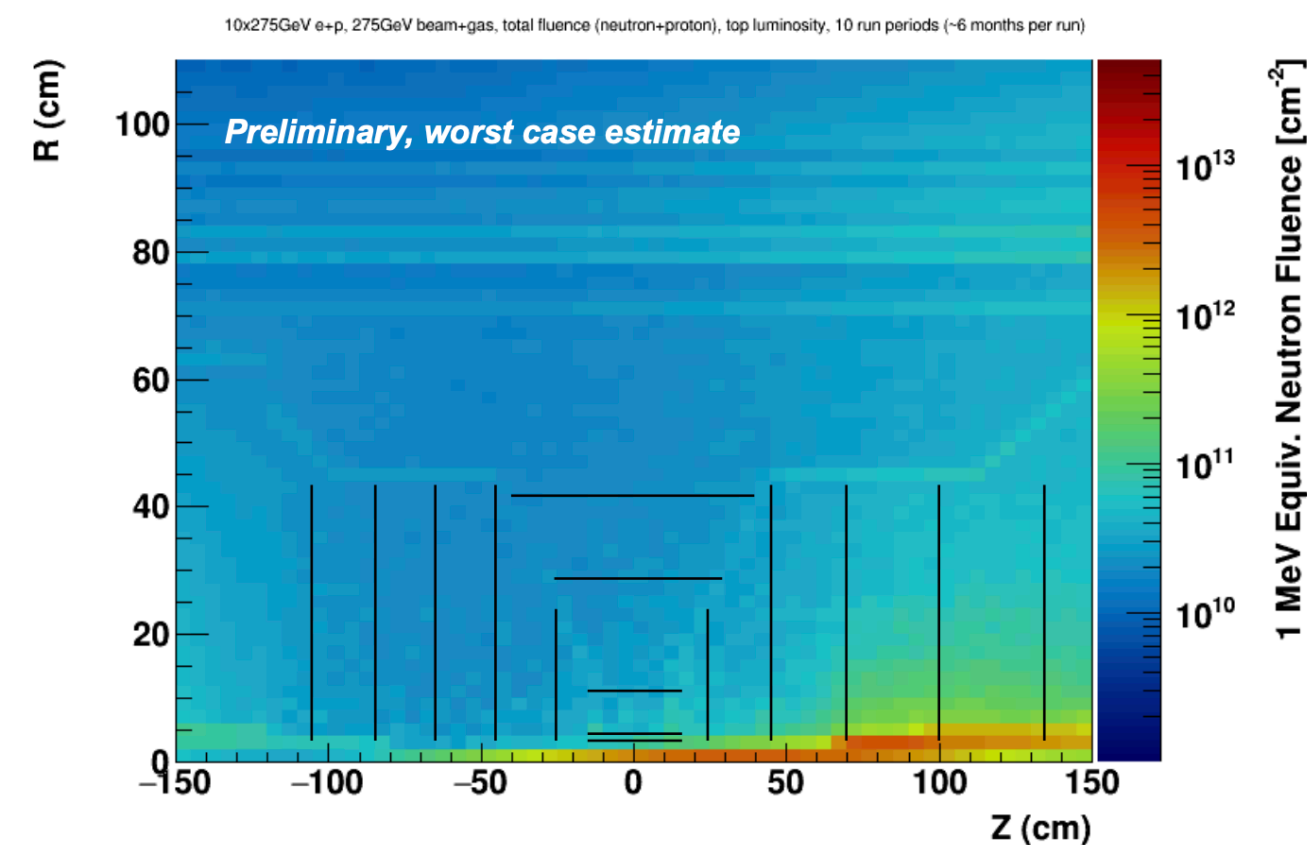

## Dose

- Dose in rad in the ePIC SVT region
  - Black lines show the **approximate position** of the SVT layers and disks
- Area close to the beam pipe will experience a total ionising dose **between 10 krad and a few hundred krad**
- The rest of the SVT remains **below 10 krad**

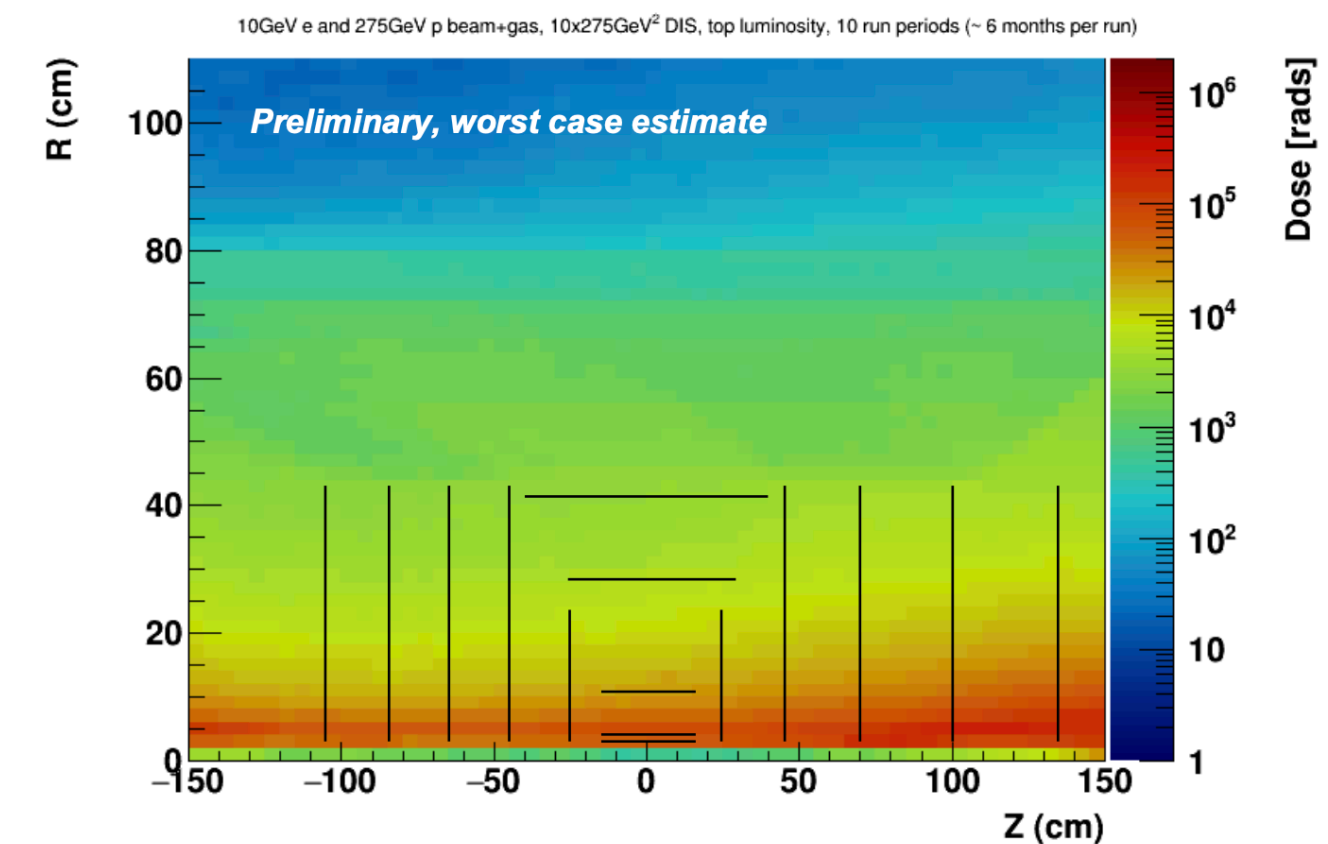

- Fluence and dose
  - Estimated for **worst case scenario** of running 10 years at top luminosity
  - Including electron and hadron beam gas; SR contribution not included
  - **Low to moderate levels**

# SVT Workfest: Environment

Laura Gonella (Birmingham)

## Hit Rates in the ePIC SVT

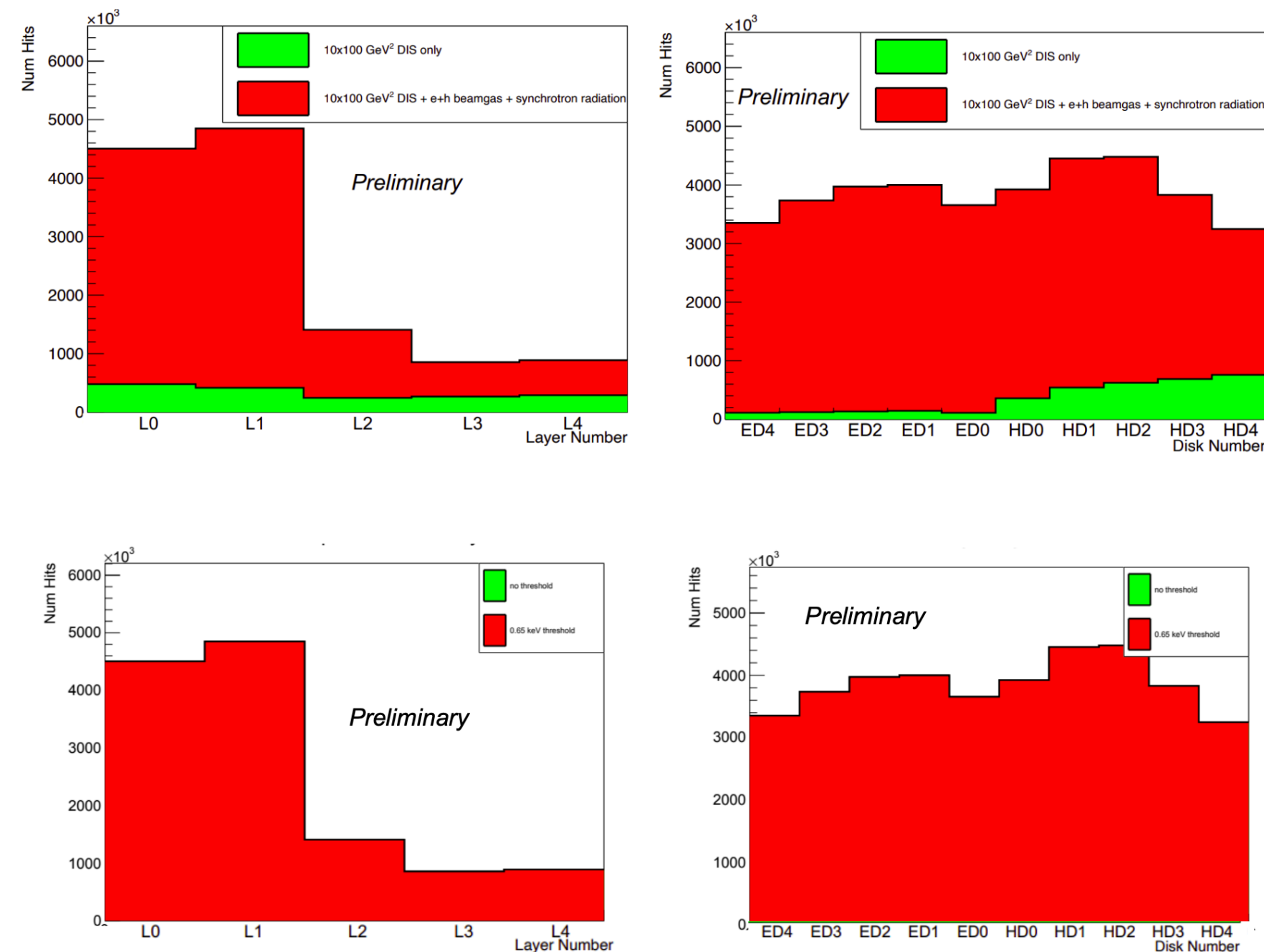

No threshold applied  
Green: DIS only  
Red: DIS + backgrounds

Green: no threshold  
Red: 0.65 keV threshold

## Hit occupancy in the ePIC SVT

- $20.8 \times 22.8 \mu\text{m}^2$  pixel,  $2 \mu\text{s}$  frame rate

	Hz	r (cm)	l (cm)	Area cm2	Hits/s/cm2	Hits/pixel/frame
L0	4.50E+06	3.6	27	610.73	7.38E+03	7.00E-08
L1	4.85E+06	4.8	27	814.30	5.96E+03	5.65E-08
L2	1.41E+06	12	27	2035.75	6.91E+02	6.56E-09
L3	8.55E+05	27	54	9160.88	9.33E+01	8.85E-10
L4	8.89E+05	42	84	22167.08	4.01E+01	3.80E-10

	Hz	r_in (cm)	r_out (cm)	Area cm2	Hits/s/cm2	Hits/pixel/frame
ED0	3.66E+06	3.676	24	1767.11	2.07E+03	1.96E-08
ED1	4.00E+06	3.676	41.5	5368.16	7.45E+02	7.07E-09
ED2	3.97E+06	3.676	42.14	5536.32	7.18E+02	6.81E-09
ED3	3.74E+06	3.848	42.14	5532.26	6.75E+02	6.40E-09
ED4	3.35E+06	4.152	42.14	5524.62	6.07E+02	5.76E-09

	Hz	r_in (cm)	r_out (cm)	Area cm2	Hits/s/cm2	Hits/pixel/frame
HD0	3.92E+06	3.676	24	1767.11	2.22E+03	2.11E-08
HD1	4.45E+06	3.676	41.5	5368.16	8.30E+02	7.87E-09
HD2	4.48E+06	3.786	42.14	5533.75	8.10E+02	7.68E-09
HD3	3.83E+06	4.558	42.14	5513.51	6.95E+02	6.59E-09
HD4	3.25E+06	5.412	42.14	5486.76	5.92E+02	5.62E-09

- Hit rate and hit occupancy in the SVT
  - Estimated for 10 GeV x 100 GeV DIS ep events plus beam gas backgrounds and SR
  - Cluster size and fake hit rate not included
  - Hit rate in the SVT dominated by background hits
  - 3-5 MHz in IB and endcaps,  $\leq 1$  MHz in OB
  - Low hit occupancy per pixel per  $2 \mu\text{s}$  frame rate



# SVT Workfest: Sensor

Iain Sedgwick (RAL)

## Background - MOSAIX

### ITS3 Chip development

- CERN currently developing a new chip for the ITS3 upgrade of ALICE – MOSAIX
- Will be “wafer scale” – full length, one reticle wide
- Idea is to thin and bend them around the beampipe. Dicing to different width will give the three required layers.

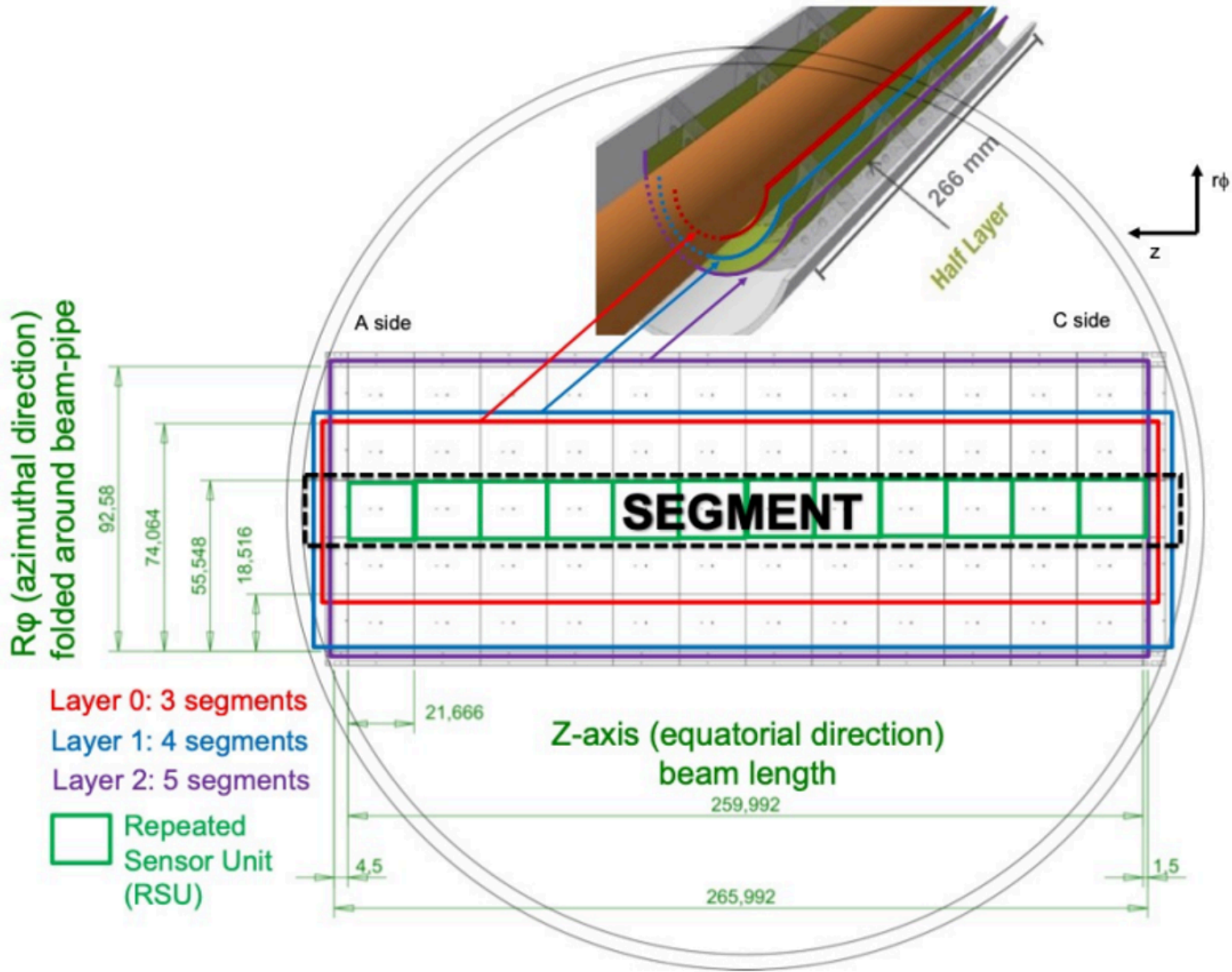

# SVT Workfest: Sensor

Iain Sedgwick (RAL)

## Background - MOSAIX

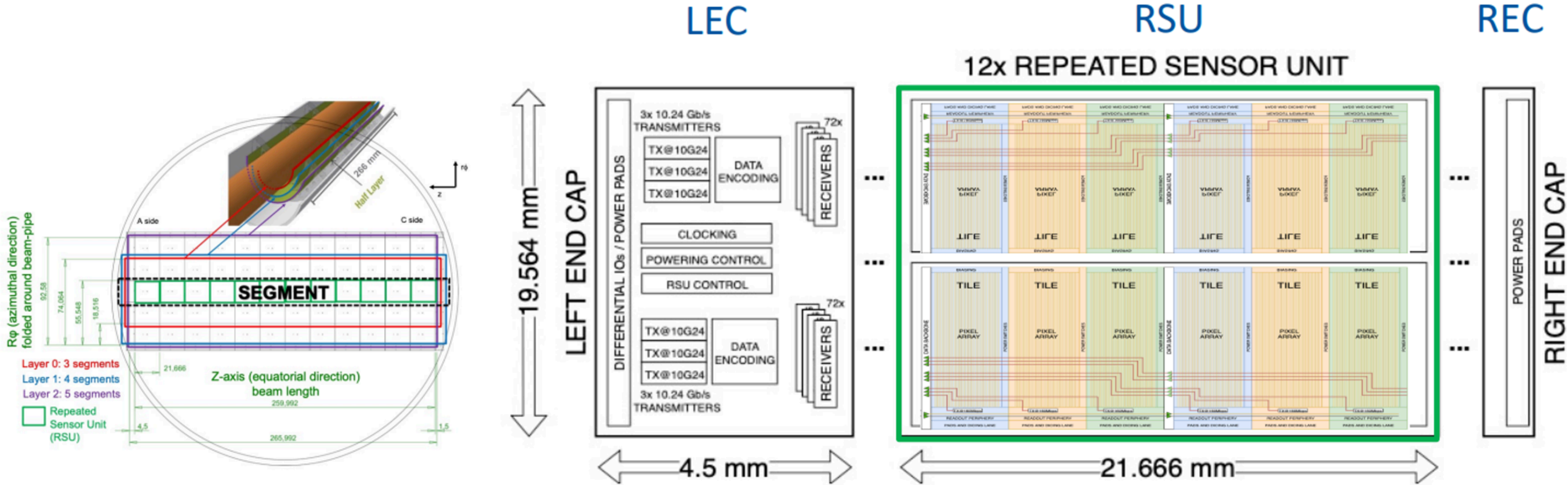

Figure 3.34: Block diagram of the sensor segment.



# SVT Workfest: Sensor

Iain Sedgwick (RAL)

## ITS3 to ePIC

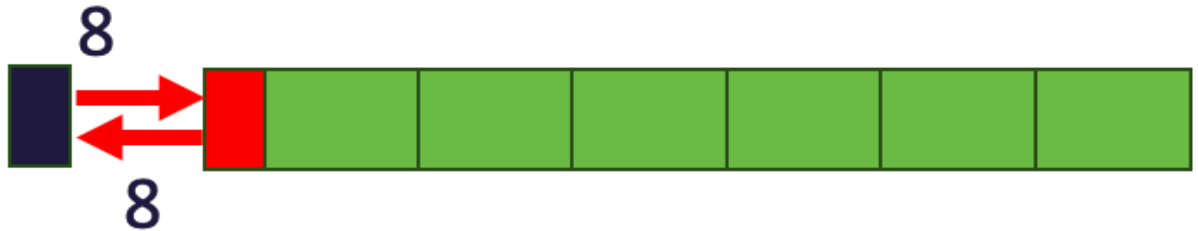

### Inner Barrel

- Use MOSAIX directly
- Requires supply agreement with CERN (in negotiation)
- Planning difficult since design in flux – need to account for this

**Inner Barrel (IB)**  
3 curved layers

**Outer Barrel (OB)**  
2 stave-based layers

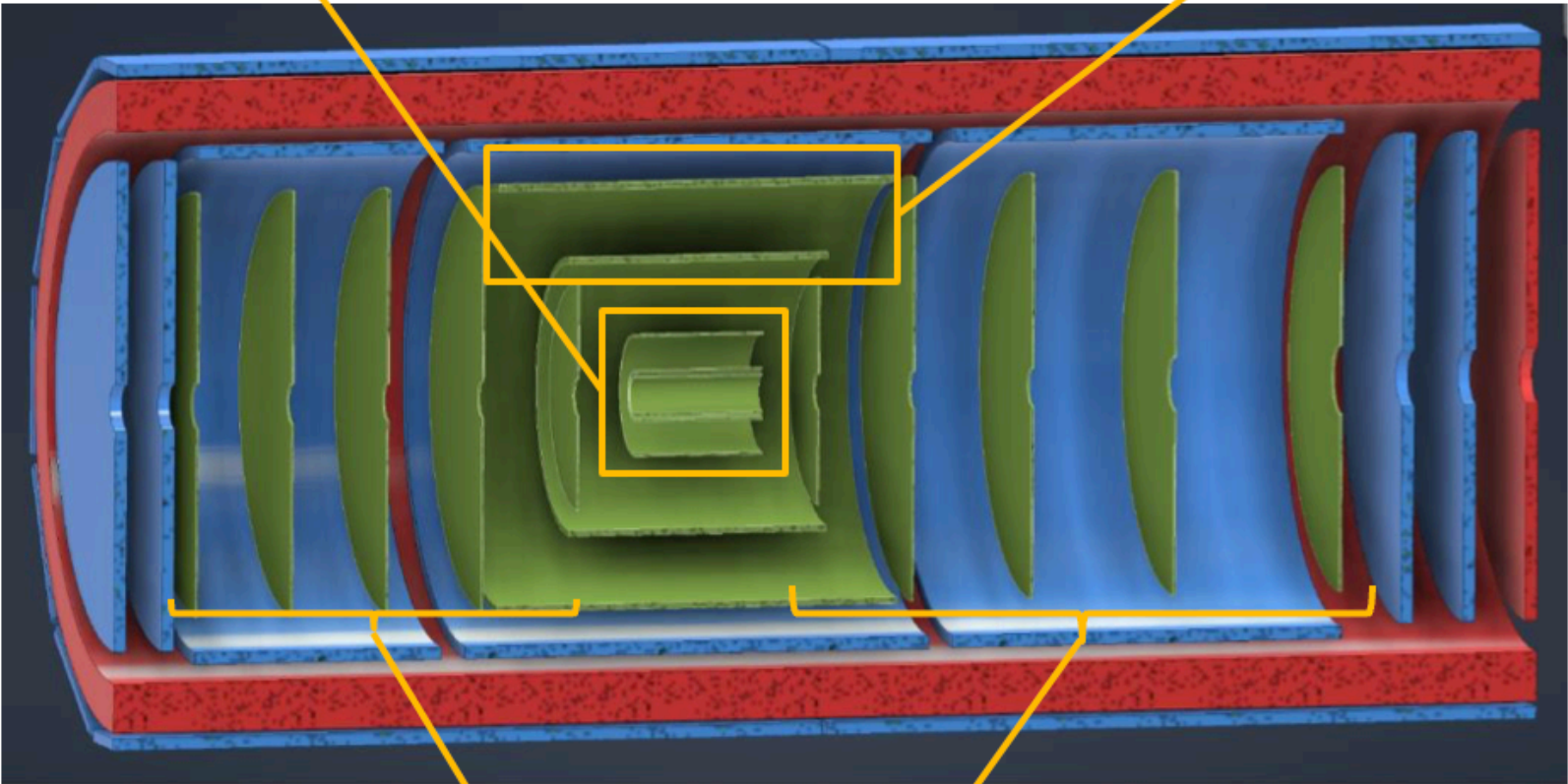

### Outer Barrel/Discs

- Improve Yield – reduce number of RSUs
- Need to reduce mass at system level
- Requires agreement for database access with CERN (in negotiation)

*Develop an EIC-LAS plus support chip for staves and discs*

*Keep up to date with MOSAIC developments (TDR next major release)*

# SVT Workfest: Sensor

Iain Sedgwick (RAL)

## MOSAIX to EIC-LAS



### Inner Barrel

- 12 RSUs
- 8 data links
- 7 slow control links
- Direct powering

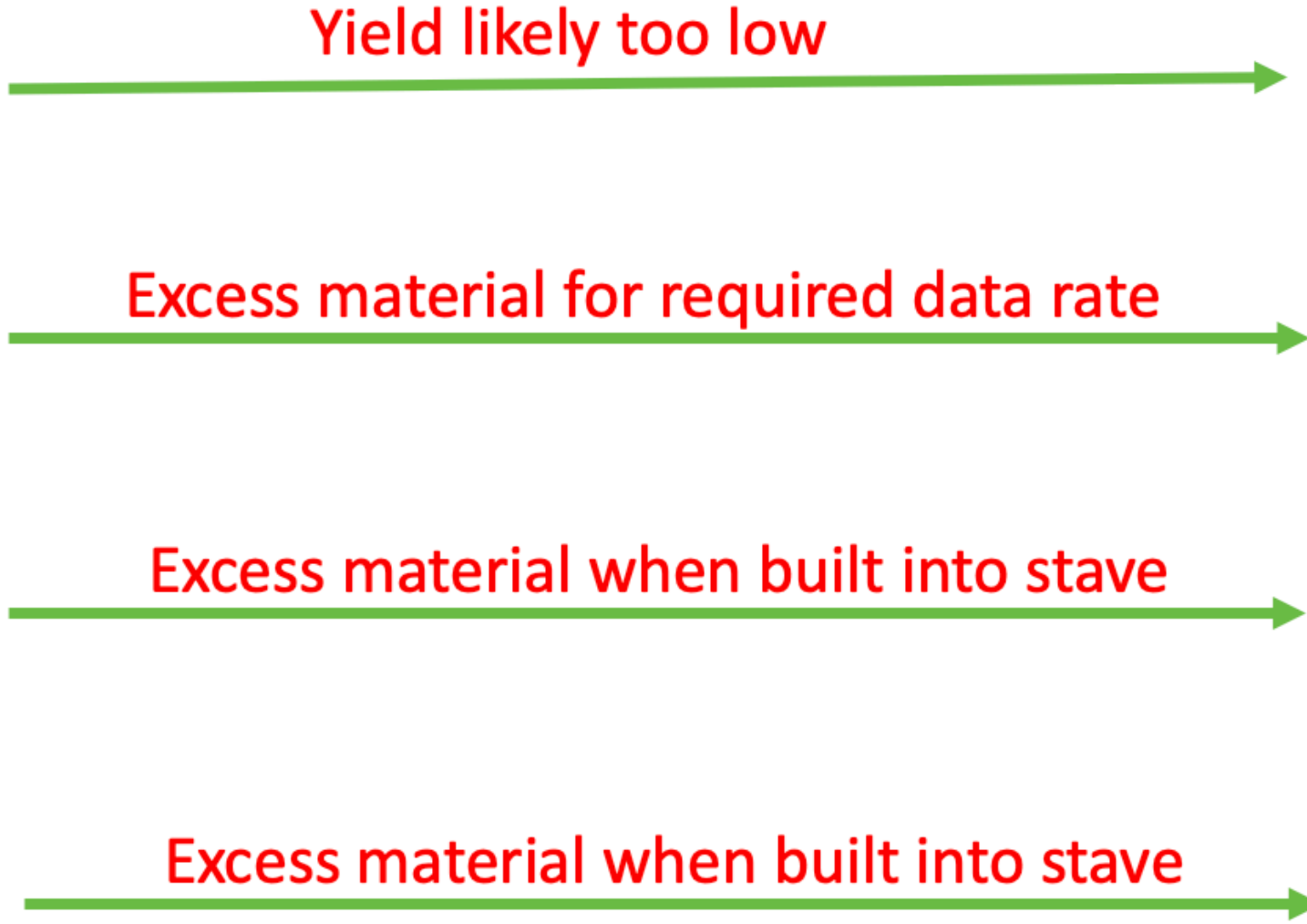

### Outer Barrel

- Reduced number of RSUs
- Single data link
- Multiplex slow control
- Serial powering

Must be done on 65nm MOSAIX database

Could be on support chip

# SVT Workfest: Sensor

Iain Sedgwick (RAL)

## MOSAIX to EIC-LAS



### Inner Barrel

- 12 RSUs
- 8 data links
- 7 slow control links
- Direct powering

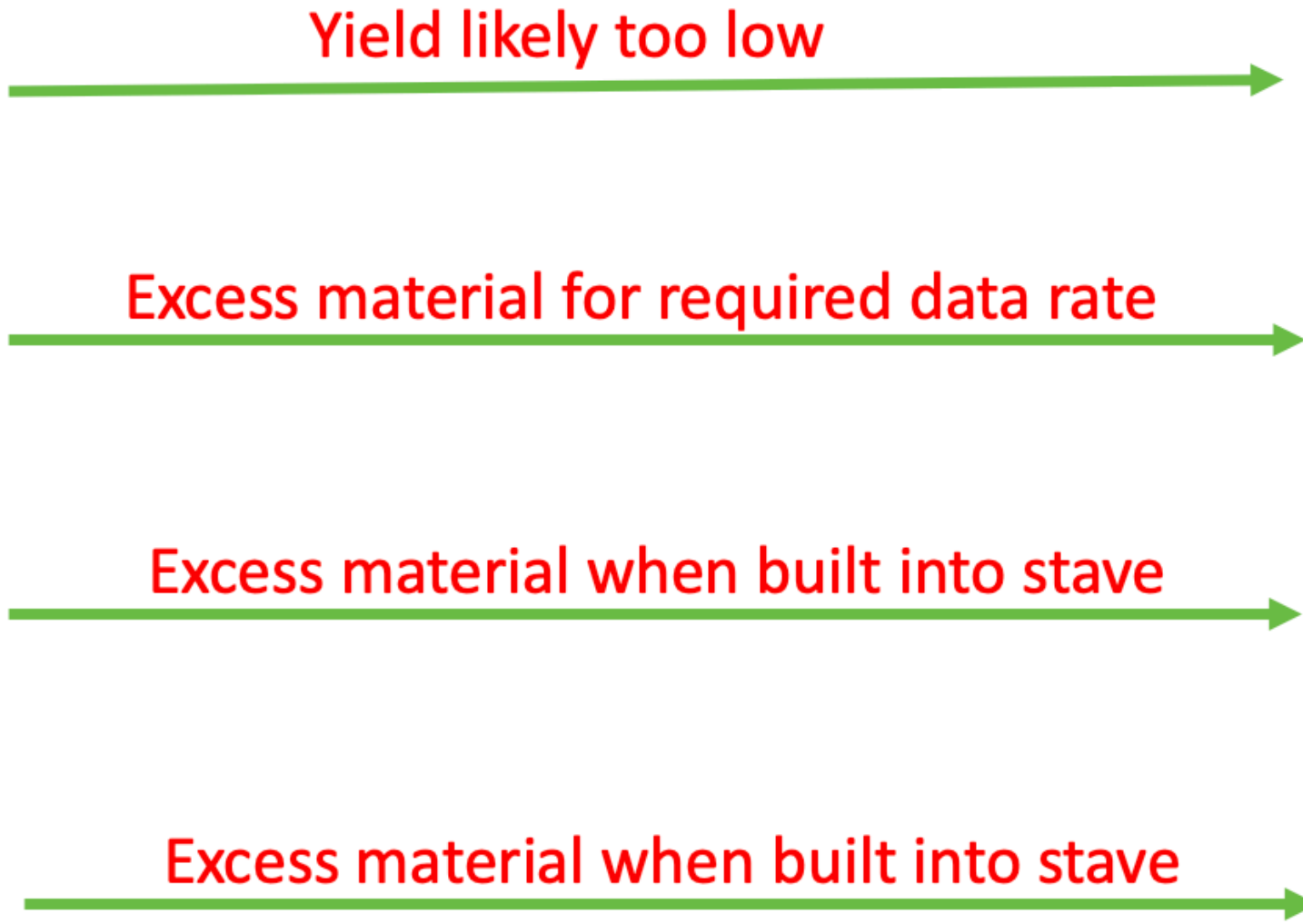

### Outer Barrel

- Reduced number of RSUs
- Single data link
- Multiplex slow control
- Serial powering

Must be done on 65nm MOSAIX database

Could be on support chip



# SVT Workfest: Sensor

Grzegorz Deptuch (BNL)

## Design for ePIC SVT (1)

### MAPS Sensors

- Contribution to ALICE ITS3 MAPS, aiming at application for inner layers
  - MOSAIX (ER2) sensors that is derivative of MOSS/MOST sensors fabricated in ER1, follow choices of CERN (architecture, links, speed, fill factor)
- Developing EIC-oriented MAPS basing on full or partial database of ALICE ITS3 MAPS for outer layers and disks
  - optimize stitching lengths, data transmission bandwidths

### Auxiliary Circuits

Handle implications of serial powering in ePIC SVT (v.s. parallel powering in ALICE ITS3) for data, power and bias resources

- Developing power and slow control management ASIC, performing combined (preferred) functions of
  - ShuntLDO (LDO),
  - generator of negative sensors bias,
  - slow control bidirectional distributor to multiple stitched MAPS (compatible with lpGBT interface)
- Selection of fabrication process
  - TPSCo 65 homogenous but limited to ~3.3V max voltage;
  - High Voltage, such as XH018, heterogenous but no practical limit on negative sensor bias (radiation characterization may be needed)

# SVT Workfest: Sensor

Grzegorz Deptuch (BNL)

## Design for ePIC SVT (1)

### MAPS Sensors

- Contribution to ALICE ITS3 MAPS, aiming at application for inner layers
  - MOSAIX (ER2) sensors that is derivative of MOSS/MOST sensors fabricated in ER1, follow choices of CERN (architecture, links, speed, fill factor)
- Developing EIC-oriented MAPS basing on full or partial database of ALICE ITS3 MAPS for outer layers and disks
  - optimize stitching lengths, data transmission bandwidths

### Auxiliary Circuits

Handle implications of serial powering in ePIC SVT (v.s. parallel powering in ALICE ITS3) for data, power and bias resources

- Developing power and slow control management ASIC, performing combined (preferred) functions of
  - ShuntLDO (LDO),
  - generator of negative sensors bias,
  - slow control bidirectional distributor to multiple stitched MAPS (compatible with lpGBT interface)
- Selection of fabrication process
  - TPSCo 65 homogenous but limited to ~3.3V max voltage;
  - High Voltage, such as XH018, heterogenous but no practical limit on negative sensor bias (radiation characterization may be needed)

# SVT Workfest: Readout

Jo Schambach (ORNL)

## Off Detector Electronics – Simplified Overview

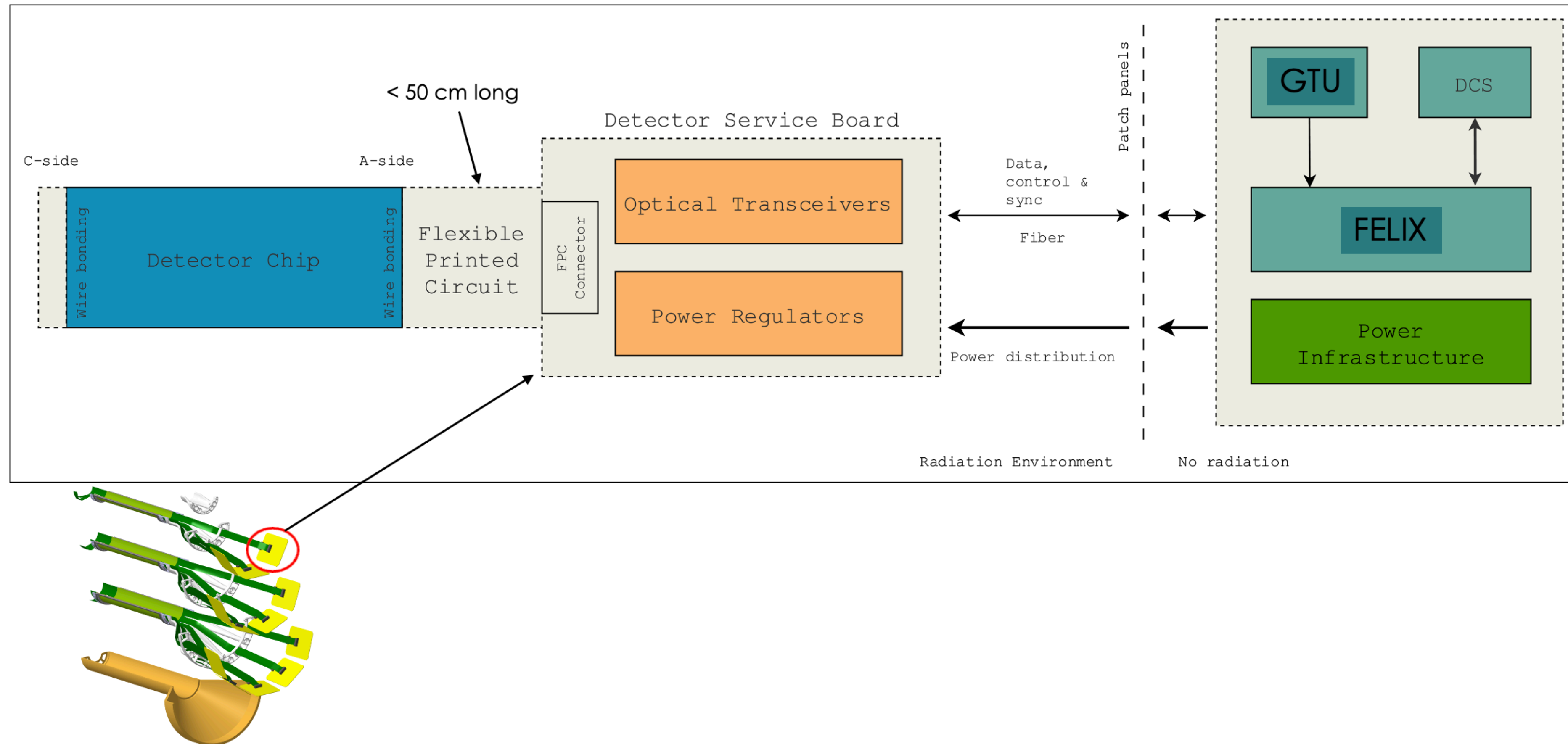



# SVT Workfest: Readout

Jo Schambach (ORNL)

## SVT Readout (inspired by ITS3 Readout)

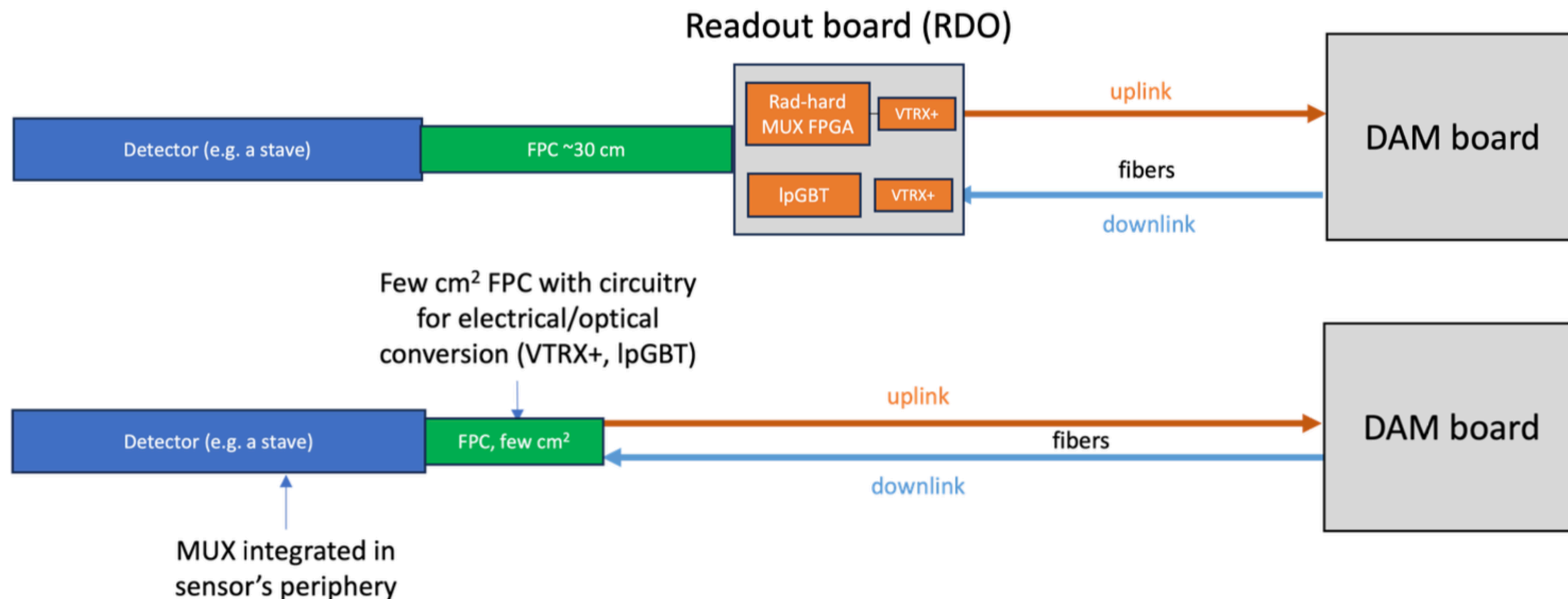

# SVT Workfest: Readout

Jo Schambach (ORNL)

## Open Issues

- Chip Control Redundancy, (similar to data path redundancy), e.g.:

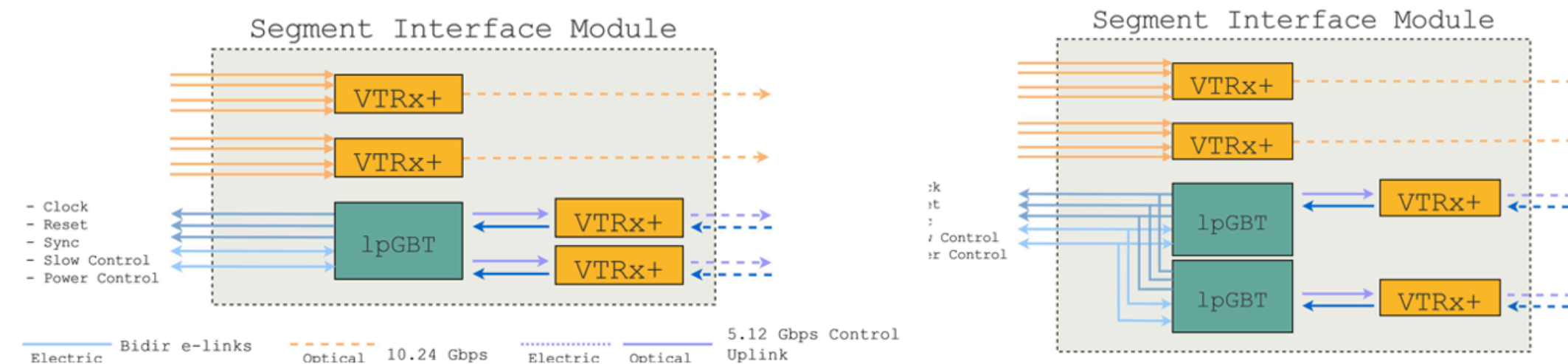

- Location of VTRx+ and Control Board (SC, power) for both Barrel and Discs
- Data Aggregation before FELIX: 4134 readout links need 87 FELIXs, but total data rate only ~29 Gbps. Each link can carry 7.68 Gbps (10.24 Gbps, lpGBT, FEC12)
- Noise Rate? TDR specifies  $0.1 \text{ pixel}^{-1}\text{s}^{-1}$ , i.e. 1.6 Gpixel per sec.
- Alternatives to lpGBT: PolarFire multiplexing, Samtec optical FireFly (at least in Discs, where radiation load is not so high)

# SVT Workfest: Power

Laura Gonella (Birmingham)

## Serial powering basics

- As the modules are powered with a constant current,  $V_{\text{drop}}$  is not constrained as in a voltage based powering scheme.
  - It can in principle be chosen only depending on the output voltage capability of the current source and of the allowed power density (i.e. cooling capability).
- Higher  $V_{\text{drop}}$  can be allowed in the active area of the detector to reduce the material budget of the cables.
  - Outside the detector the voltage drop can be reduced to lower the power losses.
- With respect to voltage based powering schemes (incl. DC-DC), serial powering allows more flexibility in the optimization of material and power efficiency.

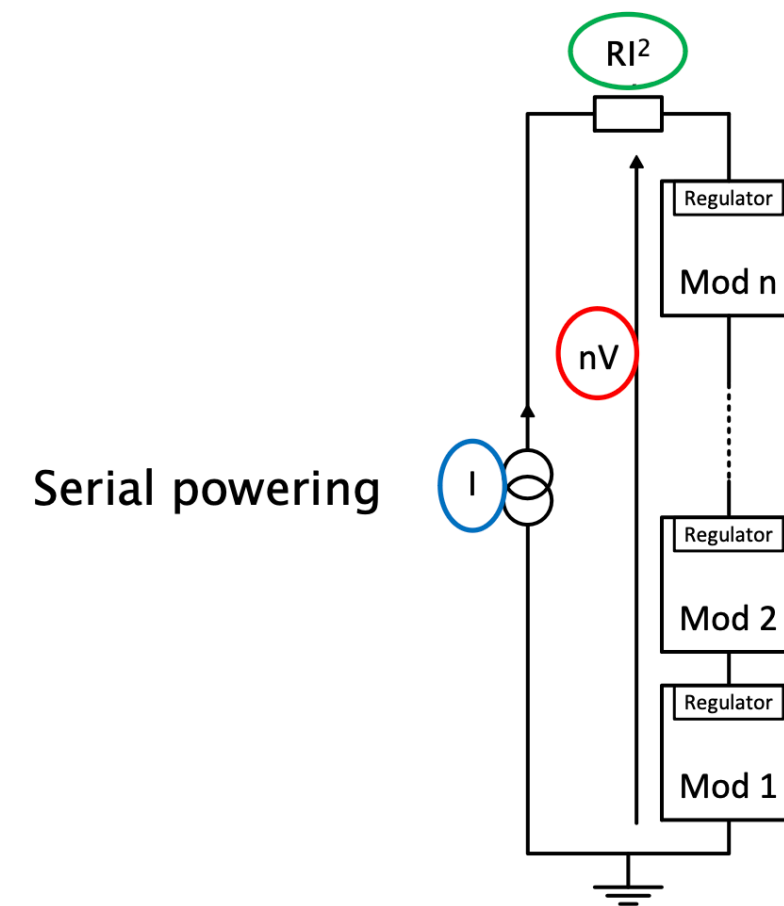
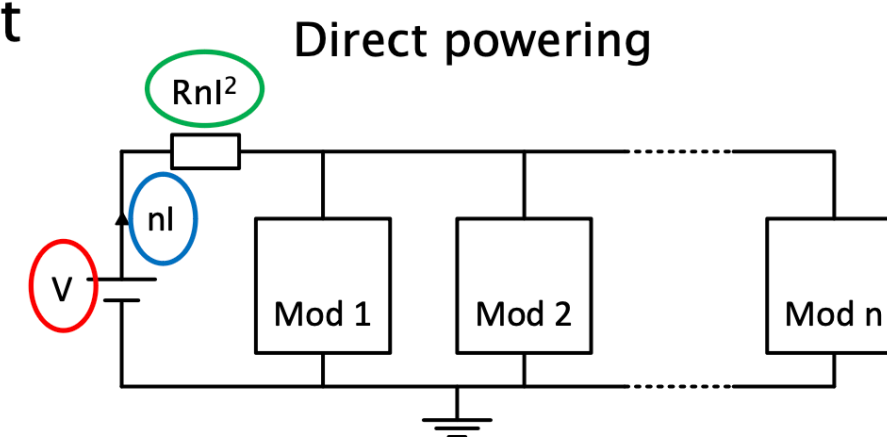

## Serial powering basics: data transmission

- The voltage across the chain is  $nV$ , where  $V$  is the voltage on a module.
- Each module sits at a different ground potential.
- AC coupled data transmission required.
  - DC balanced data protocol (e.g. 8b10b).
  - Self biased receiver inputs to set the common mode voltage.

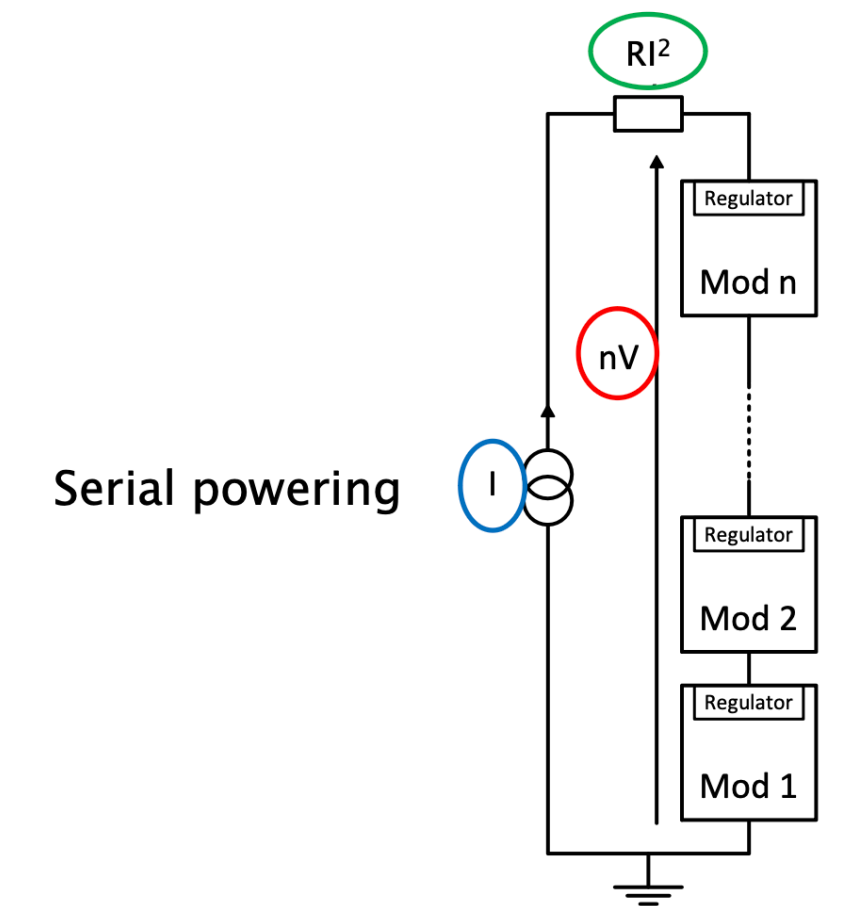
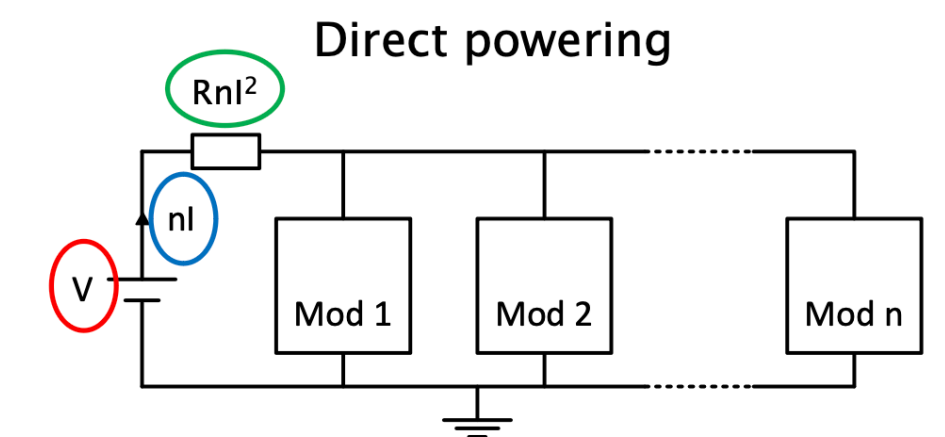

Sketch of a AC-coupled LVDS link

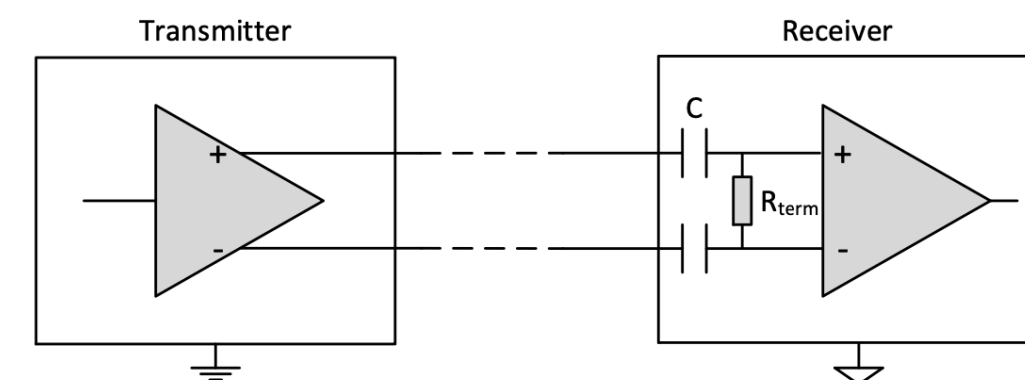



# SVT Workfest: Power

James Glover (Birmingham)

## ITS3 ER2 expected power domains

### Power Domains and Currents

Supply purpose	Nets	Voltage [V]	Current [mA]	Pads on LEC	Pads on REC
Services	SDVDD-SDVSS	1.2 to 1.32	227	Yes	Yes
Global analog	GAVDD-GAVSS	1.2 to 1.32	540	Yes	Yes
Global digital	GDVDD-GDVSS	1.2 to 1.32	1369	Yes	Yes
Serializers	TXVDD-TXVSS	1.8	200	Yes	No
Substrate bias	PSUB	-1.2 to 0			

**Table 3.11:** Power domains of one sensor segment. The substrate bias is common to all the segments composing a sensor. The nominal operating voltage are referred to the potential of the GAVSS input net. The input currents are obtained assuming the maximum estimated power consumption of the LEC and RSU circuits at 25 °C.

From: 20<sup>th</sup> Nov '23, EP R&D WP 1.2 – G. Rinella, “Design of MOSAIX - ER2 Stitched Sensor Prototype”,  
<https://indico.cern.ch/event/1339888/contributions/5680443/attachments/2755393/4797584/20231120-ER2-Stitched-Sensor.pdf>

20231120 | WP1.2 Plenary | ER2 Stitched Sensor Design

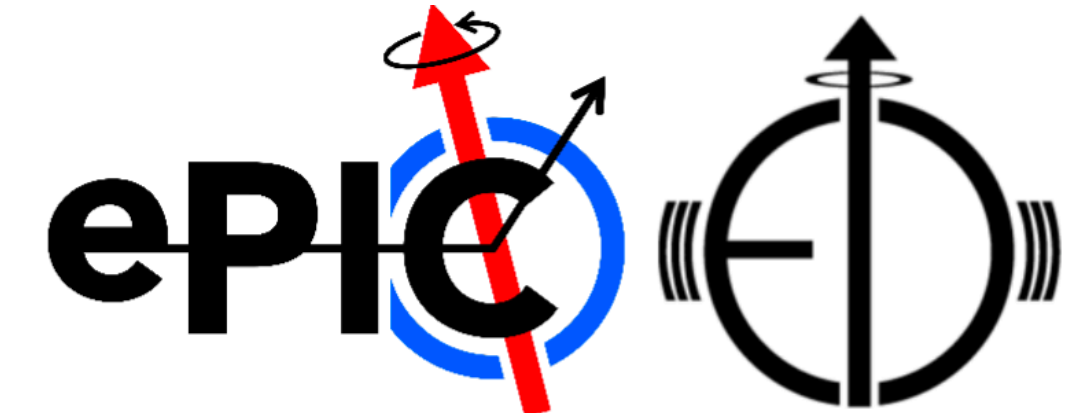

- 3 domains all around +1.2 V.
  - Services
  - Global analog
  - Global digital
- 1 Serializers domain at +1.8 V.
- 1 Substrate bias domain at -1.2 V.

# SVT Workfest: Power

James Glover (Birmingham)

## S-LDO config per EIC-LAS

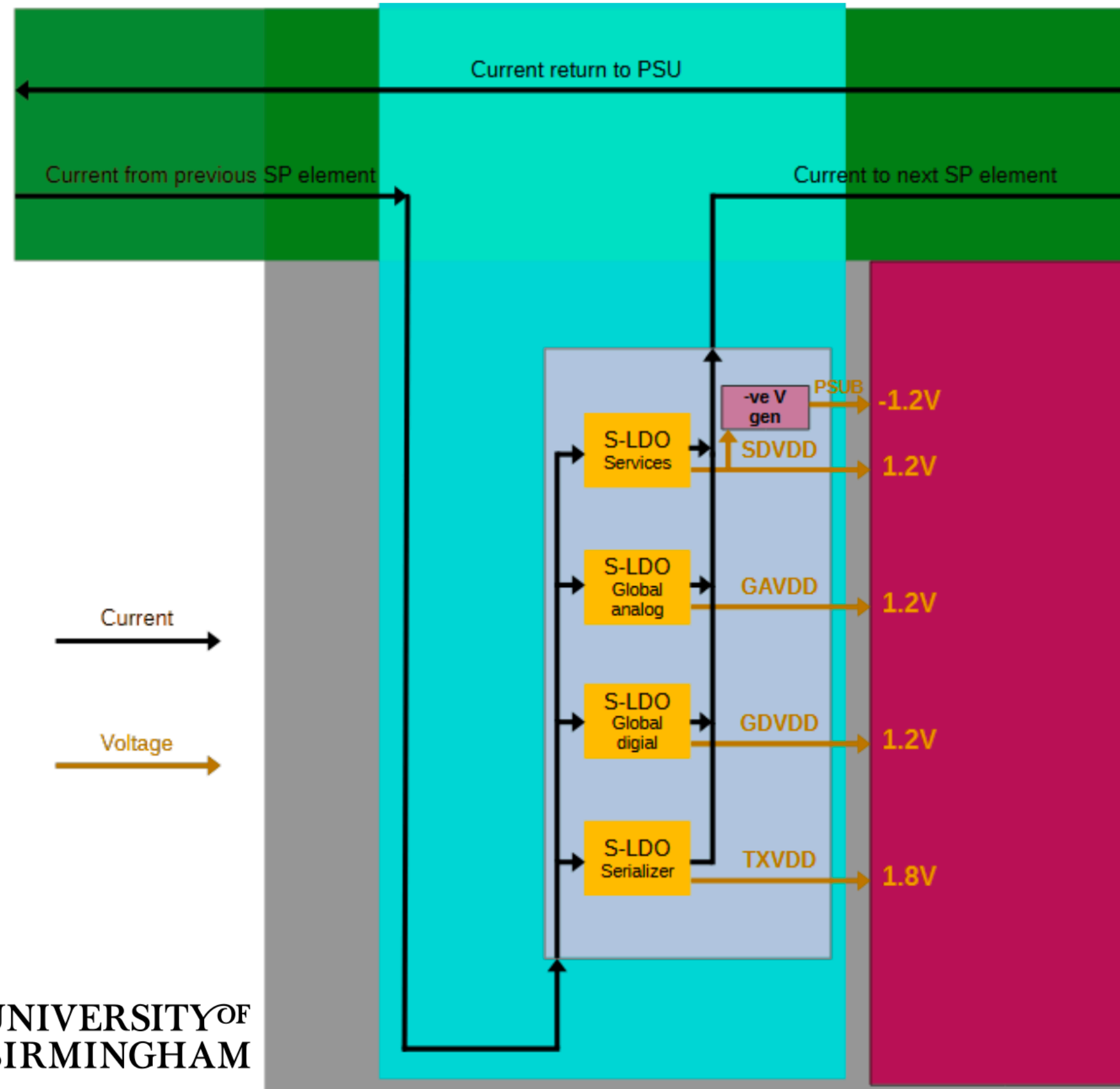
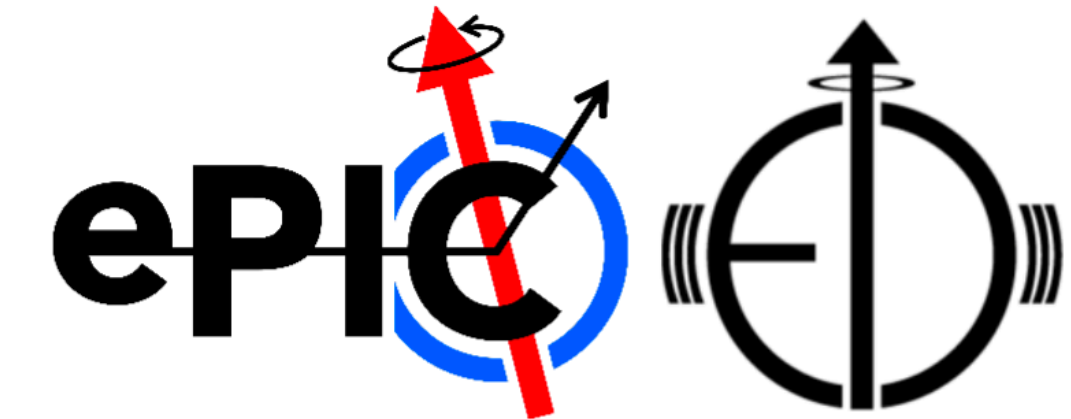

- Basic configuration overview (no redundancy shown).
- Negative voltage generator could run from any of the 4 S-LDO domain voltages.
  - Just shown on **Services** as this is lowest power.

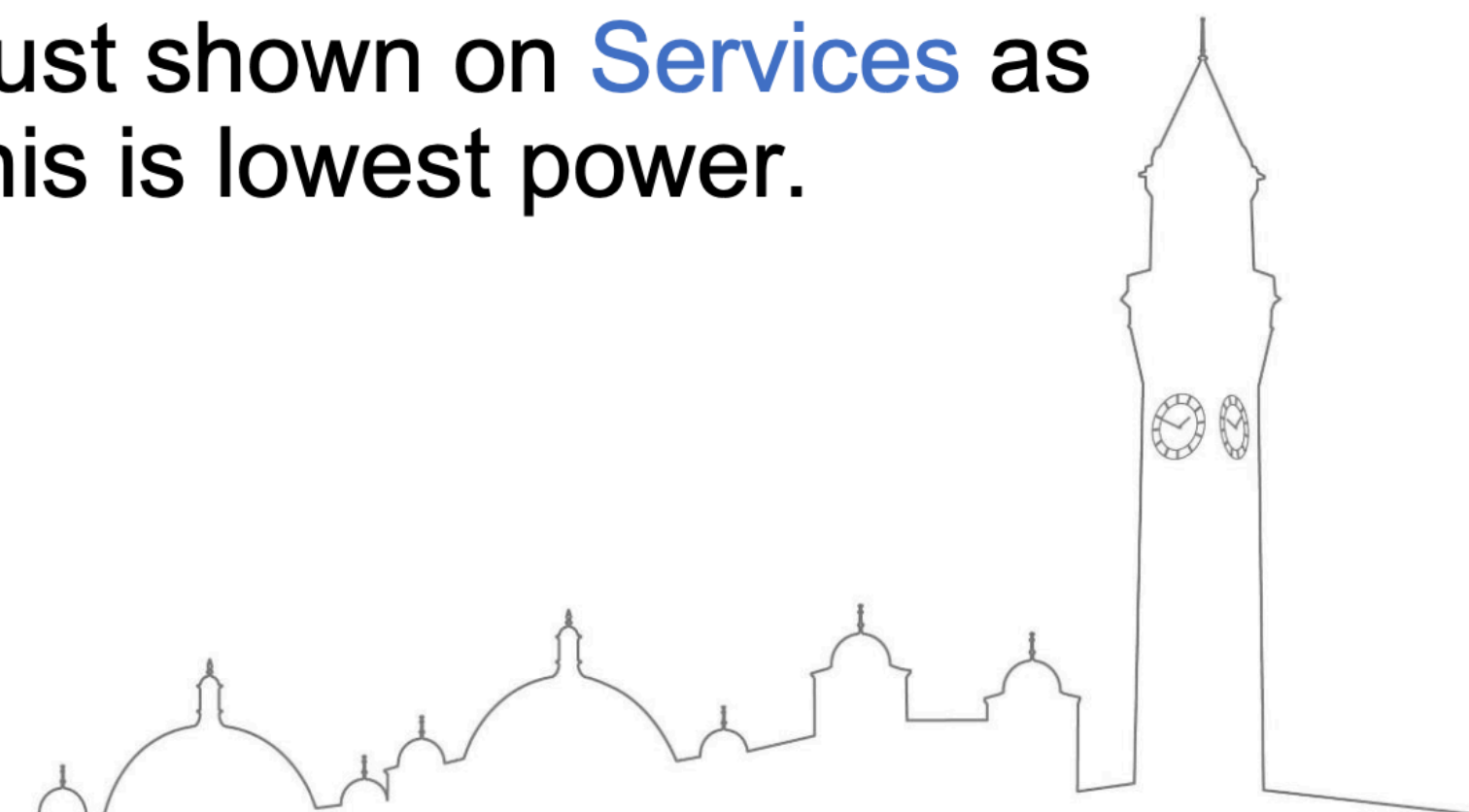



# SVT Workfest: Sensor Characterization

Lukas Tomasek (CTU, Prague)

## First in-beam characterization of MOSS

### Goals:

- efficiency and spacial resolution characterization for different sensor regions
- Scan of the sensor performance in different voltage conditions

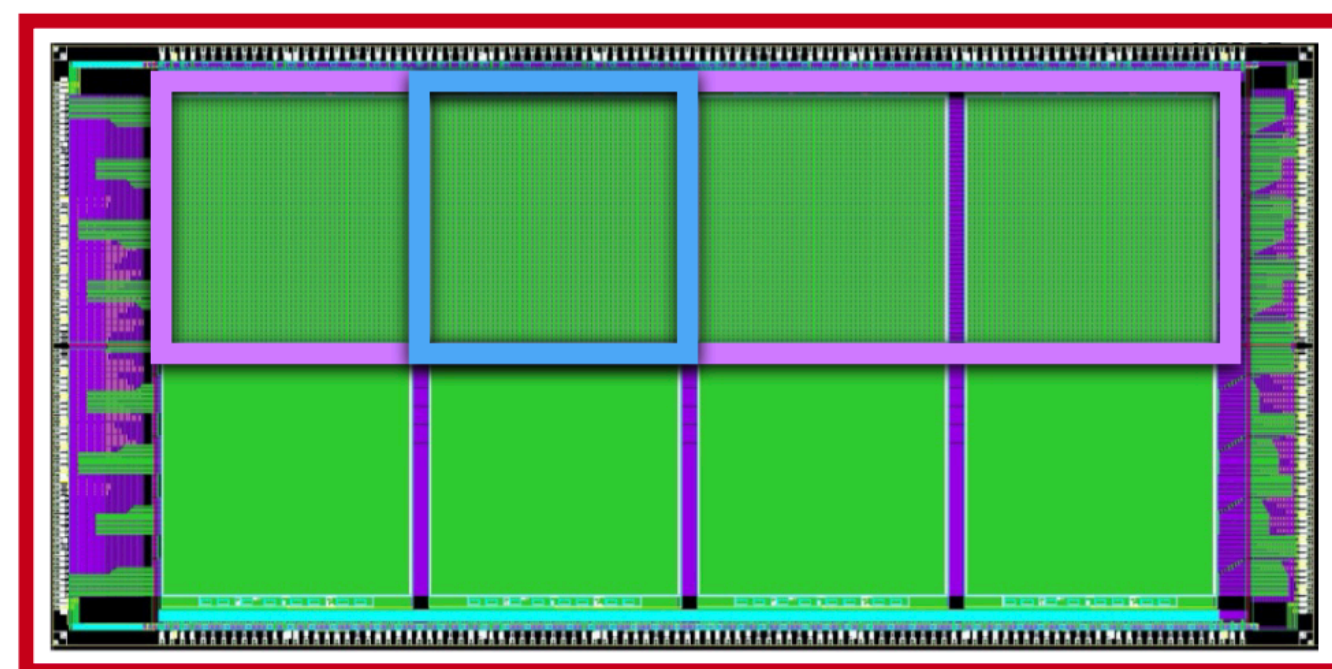

Top:  
256 x 256 pixels  
Pitch: 22.5  $\mu\text{m}$

Bottom:  
320 x 320 pixels  
Pitch: 18  $\mu\text{m}$

25.9 cm

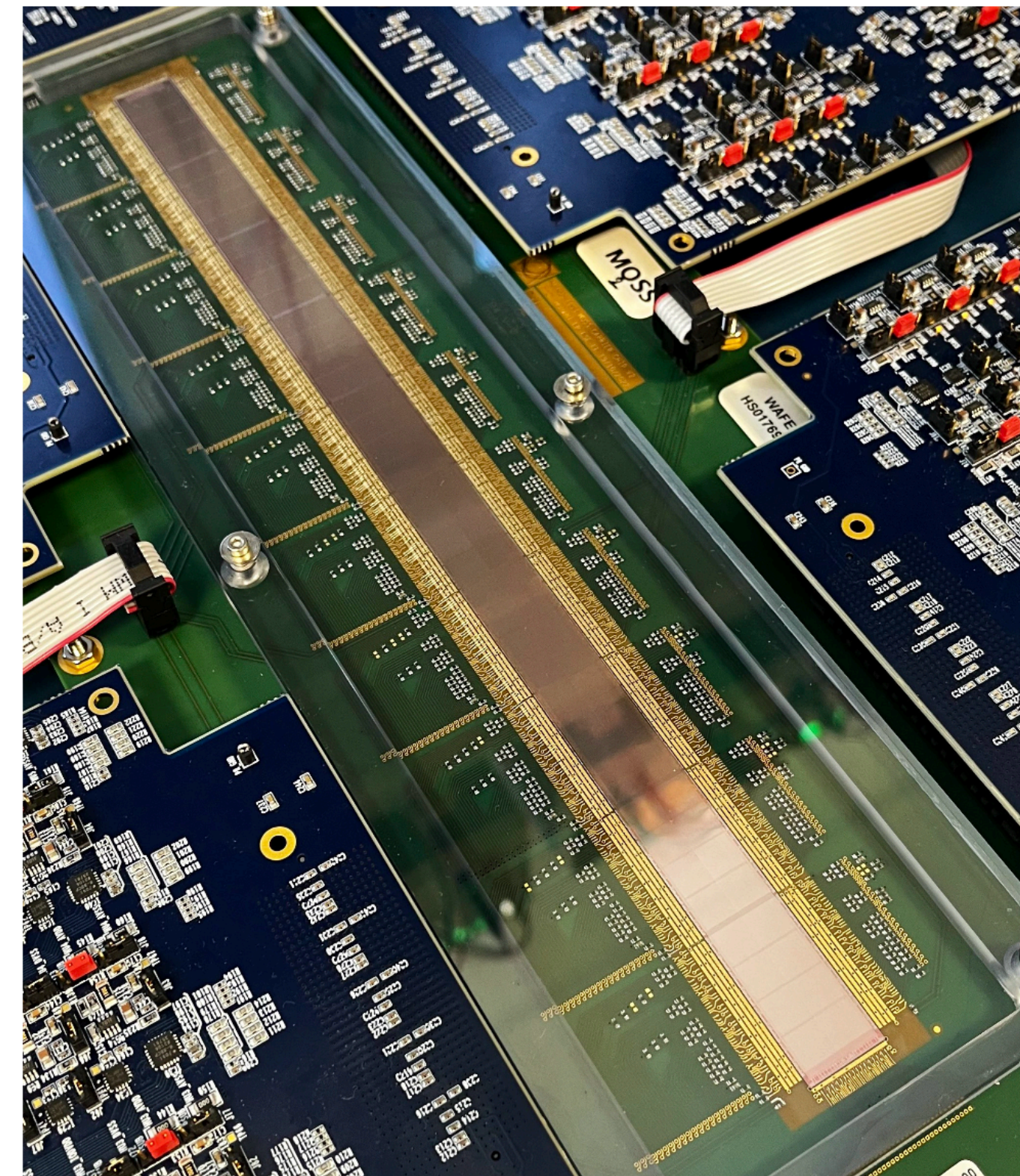
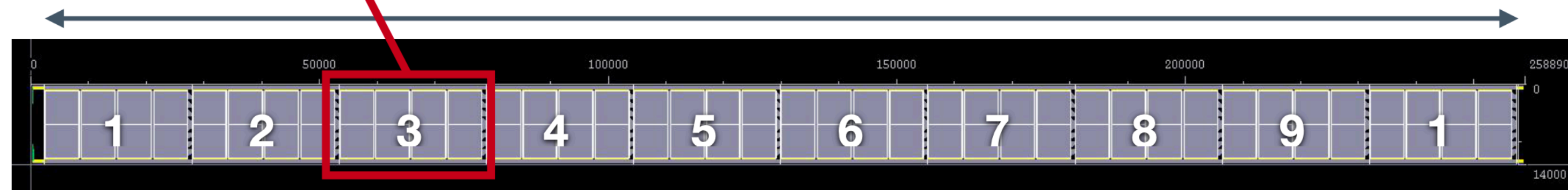



# SVT Workfest: Sensor Characterization

Lukas Tomasek (CTU, Prague)

## MOSS test beams at PS at CERN

- Optimization the data-taking software for data acquisition to operate with the MOSS sensor
- Installation/setup of the telescope at PS
- Optimization of the Corryvreckan analysis framework
- First characterization of efficiency and resolution:  
(updated versions of these results will be included in the ITS3 TDR)

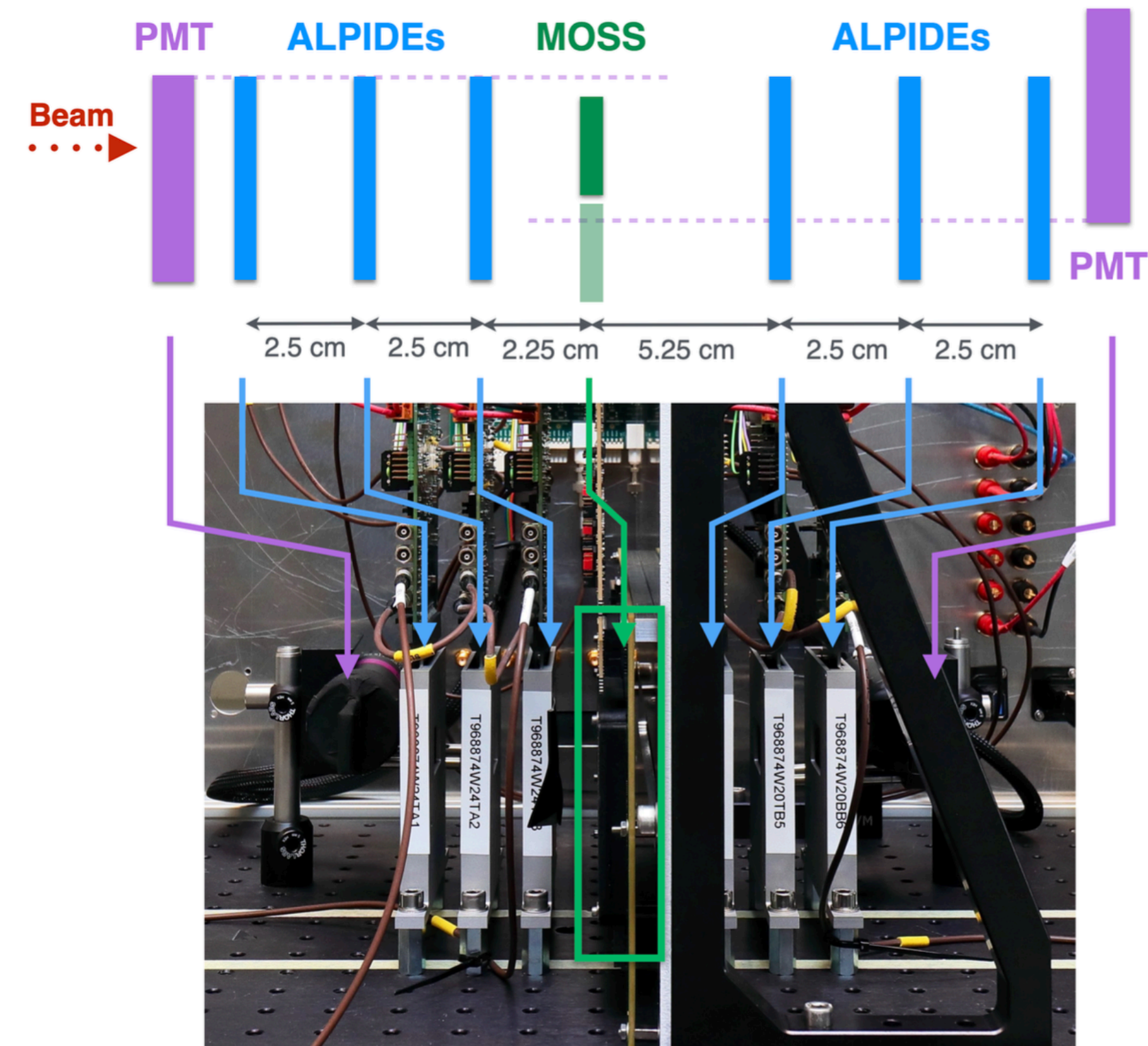
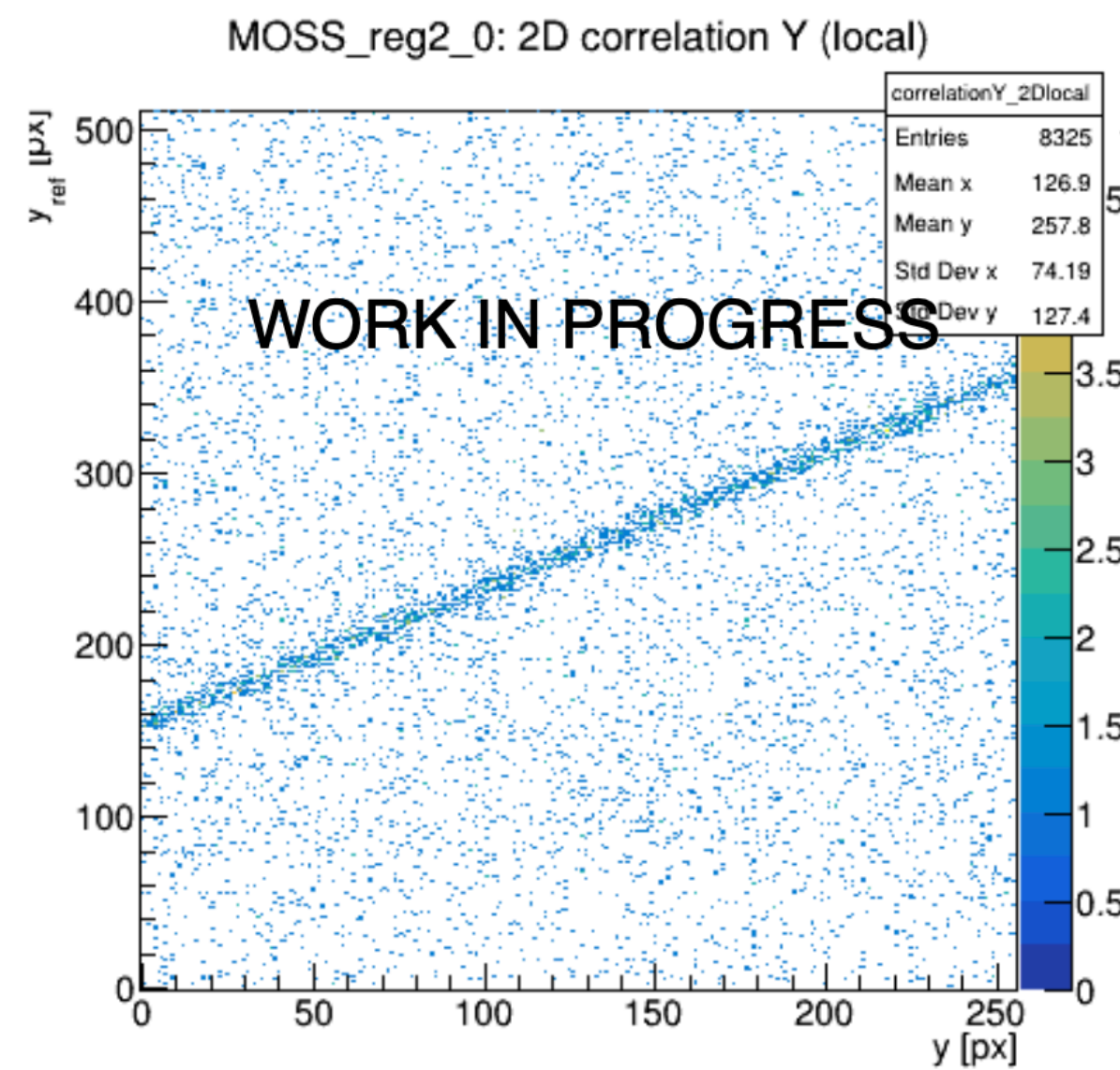



# SVT Workfest: Sensor Characterization

Lukas Tomasek (CTU, Prague)

## Overview of past SVT contributions to ITS3 effort

### ◆MIT

- participated to the first test beams of the ER1 MOSS sensor to extract efficiency and space resolution.



### ◆LBNL and UC Berkeley

- contributed 20 assembled DAQ boards to ITS3 for sensor characterization to help overcome supply-chain shortages;
- contributed to ITS3 MLR1 sensor DPTS characterization and test beam data taking and analysis, multiple studies including ToT;



### ◆INFN

- testing/optimization of the MLR structures for EIC specific applications, define the configuration settings that minimize integration time and noise hit level;
- contribution to the development of DAQ system and test the ER1 stitched sensor yield.

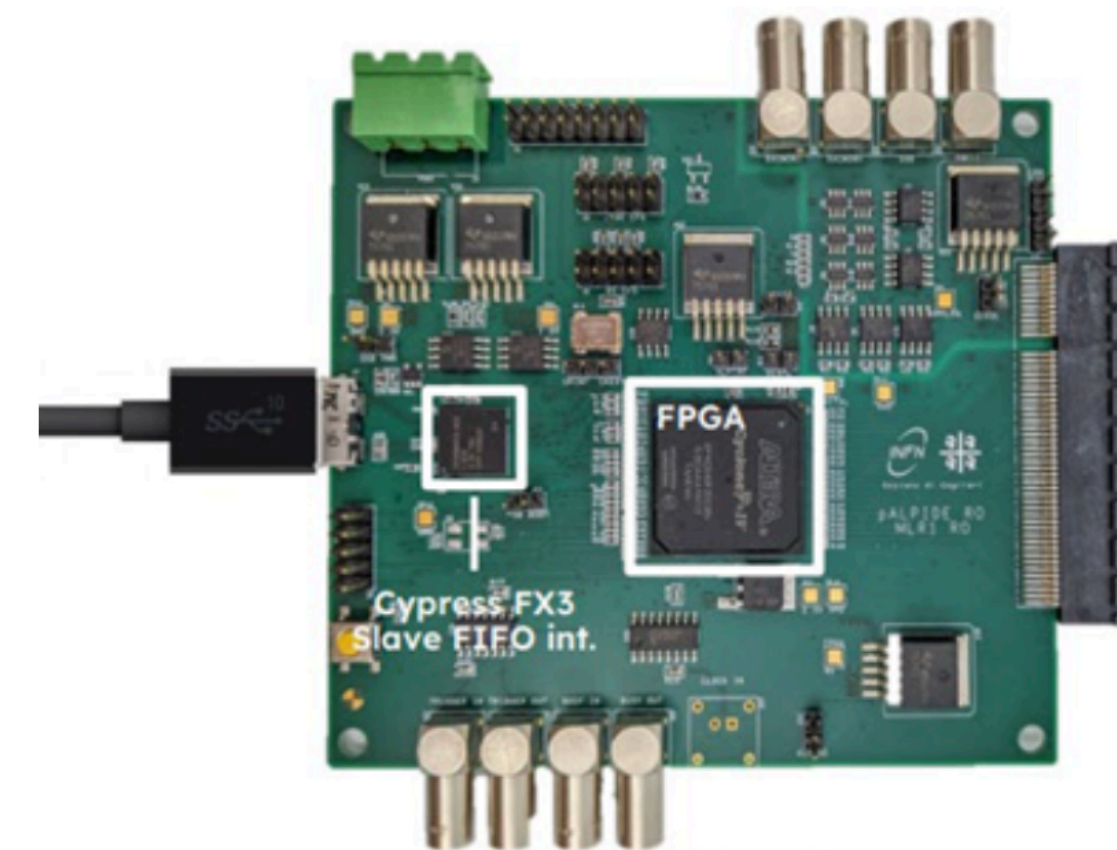

DAQ Board





# SVT Workfest: Sensor Characterization

Lukas Tomasek (CTU, Prague)

## Overview of past SVT contributions to ITS3 effort

### ◆ LANL

- 8 ALPIDE stave telescope has been setup at LANL, which will be used to characterize the ER1, ER2 and potentially EIC LAS sensors.



### ◆ ORNL

- characterization of the ITS3 MLR1 DPTS sensor via calibration of the pixels with radioactive sources and X ray fluorescence,
- CML buffer parameter scan, time-over-threshold studies, pixel-per-pixel variations



### ◆ UK groups

- full characterization of the MLR1 circuits blocks commissioned by RAL;
- involved in testing of APTS and DPTS



- participation on ITS3 MLR1 and ER1 CE65 test structures characterisation with Fe55 source and X-ray fluorescence.



New groups to join testing activities are very welcome!

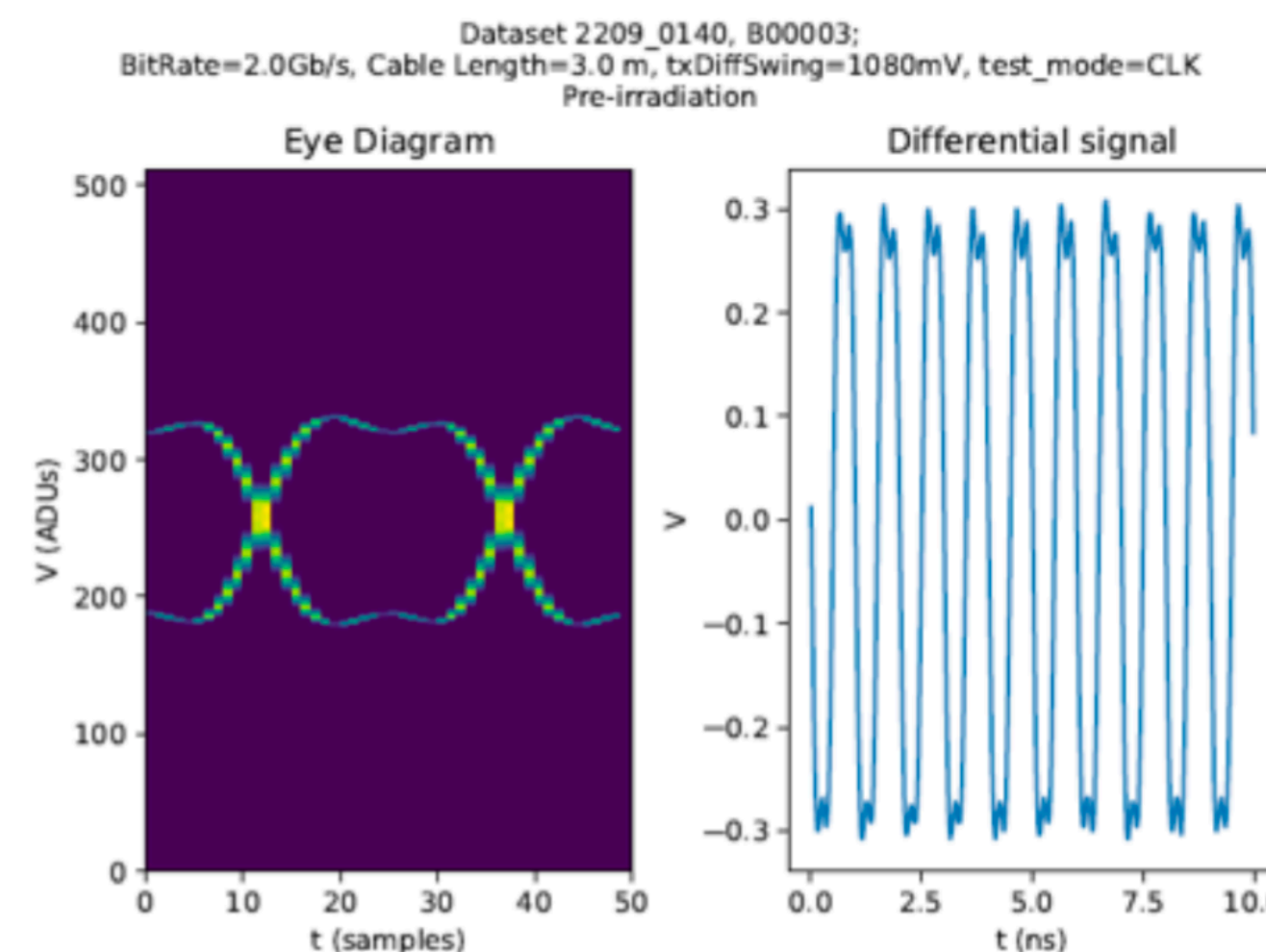
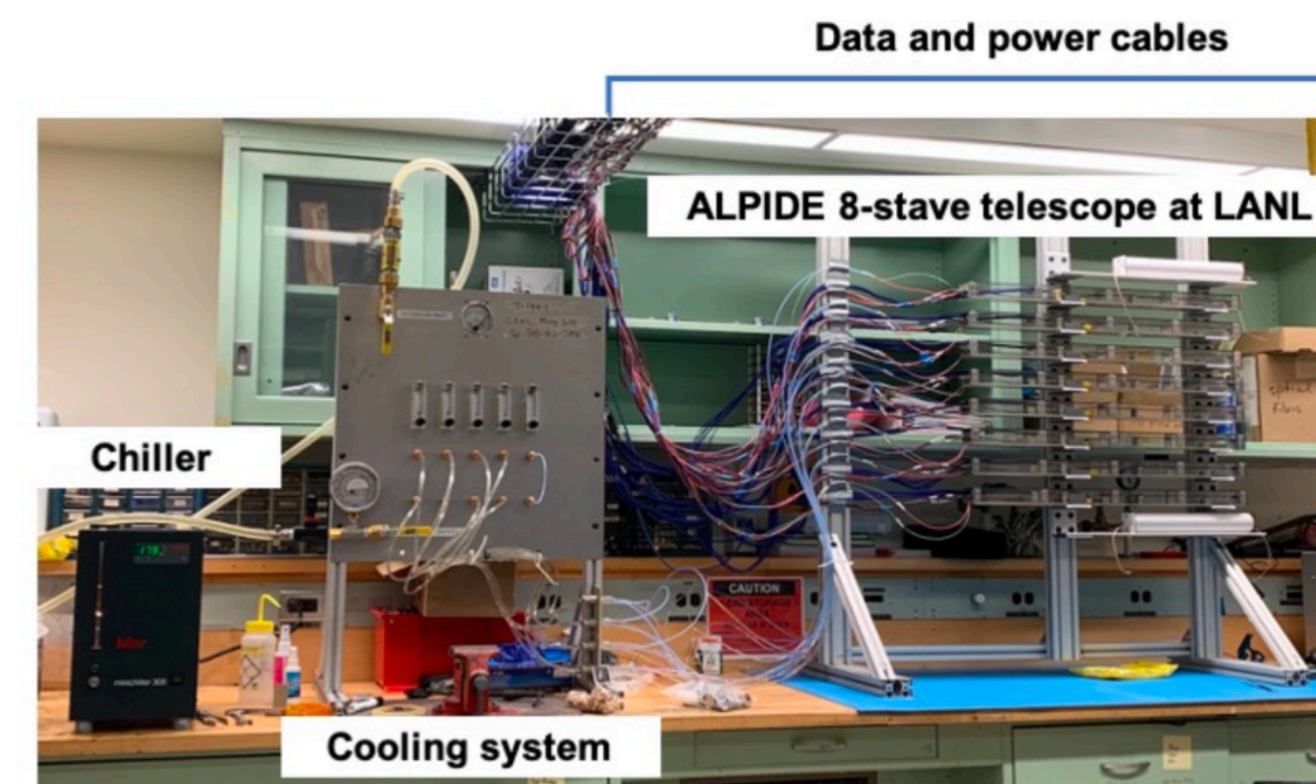



# SVT Workfest: Cooling

Nicole Apadula (LBNL)

## Power Density

From EP R&D WP 1.2 General Reporting Meeting



	Power density [mW cm <sup>-2</sup> ]		
	Expected 25 °C	Max 25 °C	Max 45 °C
Left End Cap (LEC)		791	
Active area (RSU)	28	44	
Pixel matrix	15	32	51
Biasing	168	168	168
Readout peripheries	432	457	496
Data backbone	719	719	719

LEC (aka periphery) ~0.8 W/cm<sup>2</sup>  
Matrix (total) ~20-40 mW/cm<sup>2</sup>

Table 3.10: Estimates of average power dissipation per unit area over the main blocks composing the sensor.

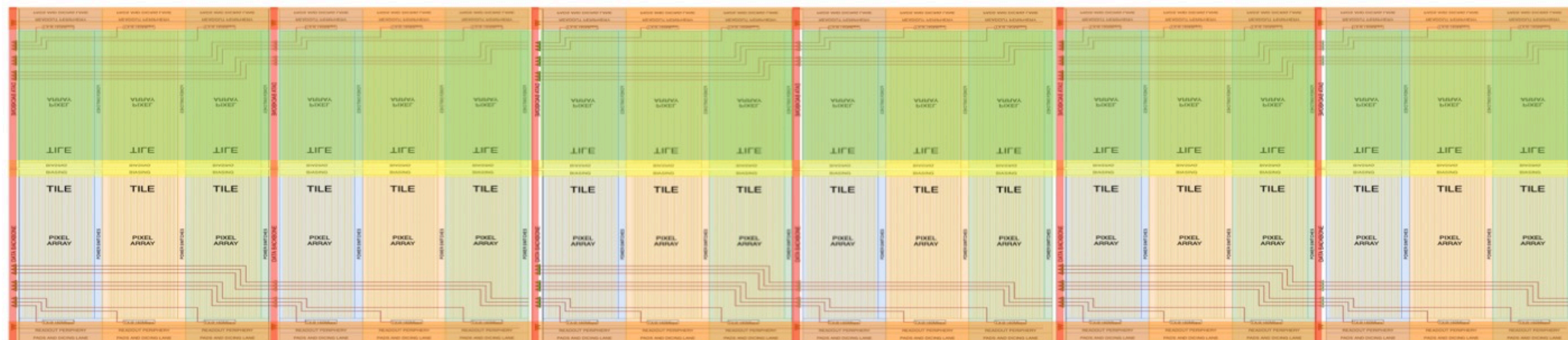



# SVT Workfest: Cooling

Nicole Apadula (LBNL)

## Corrugated prototype test pieces

Each piece → 2 layers 34 gsm veil + 5 layers resin

Face sheets glued with 9309 adhesive in 5 mm strips

Final size of prototype test piece = 22.4 cm x 20.2 cm

Final weight of prototype test piece = 22.5 g

Density = 497 gsm → ~ 0.12% X/X0

Silicon ~0.05% X/X0, adhesive 0.01-0.02% X/X0

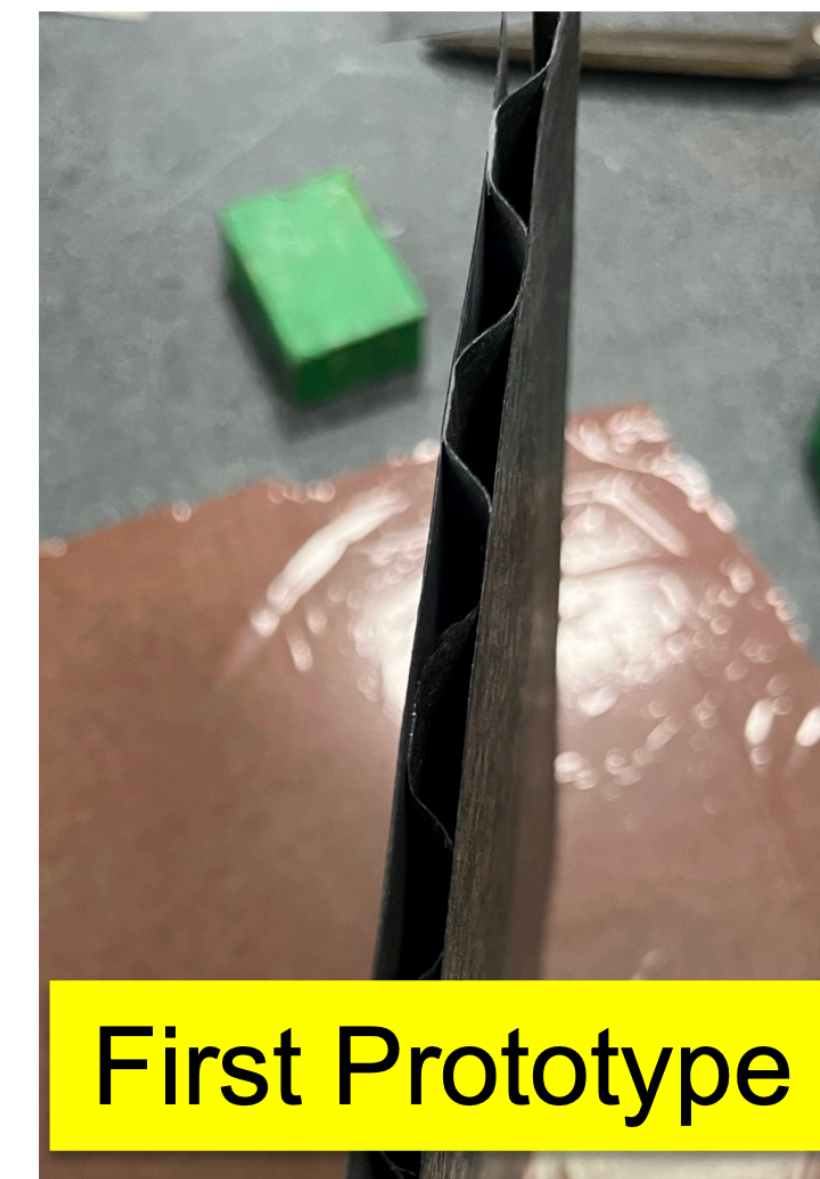
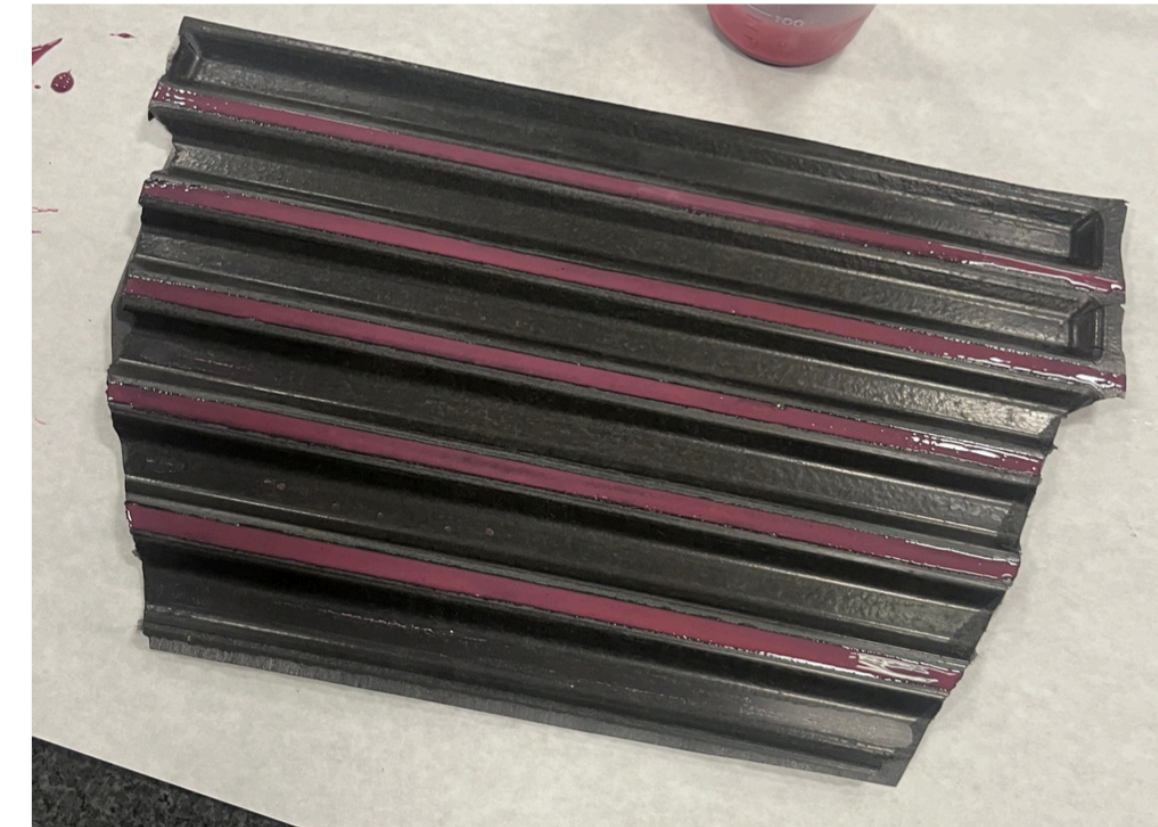

First Prototype



# SVT Workfest: Cooling

Nicole Apadula (LBNL)

## Results: air flow through corrugation

- No issues cooling the matrix
- LEC (Periphery) trending in the right direction
- Next steps:
  - Add foam under the LEC
  - Improve thermal conductivity
  - Better air control

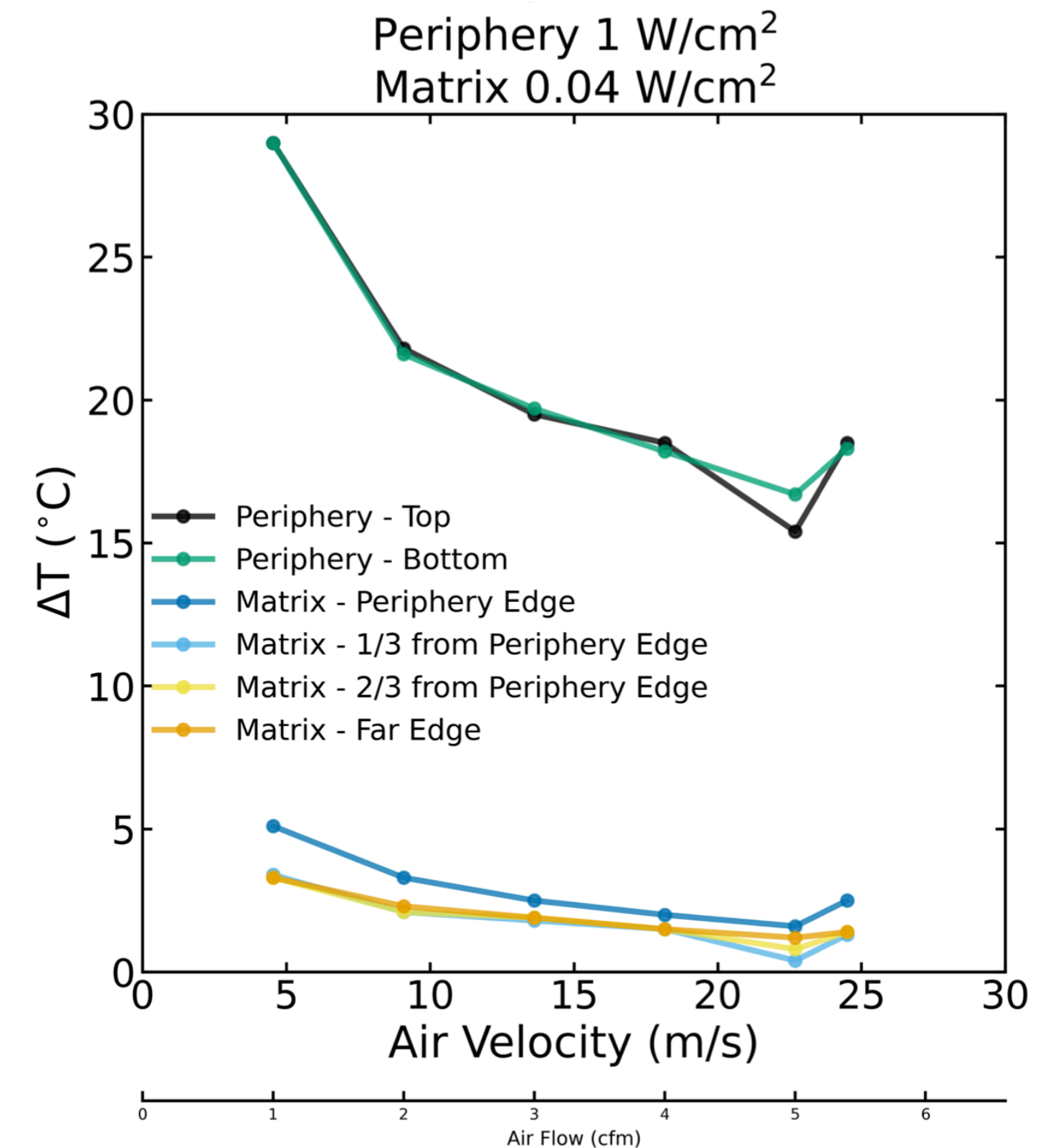
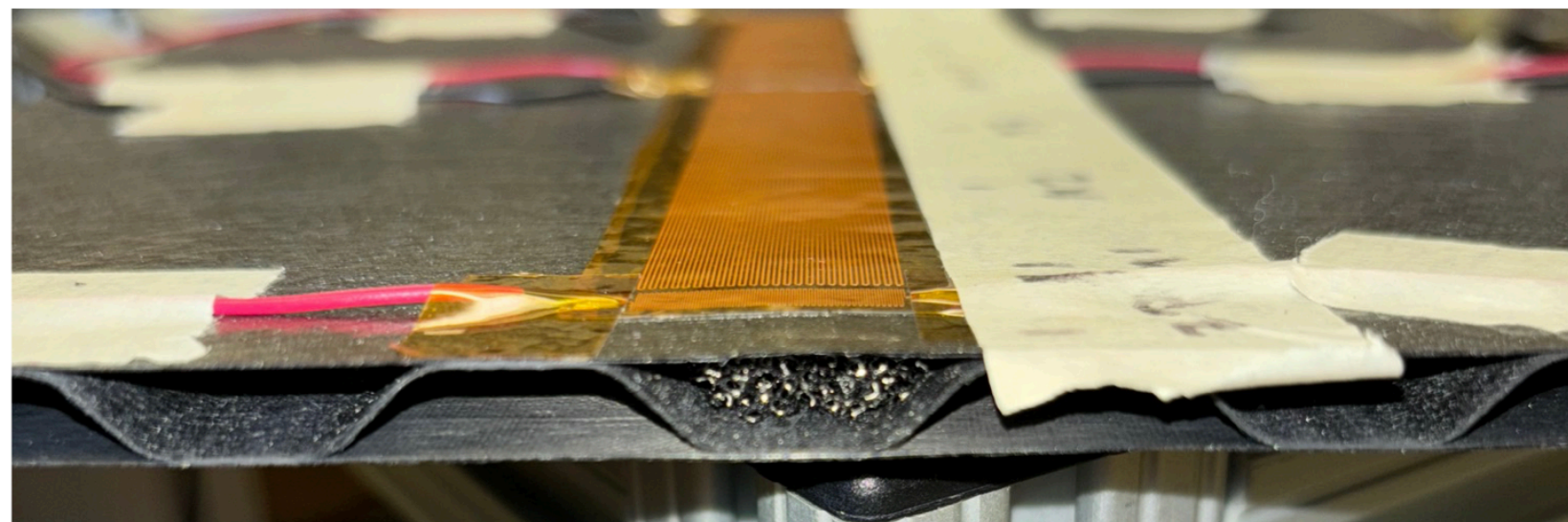

*Uptick at highest velocity possibly due  
to thermocouple breakage*

# SVT Workfest: FPC

Marcello Borri (Daresbury)

## Block diagram for a sequence of 4 LAS (2/2)

- A total of 7 differential lines every 4 LAS:
  - 2 diff lines for control;
  - 1 diff line for global clock;
  - 4 diff lines for HS data:
- **Foot-print 4 LAS: (7 diff lines) x (500um/diff lines) = 3.5mm**
- % fill factor of LAS width (19mm):  $(3.5/19) * 100 = 18\%$ 
  - It was 84%+84%=168% originally!
- Signal ratings considerations:
  - Slow control: 5Mb/s (or 10Mb/s);
  - Global clock: 160MHz (or 320MHz);
  - Data speed 5.12 Gb/s (or 10Gb/s TBC);
  - Expected highest  $\Delta V \sim 10V$  (  $\sim 2.5V / \text{LAS}$  ) x (4 LAS) );
  - Highest current  $\sim 2.5$  A;

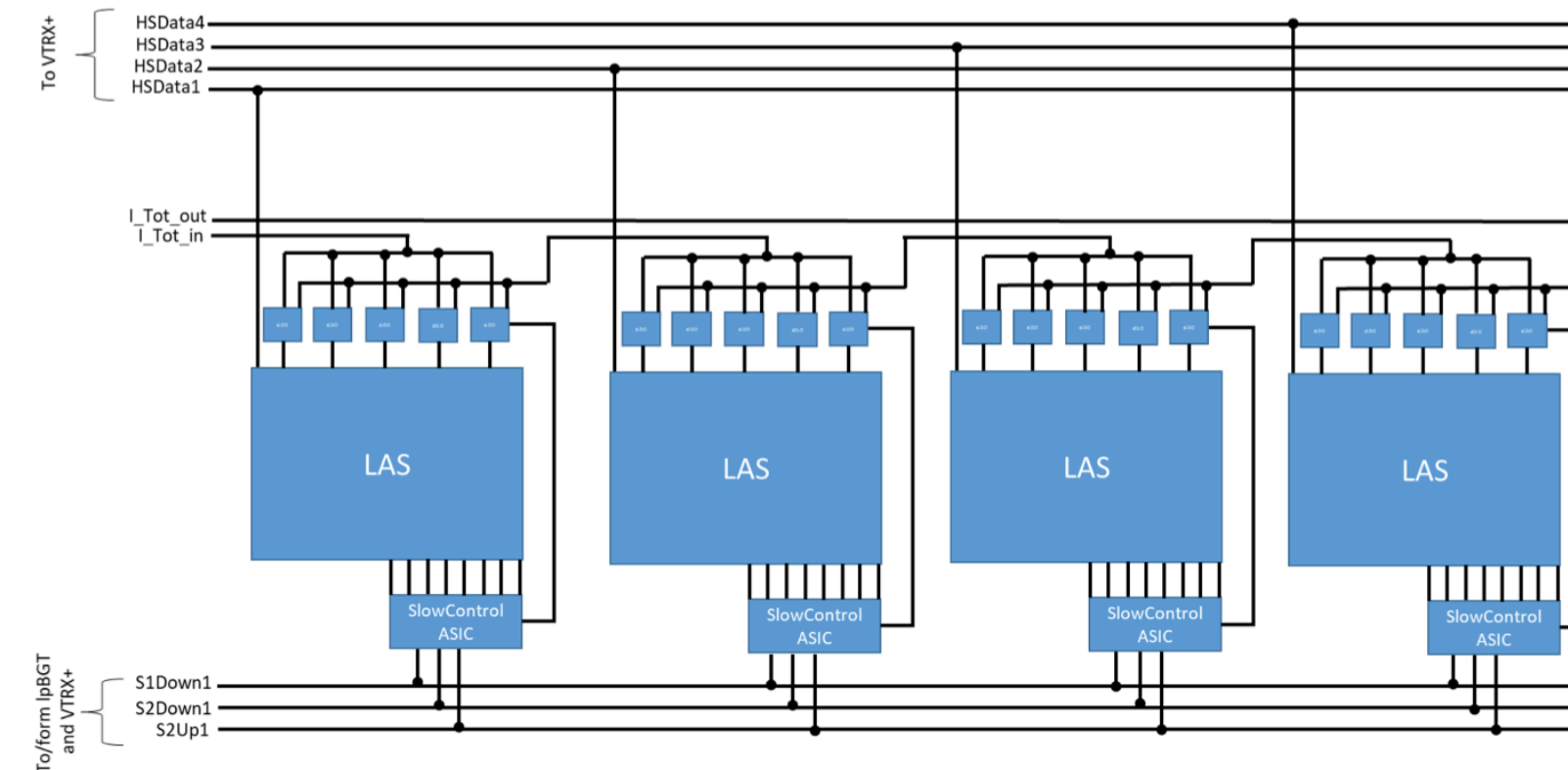



# SVT Workfest: FPC

Marcello Borri (Daresbury)

## Considerations on material budget

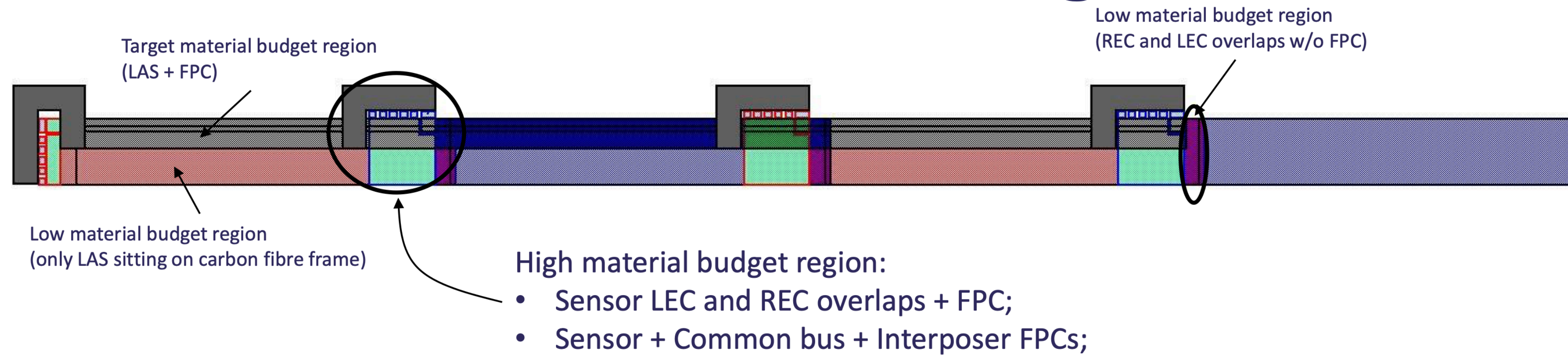

The majority of the area is equal to or lower than the target material budget.

Improvements are possible for the regions above the target material budget:  
 exploit synergy w mechanics layout,  
 improved design maturity of auxiliary components, consider Si interposer etc...

	Components	Thickness (um)	Material	X0 (cm)	X0 (%)	Comment
HIC	FPC metal layers	50	Al	8.897	0.056	25um/layer x 2 layers = 50um
	FPC insulating layers 1	75	UPILEX-S75	28.57	0.026	UPILEX-S75 is a type of polyimide
	FPC insulating layers 2	40	Coverlay	28.57	0.014	20um/layer x 2 layers = 40um, coverlay is polyimide
	Pixel Chip	50	Si	9.37	0.053	
	Glue	50	Araldite2011	39.07	0.0128	ATLAS assumes phenol epoxy C6 H6 O
Total (FPC + Pixel chip + glue)					0.163	
Total w/o glue (FPC + Pixel chip)					0.150	
Total FPC only					0.096	consider Si interposer as option: Si 50um thin equates to X0 (%) 0.053. N.B. ~45% saving in material budget

# SVT Workfest: Mechanics

Georg Viehhauser (Oxford)

## From ITS3 to ePIC SVT IB

- Plan to develop bending procedure for SVT L0 (L1)

### Main differences & challenges wrt ITS3:

- x2 larger radius (18 → 36 mm)\*
- need to bend 2 sensors for each half-layer
  - \* will increase to ~19/~38 mm with ITS3 ER2/3 sensors

### Possible strategies:

- embedding (2 sensors):** try to exploit “embedding” the two sensors in kapton foils and bend them as a single object → **half-layer**
- independent bending:** bend each of the two sensors separately and glue them on independent support structures → **quarter of layer**

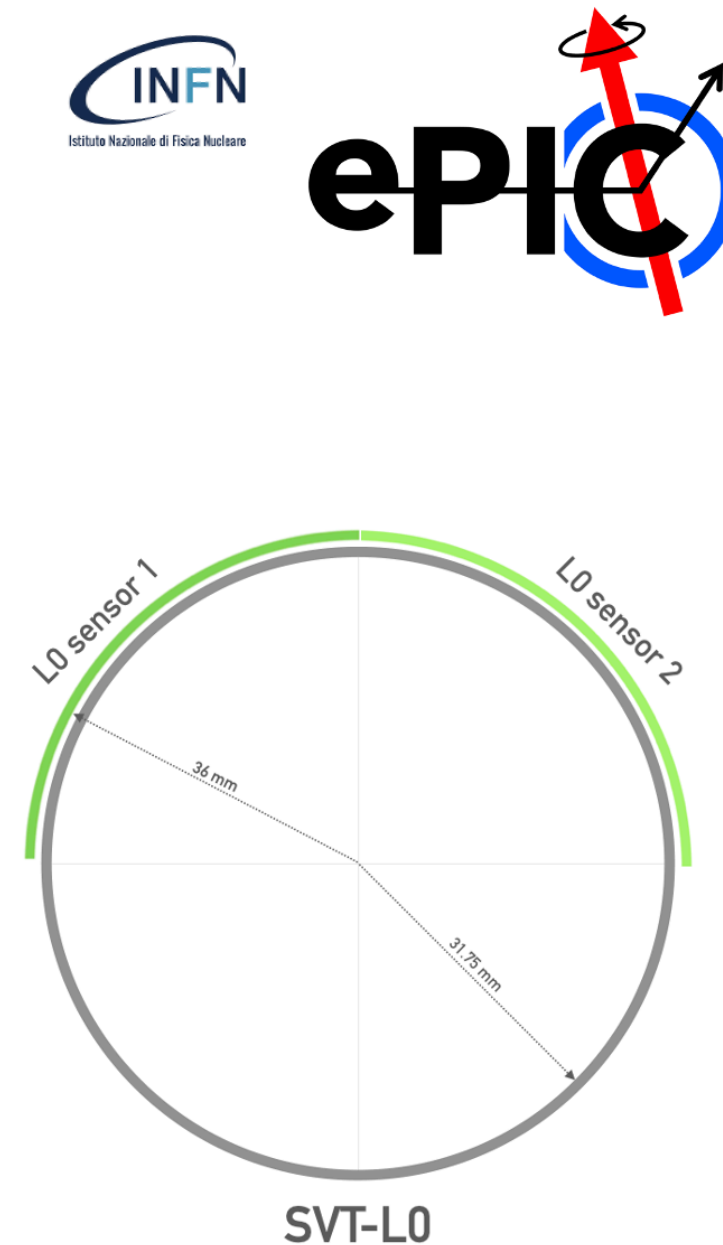
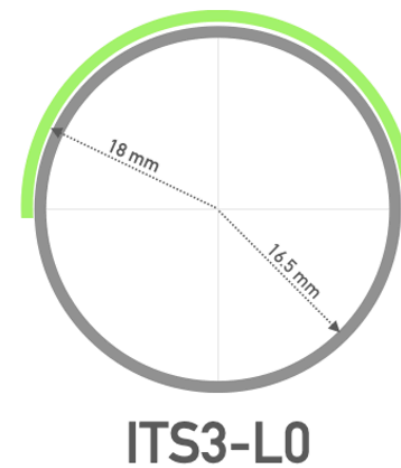

8

## From ITS3 to ePIC SVT IB

- Different approach needed for L2 wrt L0/L1

### Bending procedure:

- 4 sensors for each half-layer
- embedding all 4 or just 2 sensors, as well as independent (single sensor) bending, to be evaluated in connection with the next point

### L2 specific issues and required development:

- L2 radius quite large (~120 mm) and far away from L1 (~70 mm, compared to L1-L0 ~6 mm)
- need to define mechanical connection to L1
- also aspects connected to cooling (in a much larger volume) will be completely different wrt L0/L1 (and to ITS3) and will require dedicated solutions

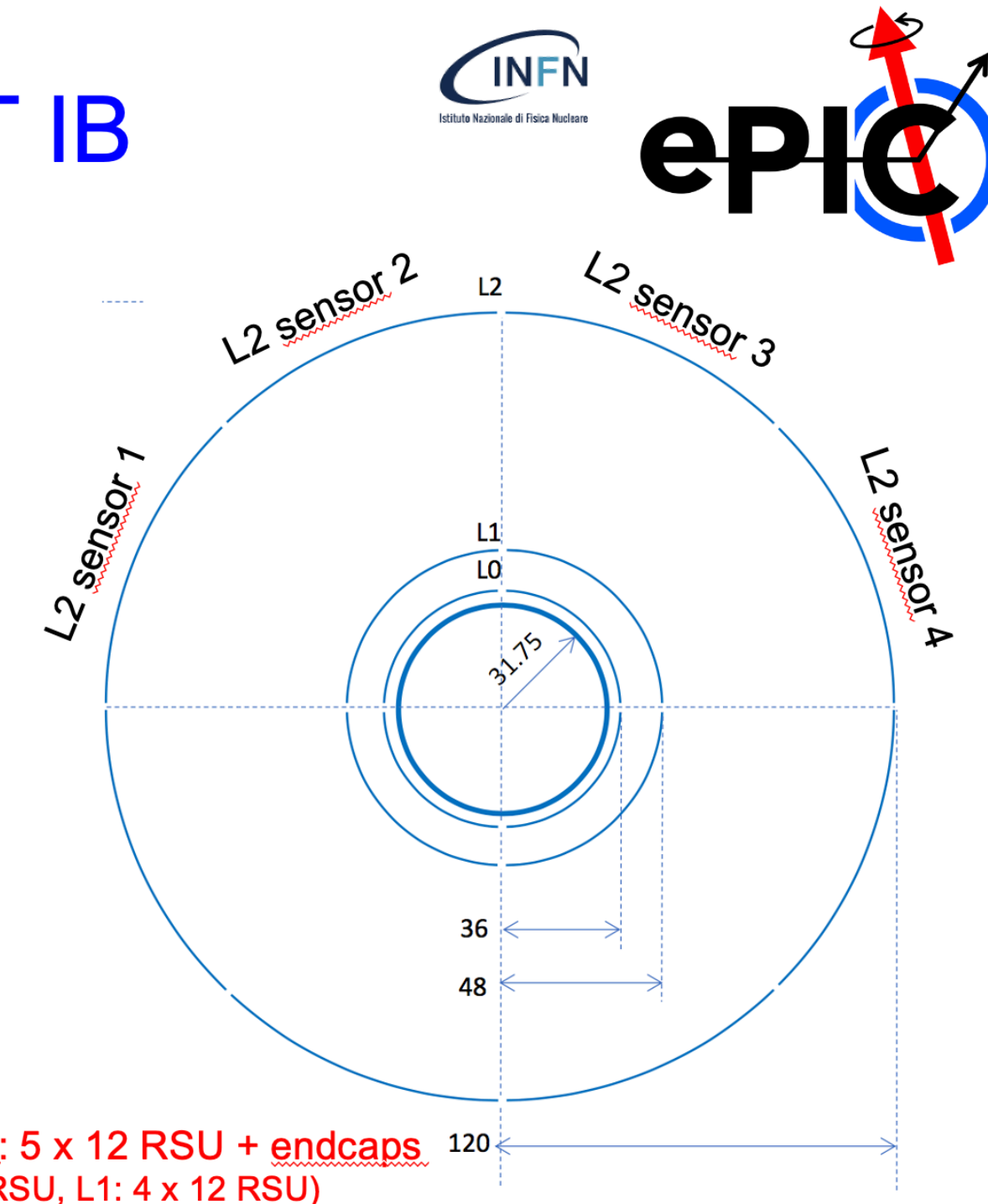

Reminder: SVT IB — three innermost curved silicon barrel layers



# SVT Workfest: Mechanics

Georg Viehhauser (Oxford)

**First** Concept



- **Sensor assembly**

Sensor geometry used (approximate 5RSUs)

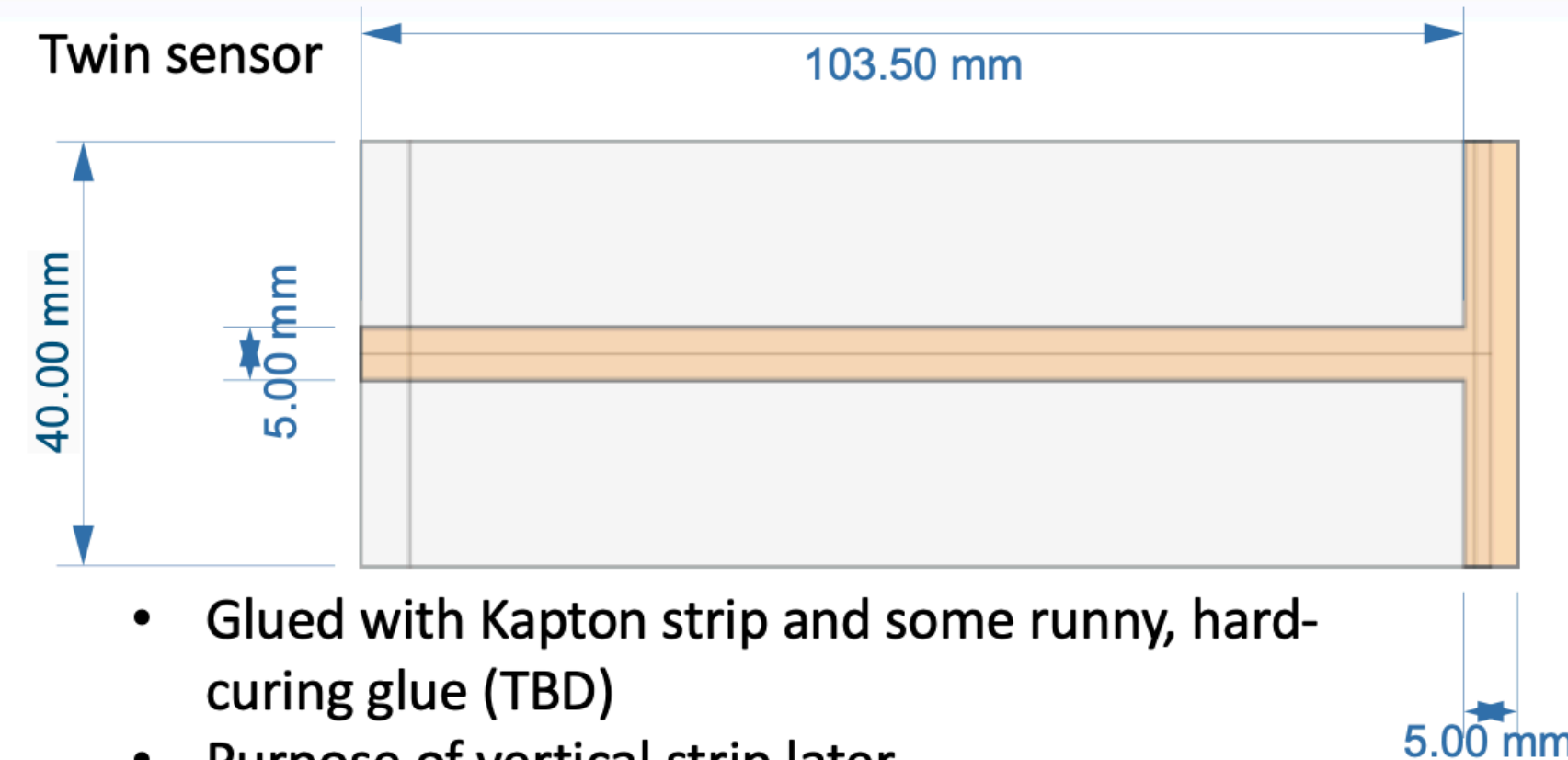
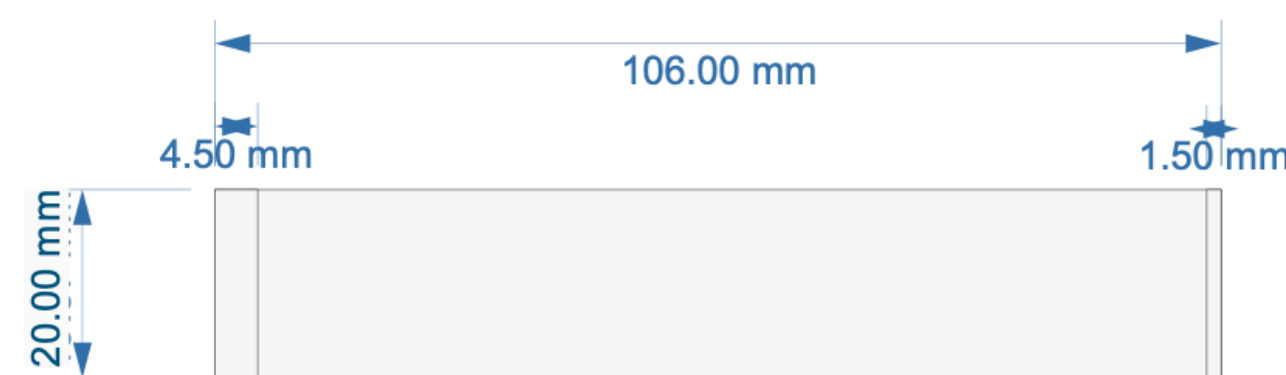

- Glued with Kapton strip and some runny, hard-curing glue (TBD)
- Purpose of vertical strip later

- **Core of stave is made of array of foam blocks**

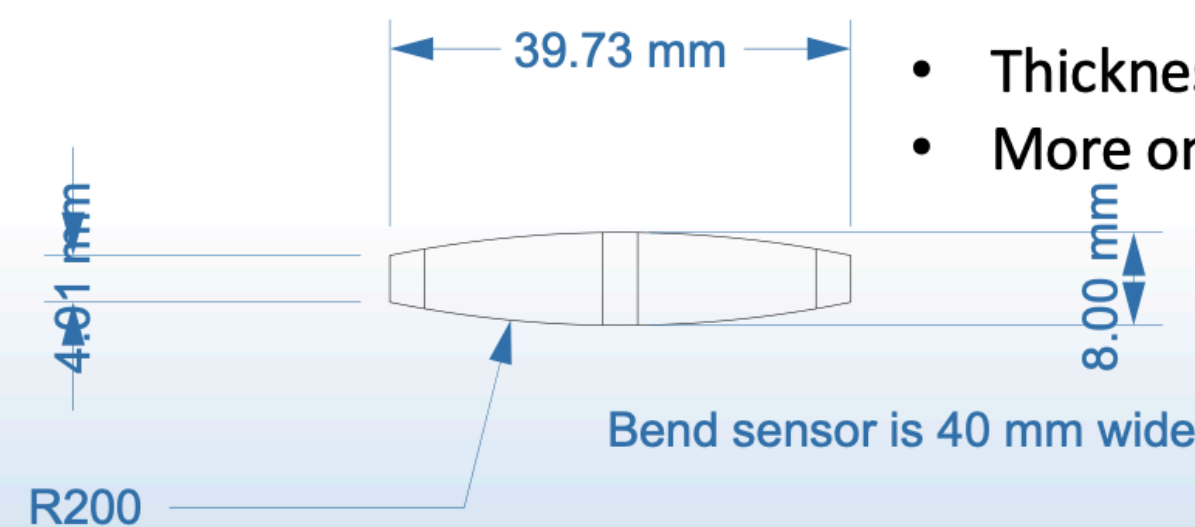

- Thickness and curvature arbitrary
- More on optimization later

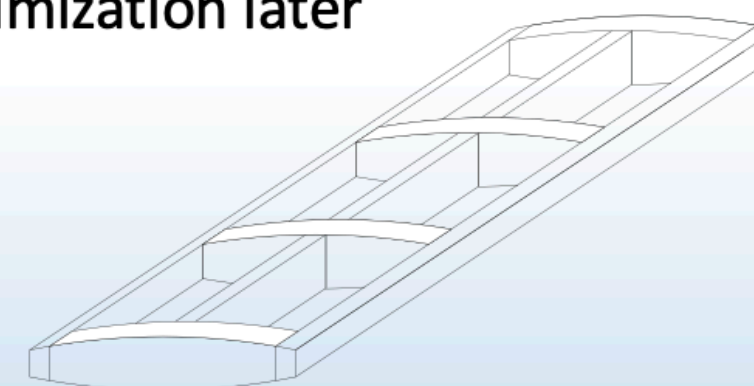

- Crossribs are K9
- Central spar 3% RVC
  - Could be thinned to hourglass shape
  - Alternatively, carbon fibre I-beam
- Edges are 3% RVC
  - Alternatively, 3% Al, if we want to run the power bus through this
    - In that case the Al would be in shorter sections for serial powering

First concept for the two stave-based Outer Barrel layers

Disks not shown here; corrugated concept already shown as part of cooling slides

# SVT Workfest: Mechanics

Andy Jung (Purdue)



## Global support structure for SVT

- Design of supports for SVT depends on support hierarchy and detector “integration” and assembly
- Dictates what structures are needed to support SVT and how...
- Naturally, as light-weight as possible but services and “cooling” needs space and need to be considered
- Lets first look at an integration sequence of “**inner detectors**”
- Nomenclature: large global inner detector CF support tube
- Suggest: “GIST”

“Inner detectors” = inside of the large global CF support tube

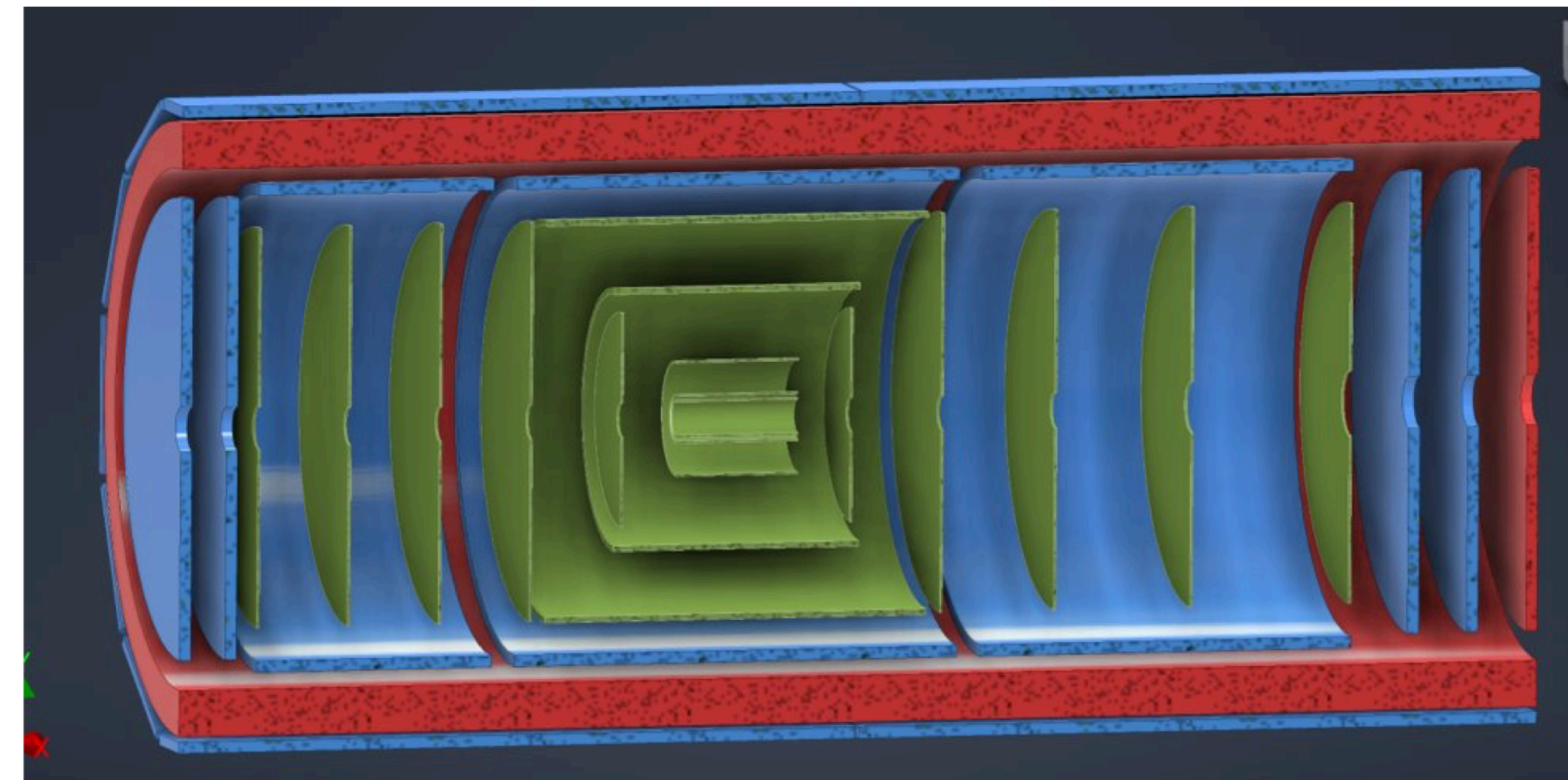



# SVT Workfest: Mechanics

Andy Jung (Purdue)



## Integration sequence

8. Beam pipe comes in next before the silicon tracker so that there is still enough room for bake out and other beam pipe installation sequence.

Caveat: **Requires full half hemispheres of SVT**

BEAM pipe is after the silicon tracker support rails and structures – not shown in CAD

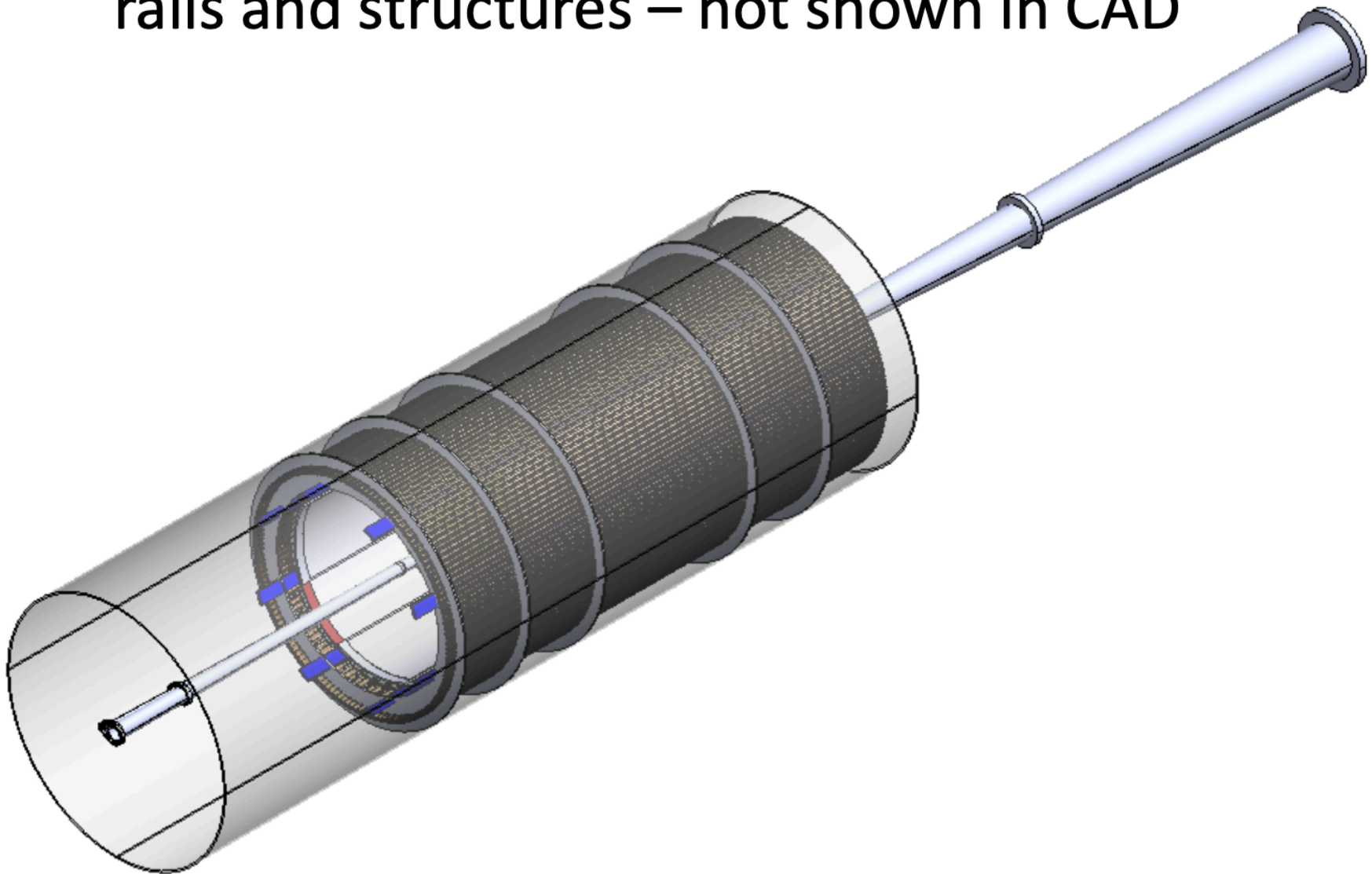

9. Inner silicon detectors are then slid on these rails from electron and hadron side – this is NOT symmetric – the structures will be split such that the changing diameter of the pipes is taken into account. A schematic is below.

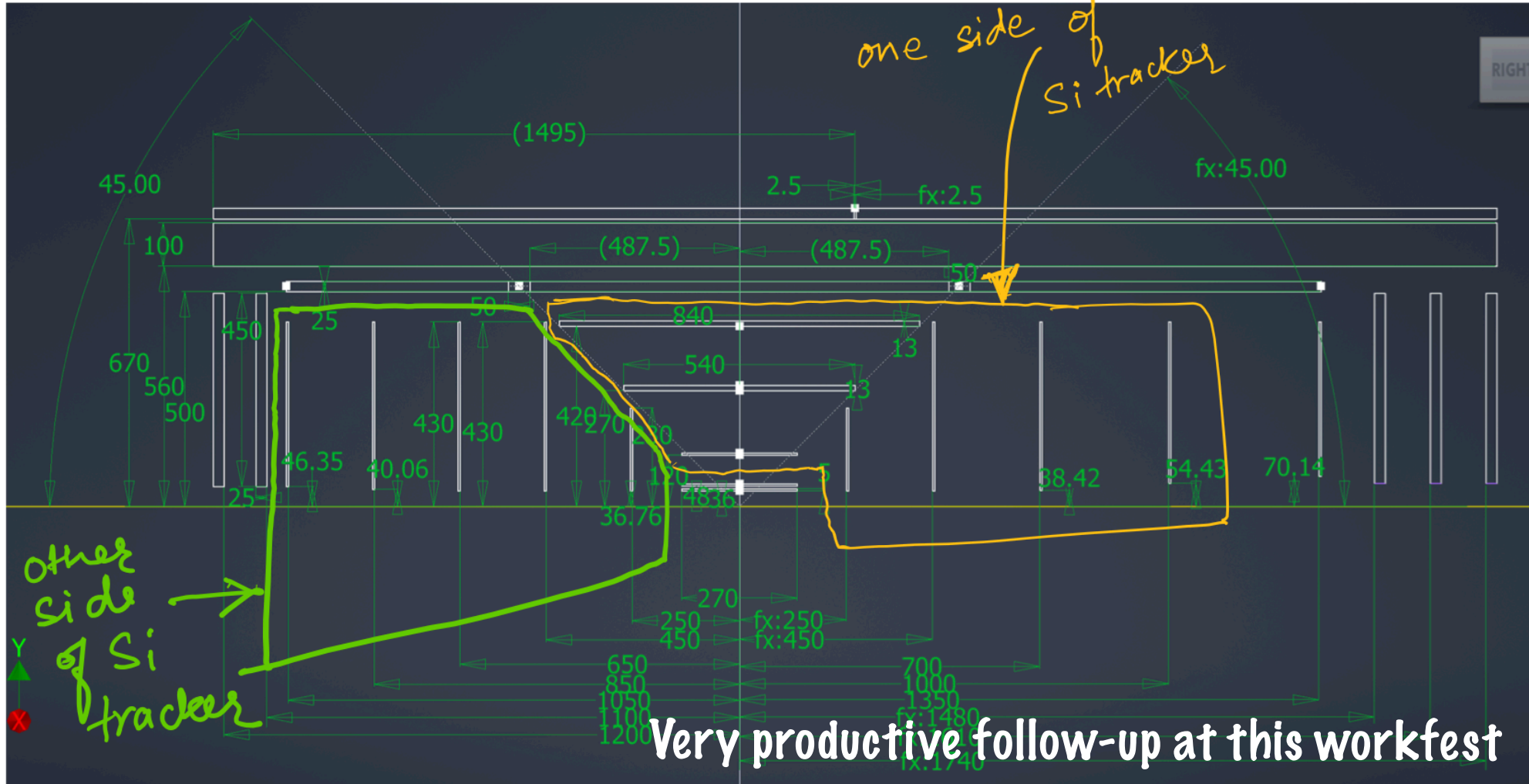

# SVT Workfest: in lieu of a summary — towards TDR

WP1: Sensor design (Iain Sedgwick, TBD/TBA)

- Define ancillary chip specs, design, submit
- Continue partnership with ALICE-ITS3 and understand design
- Pending access to DB, initial work on EIC-LAS (RSU and data MUX)

WP2: Sensor testing (Lukas Tomasek, Gian Michele Innocenti)

- Test ancillary chip if available
- Progress testing of ER1

WP3: Electrical interfaces (Marcello Borri, TBD)

- Prototype and data speed on maximum length FPC (~ 30 - 40 cm)
- Progress overall design optimization

WP4: Layers and Disks (Domenico Elia, Georg Viehhauser, Nicole Apadula)

- Conceptual design of layers and disks, including mechanics, cooling, readout, powering, until the electrical/optical interface
- Choice of cooling
- Thermo-Mechanical prototypes of IB, OB, disks
- Support structure within the subsystem how to keep everything together

**Overall approach:**

**Work towards a fully developed detector concept**

**Demonstrate the various SVT technologies, as far as possible**

**People identified here are work package coordinators; many areas to engage**

**New collaborators welcome!**



# SVT Workfest: in lieu of a summary — towards TDR

WP5: Readout and power (Jo Schambach, James Glover)

- Data: Define scheme all the way from VTRX+ at end of stave/disks to FELIX, including possible board half way for further data aggregation
- Slow control/clock: Define protocol for multiplexed transmission to staves/disks (in close collaboration with WP1)
- Test of readout components, readout boards concept

WP6 (Andy Jung, Eric Anderssen)

- Definition of services: cables for power, fibers for signals, cooling, other... (in close collaboration with the project, WP5, DAQ group)
- Definition of SVT support (in close collaboration with WP4)
- Definition of global support and integration sequence (in close collaboration with the project)
- Envelope model

Several Work Packages not covered here

General

- Refine radiation and hit rate estimates
- Detailed detector geometry implementation and simulations
- Organizational aspects,
  - Institute roles etc
  - Schedule
  - Cost
  - Risk
  - ...
- Assembly, installation, and maintenance

**Overall approach:**

**Work towards a fully developed detector concept**

**Demonstrate the various SVT technologies, as far as possible**

**People identified here are work package coordinators; many areas to engage**

**New collaborators welcome!**

# Tracking Workfest

Focus here (only) on the Wednesday session

Original aim was to advance the detector description in simulations

Several of the success factors were similar to the SVT workfest;

- the talks, for example, provided excellent status overviews and identified opportunities to engage,

Still, my personal assessment is that the original aim was not met;

- probably a combination of factors
- oversubscription and workforce shortages are almost certainly a factor.





# Tracking Workfest — Wednesday session

**10:15 AM → 12:00 PM Tracking** 📍 Auditorium (APS Conference ...)

<https://lbnl.zoom.us/j/94961740853?pwd=eWhFK0VUMS9mYlZlK3ZkQklzS0syZz09>

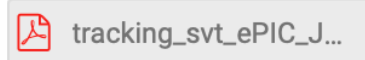
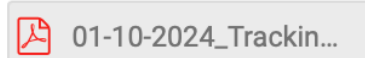
**Conveners:** Ernst Sichtermann (Lawrence Berkeley National Laboratory), Matt Posik (Temple University)

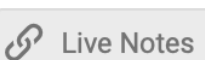
- 10:15 AM Session Introduction** ⌚ 5m  
**Speakers:** Ernst Sichtermann (Lawrence Berkeley National Laboratory), Matt Posik (Temple University)  

- 10:20 AM SVT Subsystem** ⌚ 20m  
**Speaker:** Shujie Li (Lawrence Berkeley National Laboratory)  

- 10:40 AM MPGD Subsystem** ⌚ 20m  
**Speaker:** Matt Posik (Temple University)  

- 11:00 AM AC-LGAD ToF Subsystem** ⌚ 20m  
**Speaker:** Satoshi Yano  

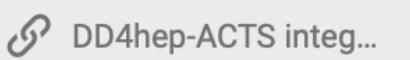
- 11:20 AM TDR Preparation Discussion** ⌚ 40m  
**Speakers:** Ernst Sichtermann (Lawrence Berkeley National Laboratory), Matt Posik (Temple University)  
 

**1:00 PM → 2:15 PM Tracking** 📍 Auditorium (APS Conference ...)

<https://lbnl.zoom.us/j/94961740853?pwd=eWhFK0VUMS9mYlZlK3ZkQklzS0syZz09>

**Conveners:** Ernst Sichtermann (Lawrence Berkeley National Laboratory), Matt Posik (Temple University)

- 1:00 PM BIC Subsystem** ⌚ 20m  
**Speakers:** Sylvester Joosten (Argonne National Laboratory), Wouter Deconinck (University of Manitoba)  

- 1:20 PM Using DD4HEP Geometry in ACTS** ⌚ 20m  
**Speakers:** Sakib Rahman (University of Manitoba), Sakib Rahman (affiliate@jlab.org;member@jlab.org)  

- 1:40 PM Workfest** ⌚ 35m  
**Speakers:** Ernst Sichtermann (Lawrence Berkeley National Laboratory), Matt Posik (Temple University), Shujie Li (Lawrence Berkeley National Laboratory)

**2:45 PM → 3:45 PM Tracking** 📍 Auditorium (APS Conference ...)

<https://lbnl.zoom.us/j/94961740853?pwd=eWhFK0VUMS9mYlZlK3ZkQklzS0syZz09>

**Conveners:** Ernst Sichtermann (Lawrence Berkeley National Laboratory), Matt Posik (Temple University)

- 2:45 PM Workfest** ⌚ 50m  
**Speakers:** Ernst Sichtermann (Lawrence Berkeley National Laboratory), Matt Posik (Temple University)
- 3:35 PM Workfest Summary** ⌚ 10m  
**Speakers:** Ernst Sichtermann (Lawrence Berkeley National Laboratory), Matt Posik (Temple University)

# Tracking Workfest — Wednesday session

Satoshi Yano (Hiroshima)

## Detector Layout

- BTOF is composed of stave like structure to make a cylindrical
- Radius is 60 - 63 cm from the beam pipe covering  $-117 < z < 171$  cm
- Total material budget in acceptance is  $0.01 X/X_0$
- FTOF is composed of modules to make a disk
- Radius is 8 - 67 cm from the beam pipe covering  $1.74 < \eta < 3.83$
- Total material budget in acceptance is  $0.025 X/X_0$

BTOF shape

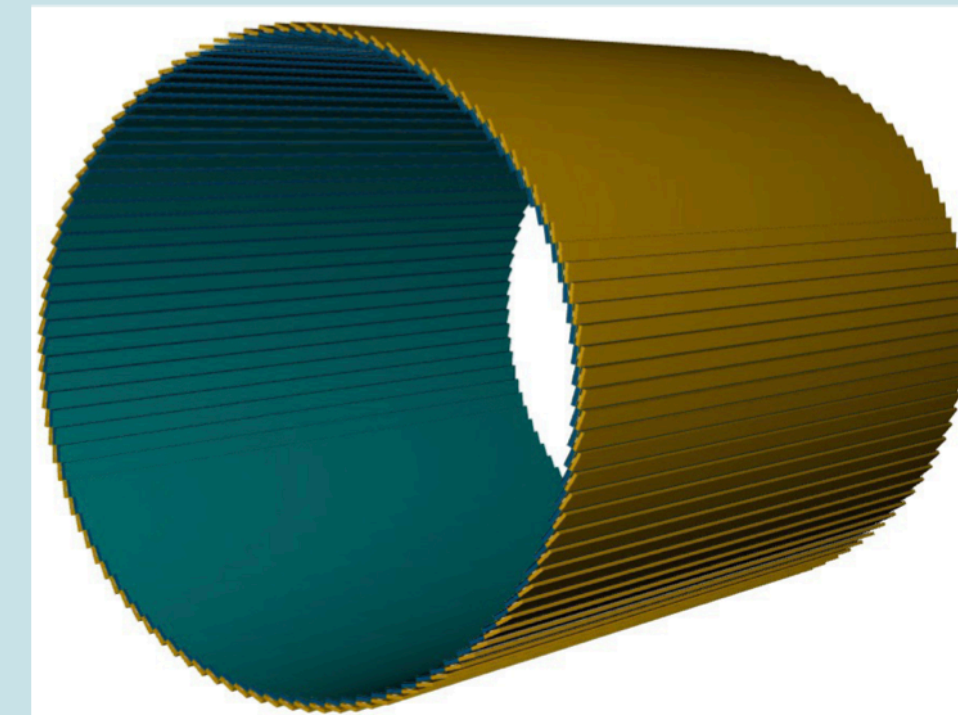

FTOF shape

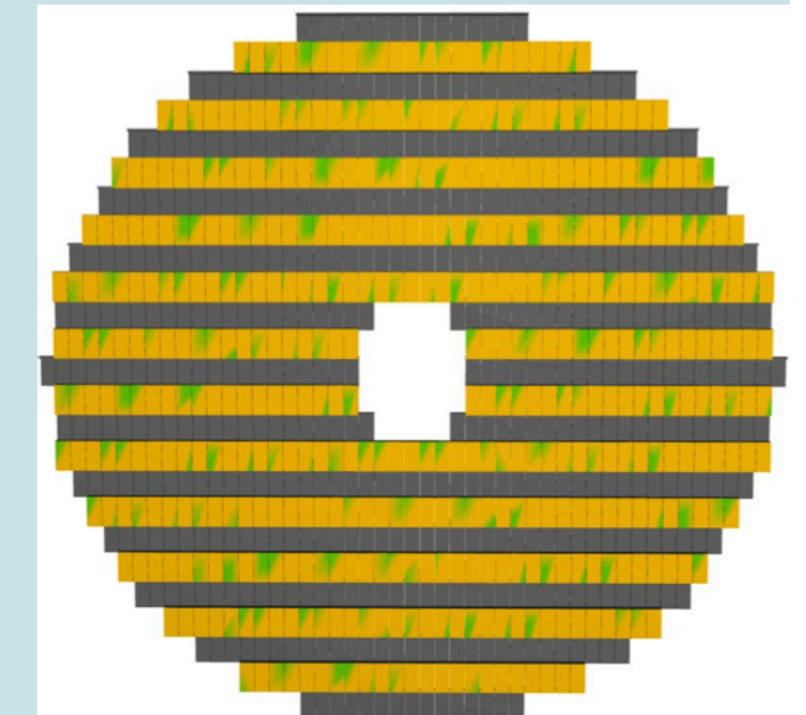

Module top view

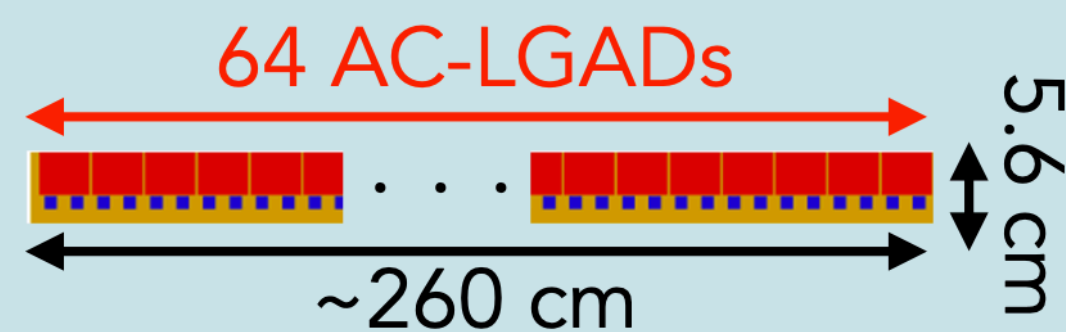

Cylindrical structure by modules

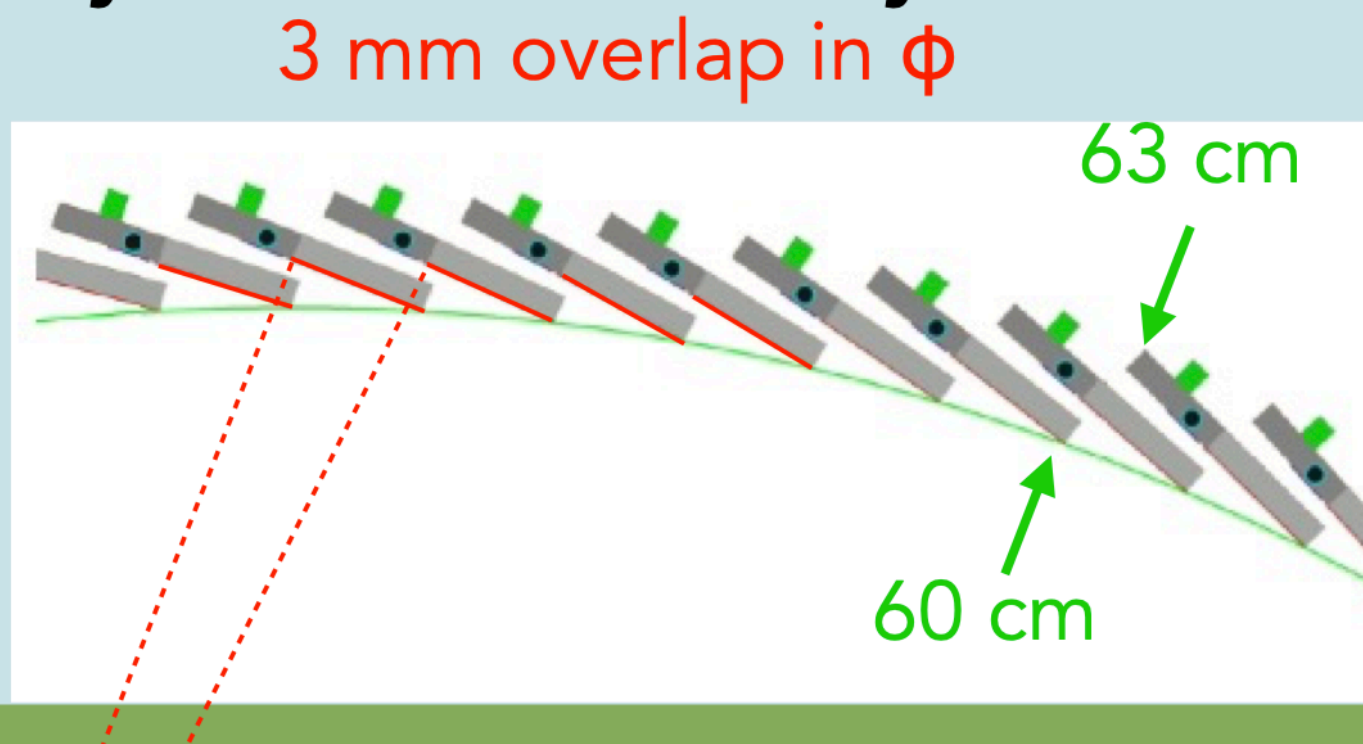

Material budget of BTOF

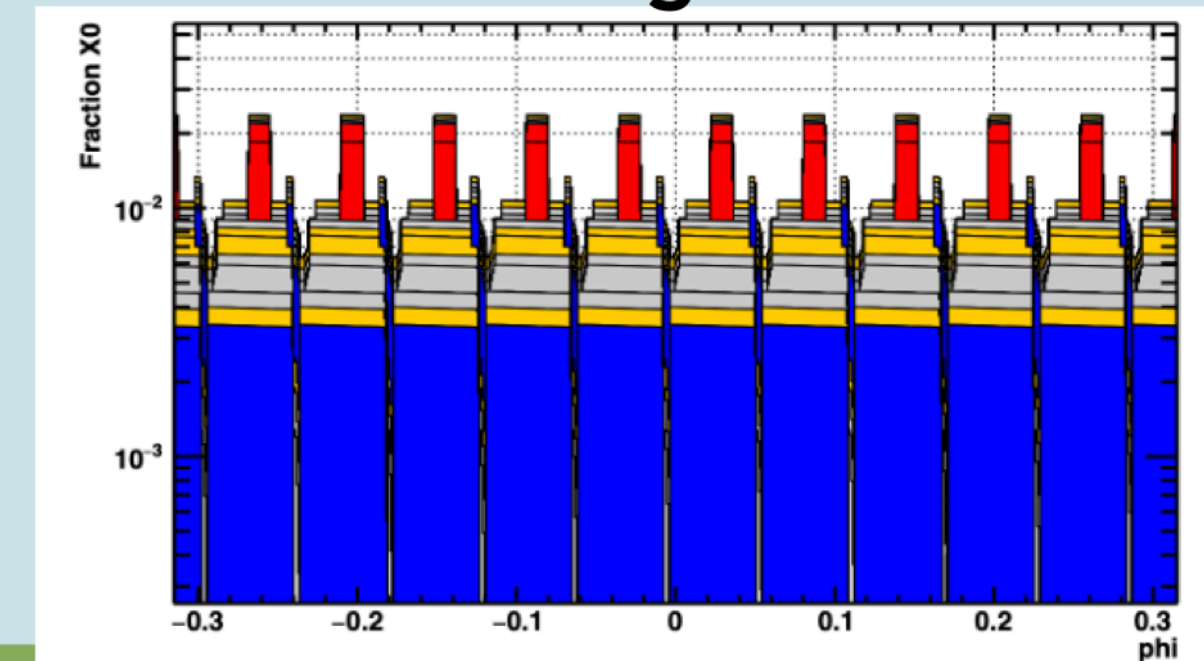

ToF geometrical description is far along in simulations



# Tracking Workfest — Wednesday session

Satoshi Yano (Hiroshima)

## Mimic the analog signal in the DD4hep simulation

[From Souvik Paul's presentation](#)

- Deposit energy in the active material is obtained from GEANT
  - The input charge is calculated from the energy
- Realistic signal shape in the test beam is used
- The relationship between maximum voltage and input charge is extracted from real data

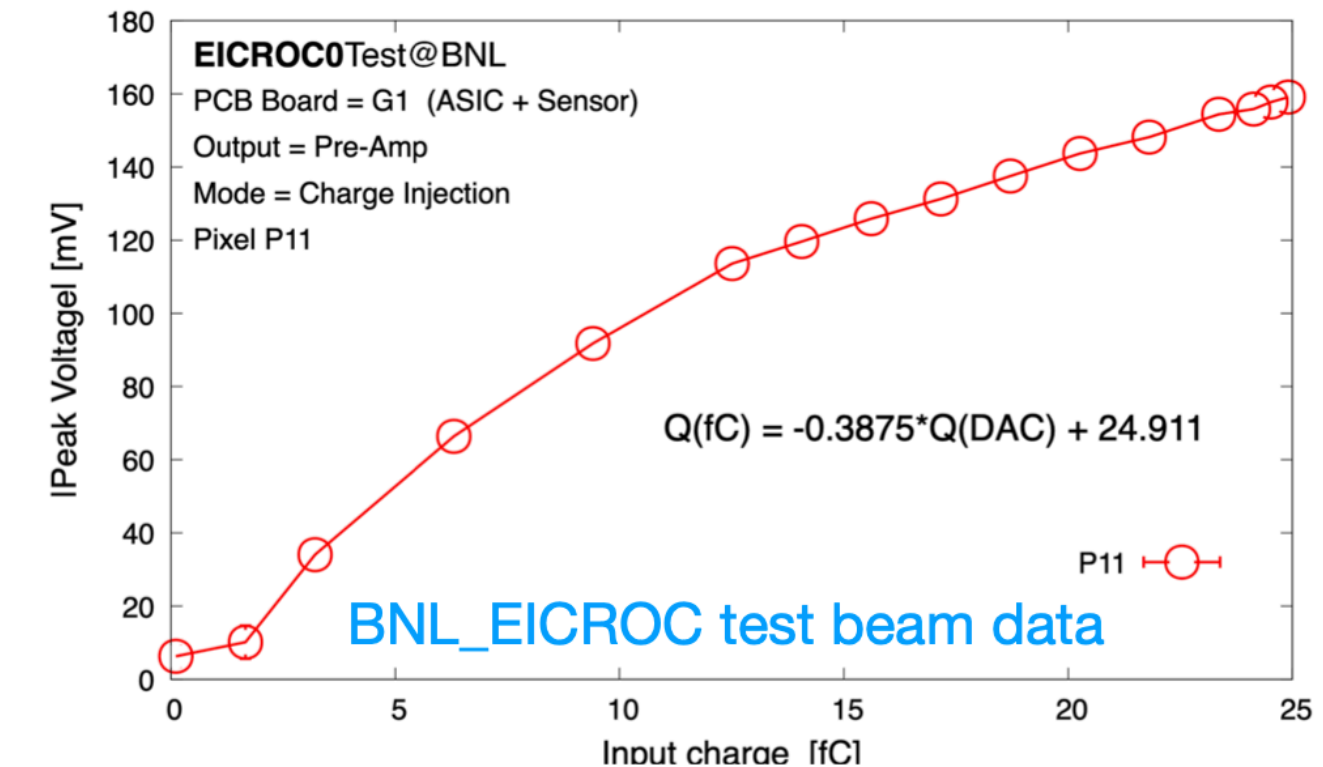
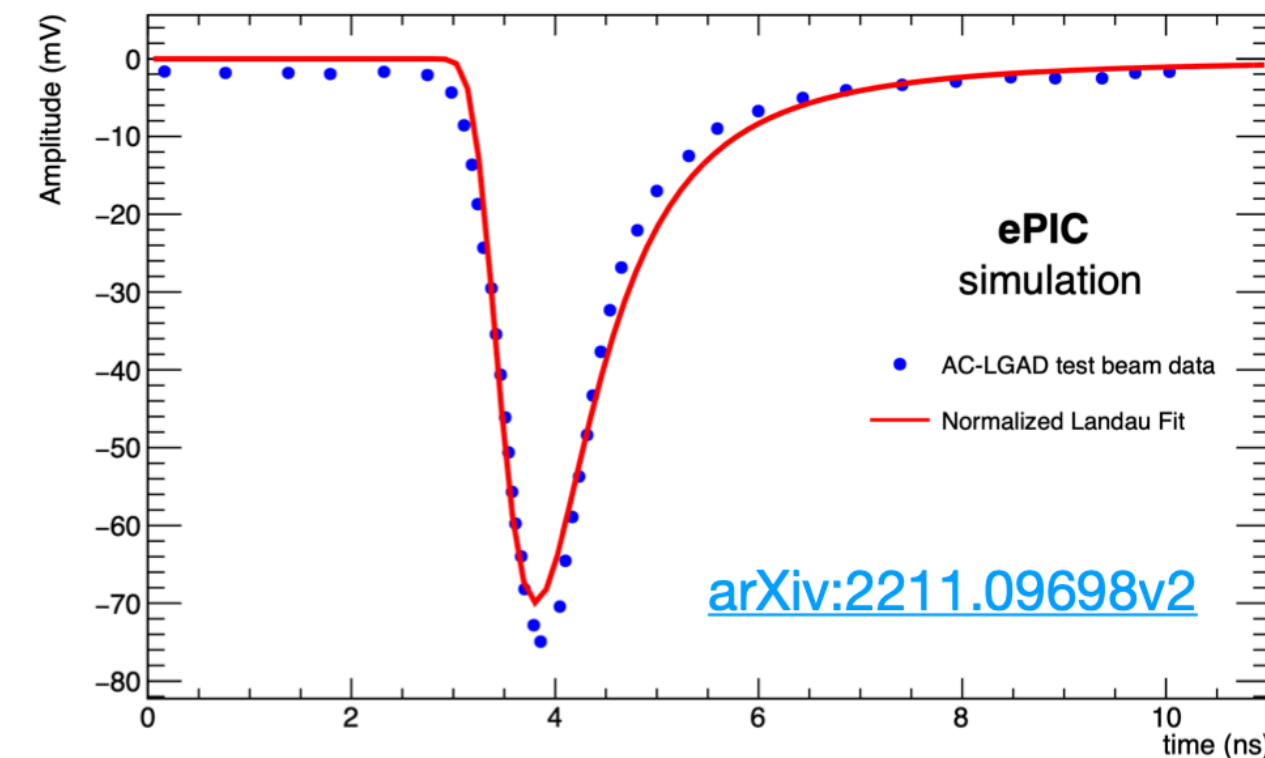
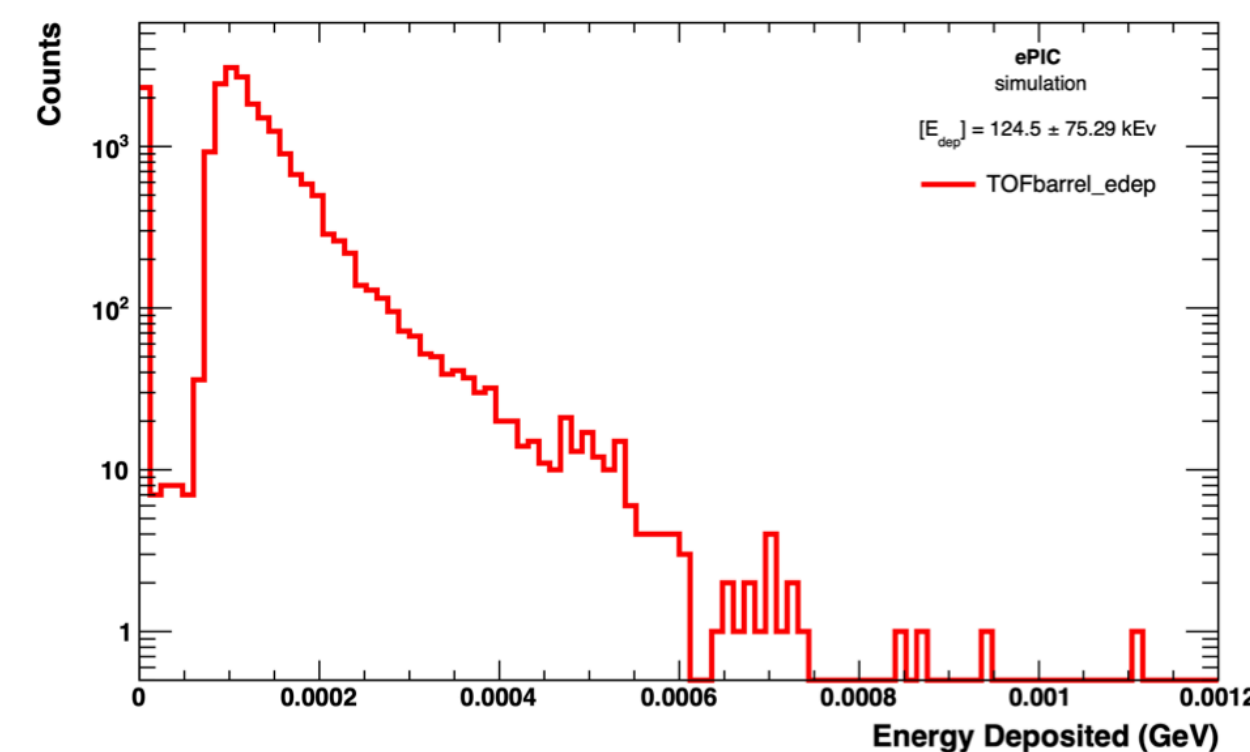

# Tracking Workfest — Wednesday session

Shujie Li (LBNL)

## Outer Barrels

ITS2 barrel stave:

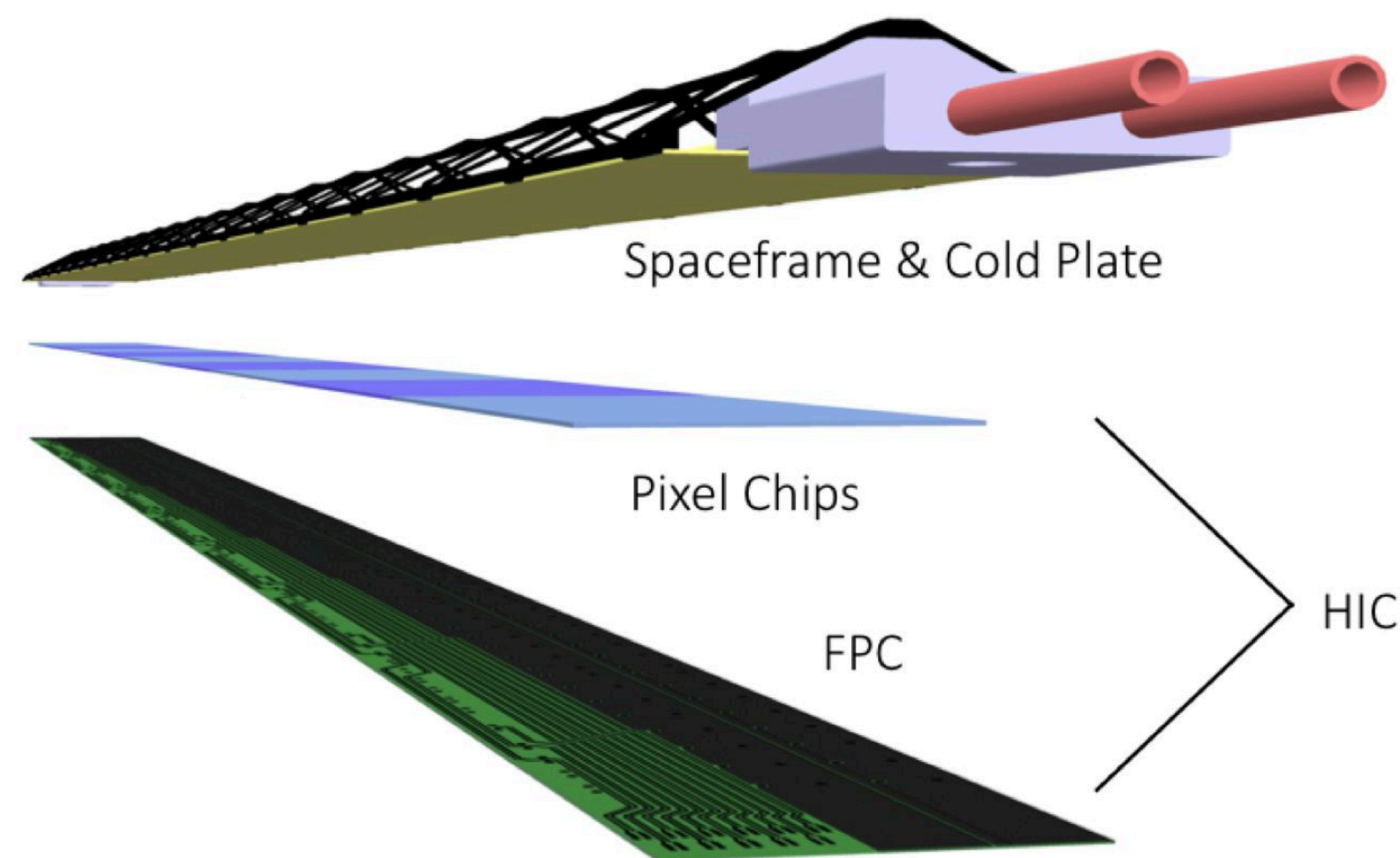

ePIC simulation:

44 slightly tilt triangle staves  
(silicon + Al + carbon fiber  
plates)

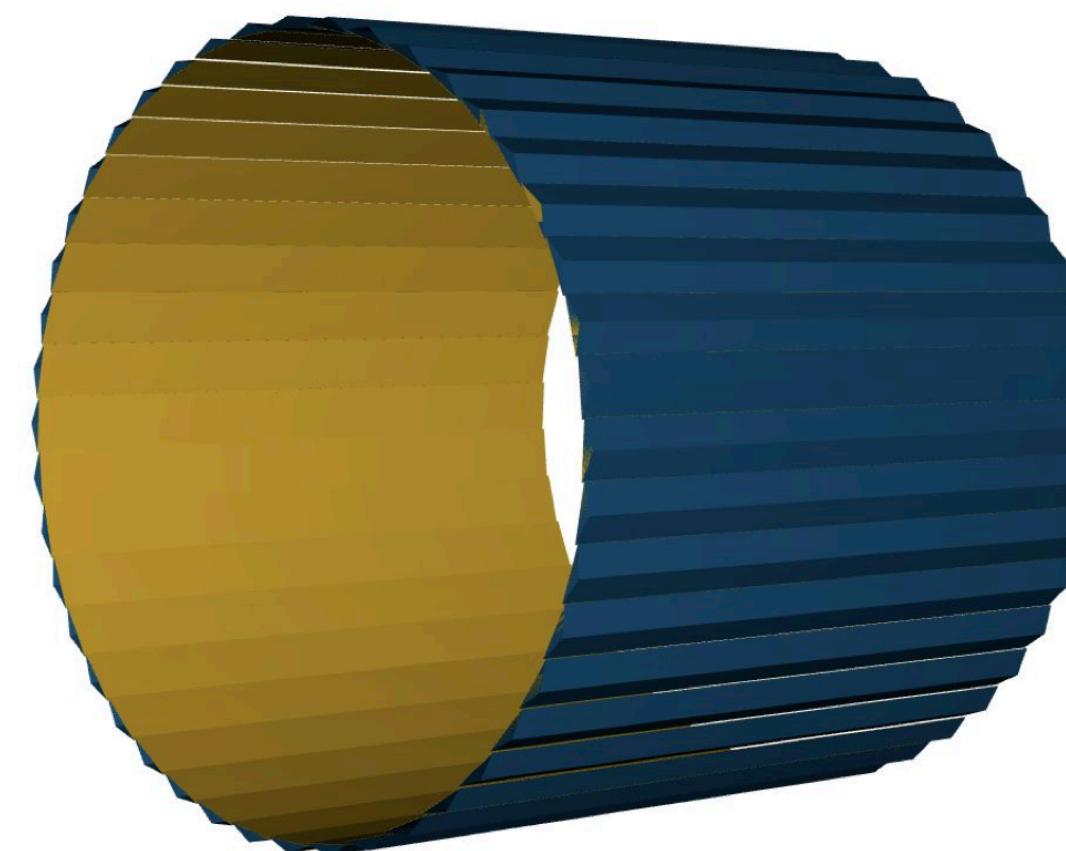
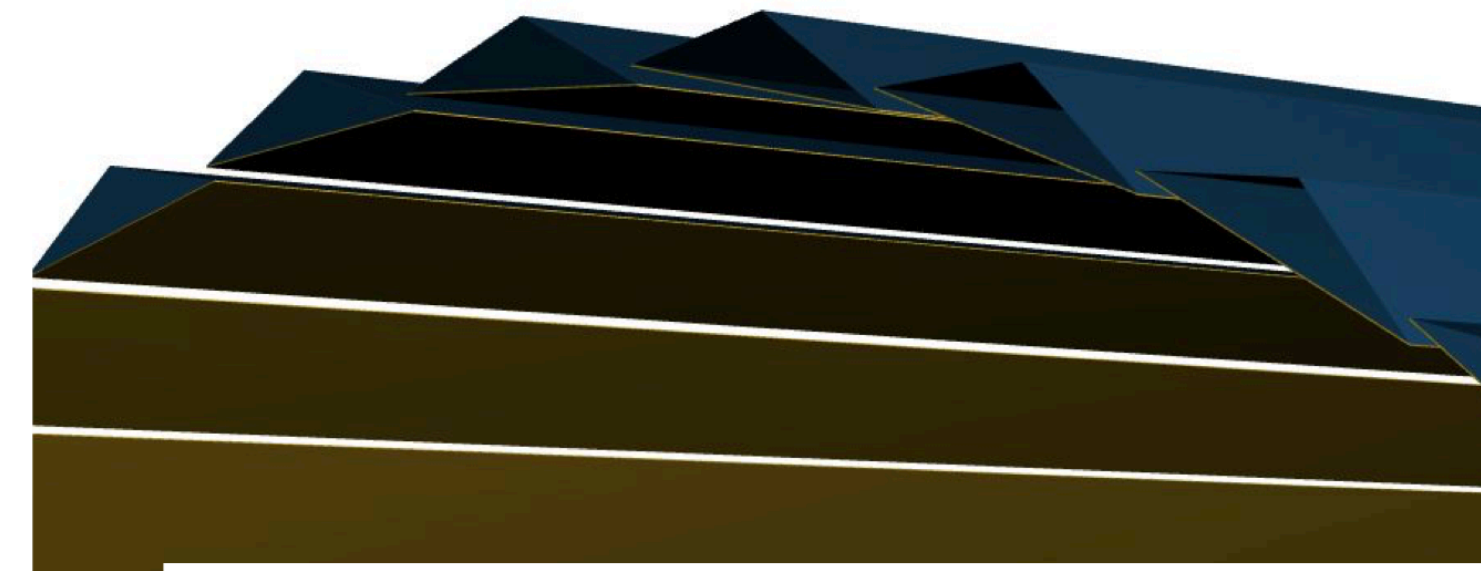

Stave concept is evolving — simulations need to follow and lead



# Tracking Workfest — Wednesday session

Shujie Li (LBNL)

## Disks

**In simulation:** use larger centered hole to accommodate beampipe fan-out

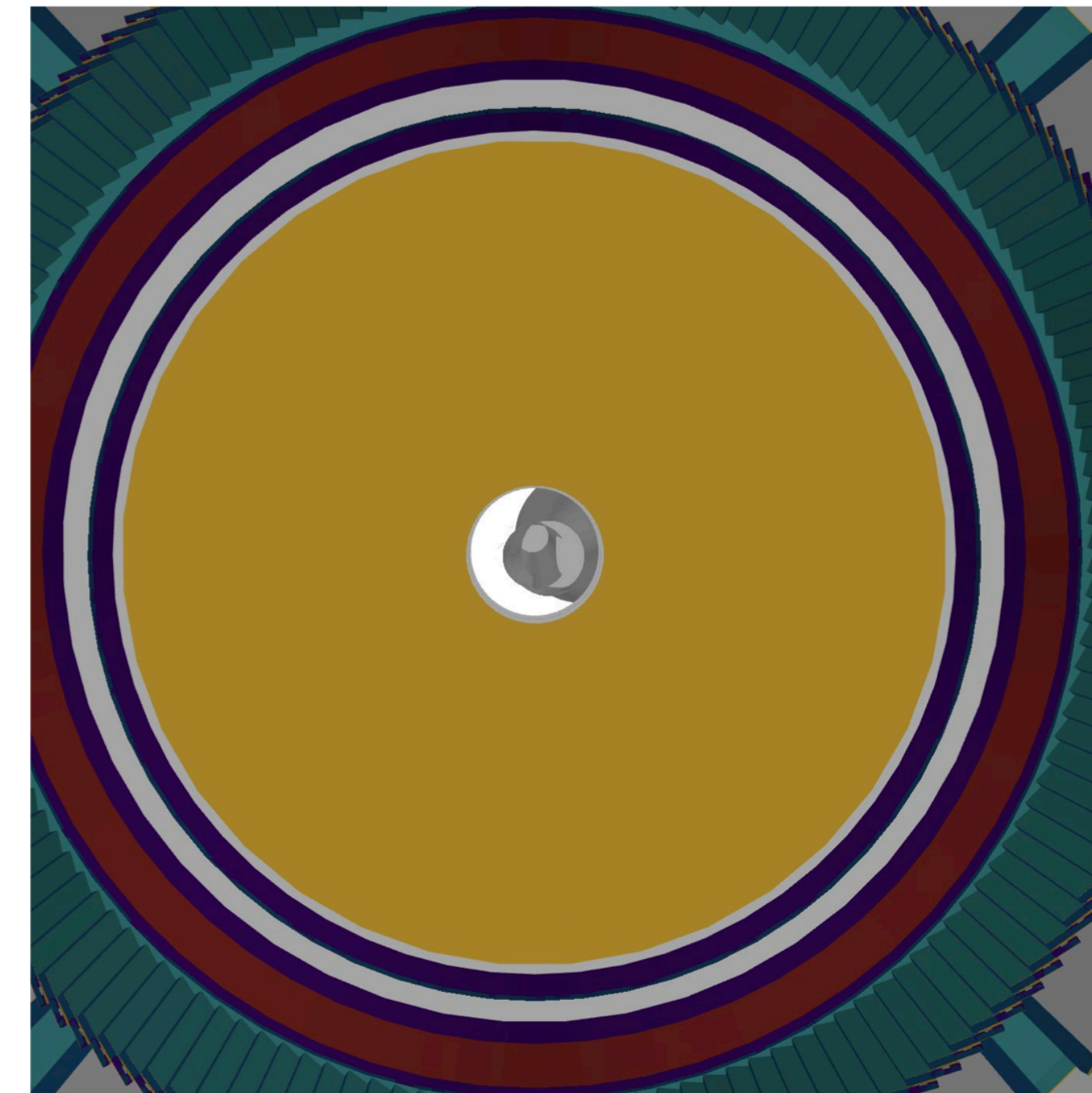
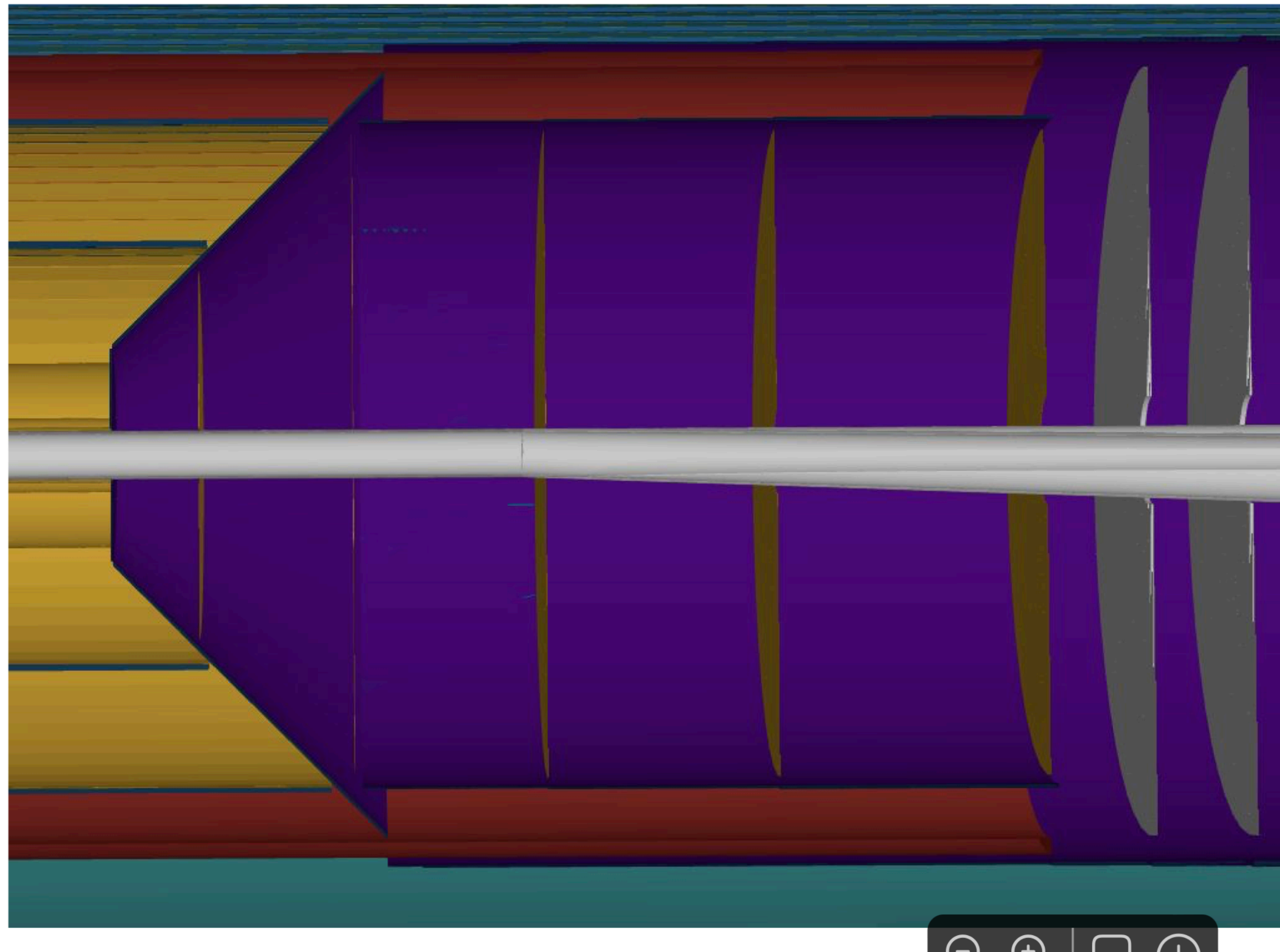

**Disk tiling and small angle acceptance are a wide open area — e.g. small-x physics**



# Tracking Workfest — Wednesday session

Shujie Li (LBNL)

## Disks

**In simulation:** use larger centered hole to accommodate beampipe fan-out

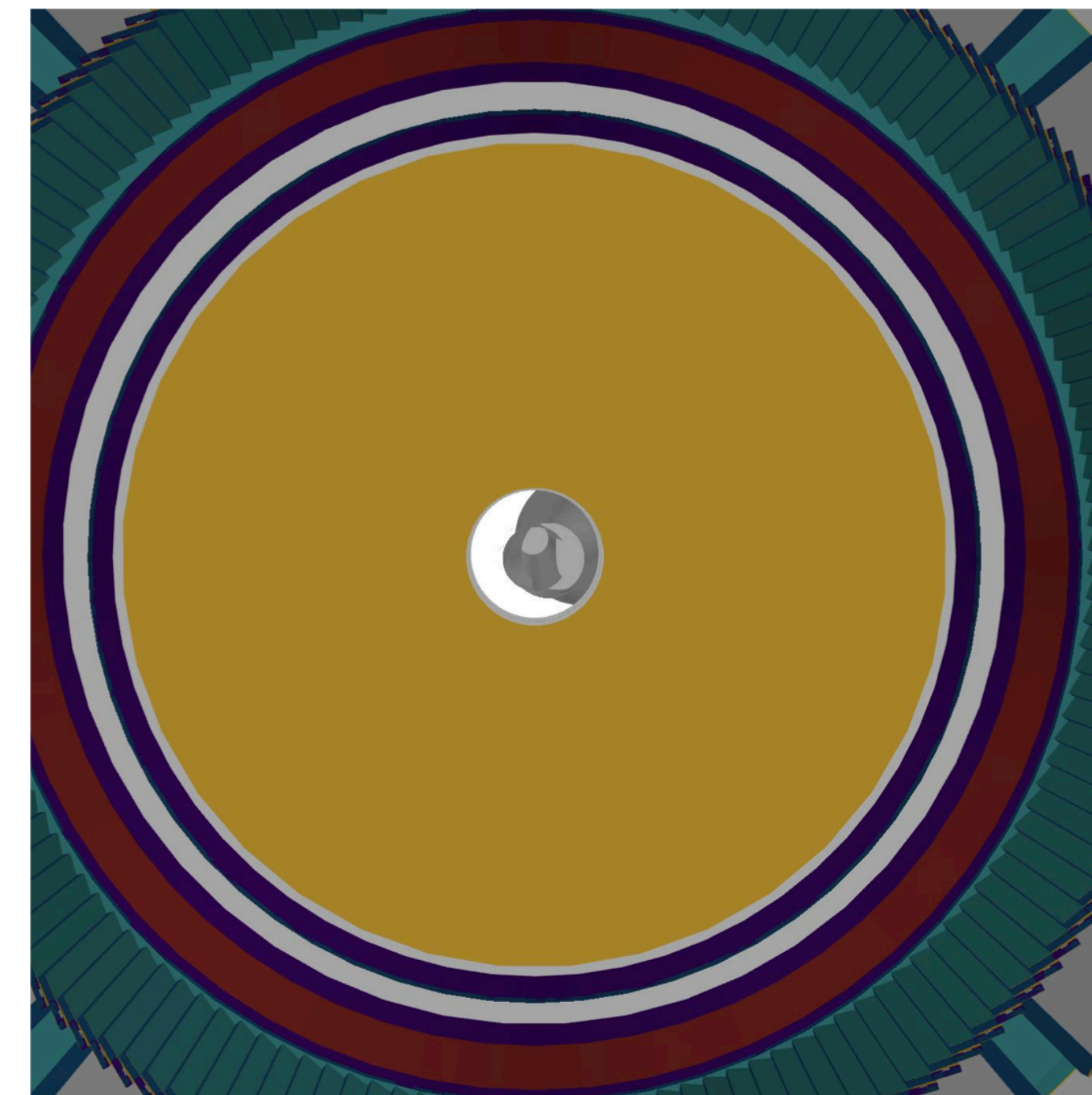
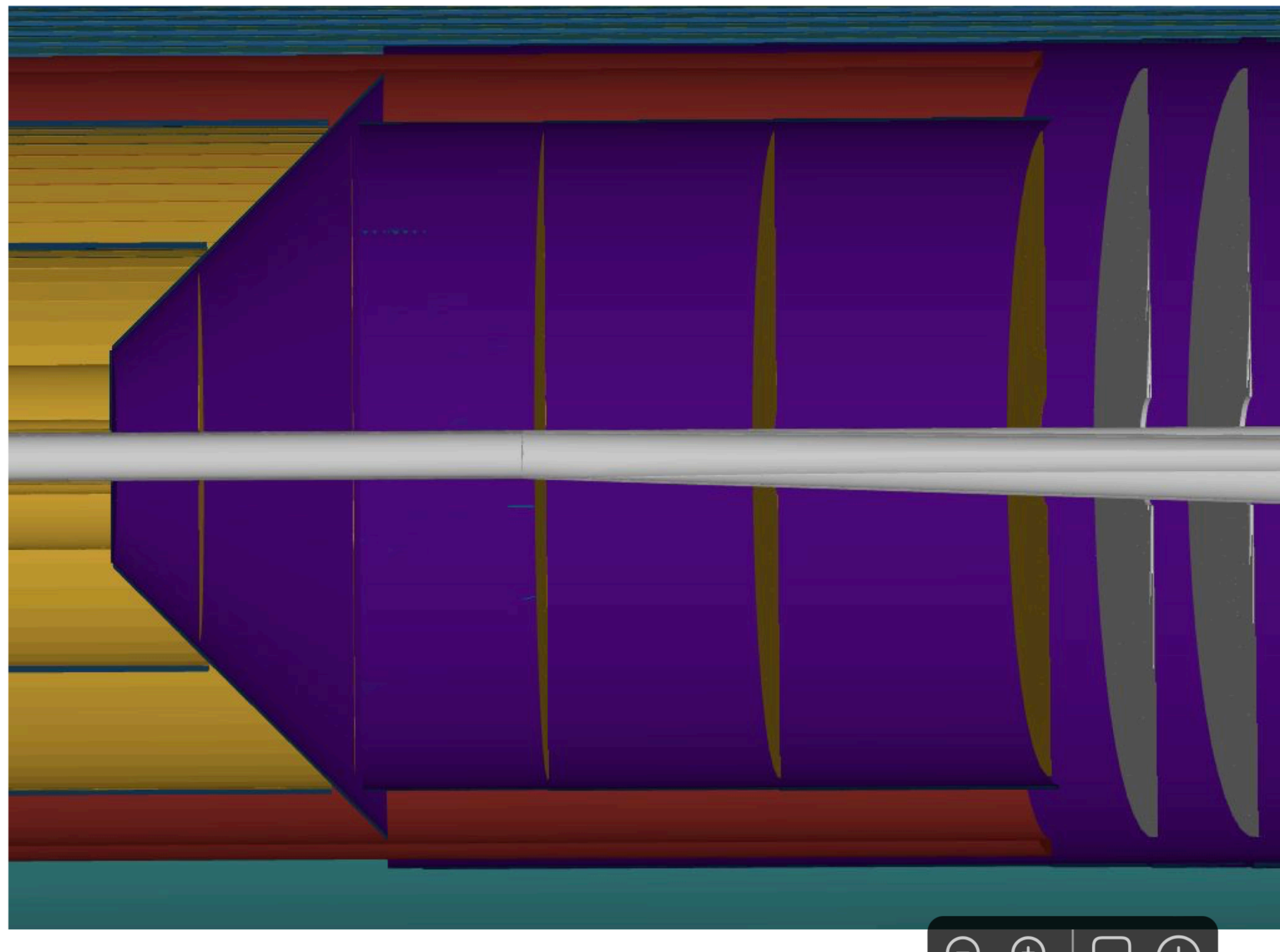

**Disk tiling and small angle acceptance are a wide open area — e.g. small-x physics**



# Tracking Workfest — Wednesday session

Matt Posik (Temple)

## ePIC MPGD Detectors

---

□ MPGD detectors based on two technologies:

- *μMegas* (curved layers)
  - **Cylindrical Micromegas Barrel Layer (CyMBaL)**
- *μRWELL* (planar layers)
  - **μRWELL Barrel Outer Tracker (μRWELL-BOT)**
  - **μRWELL EndCap Tracker (μRWELL-ECT)**

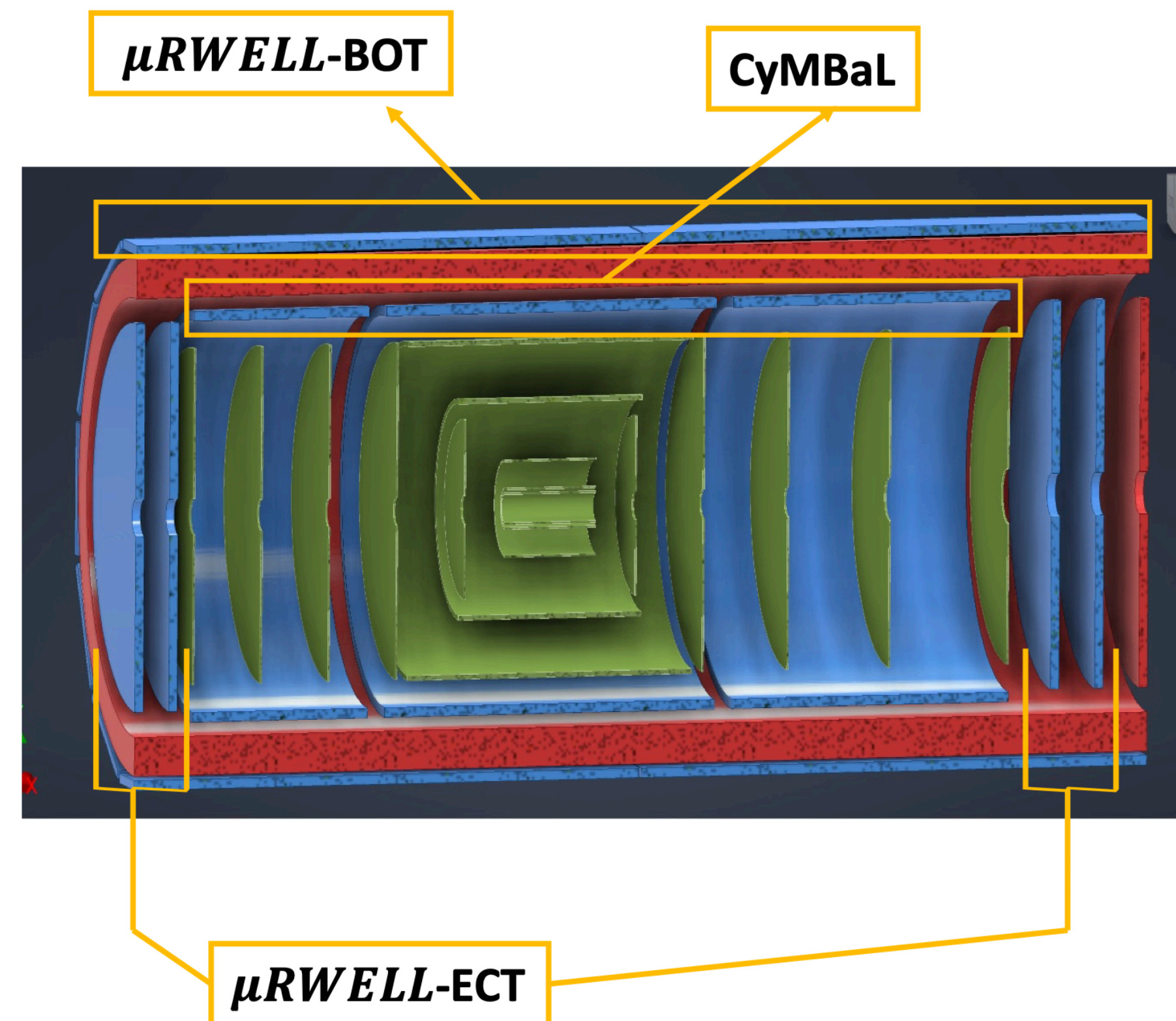

# Tracking Workfest — Wednesday session

Matt Posik (Temple)

## $\mu$ RWELL-BOT: Simulation Status

---

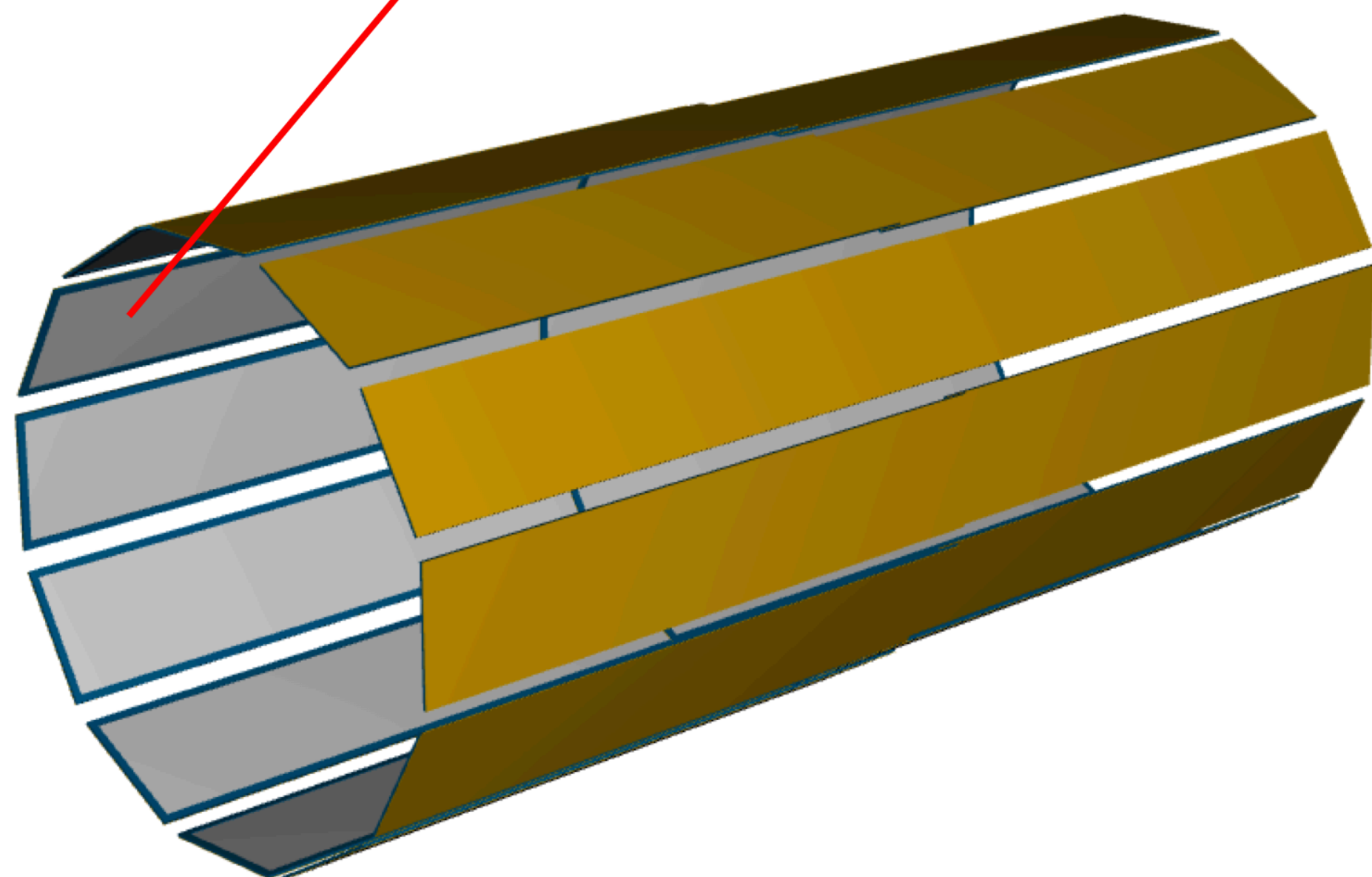
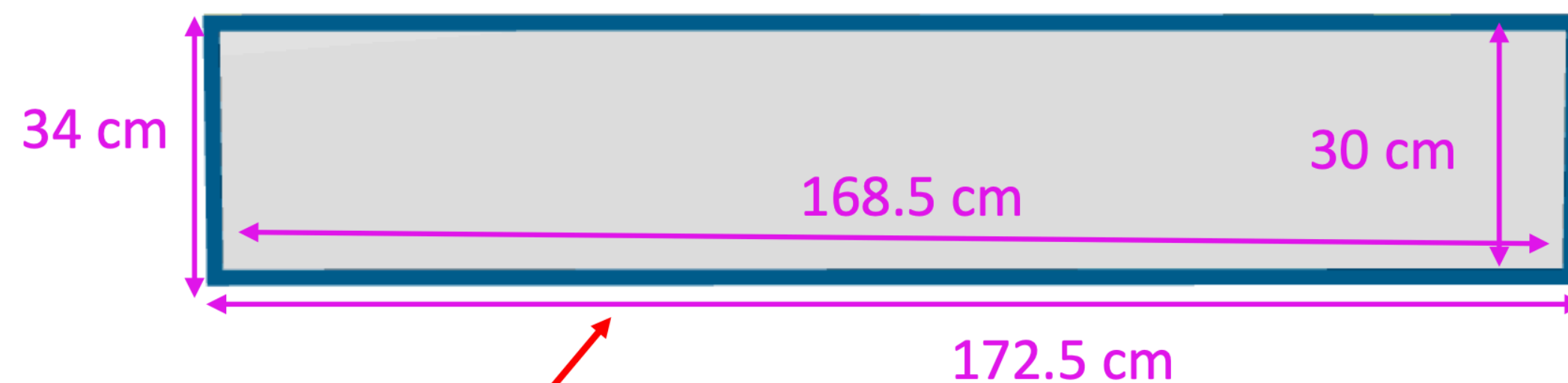

### Status

- Planar layers based on  $\mu$ RWELL technology
- Two panels needed for full length
- Panels arranged around azimuth
- Frame width = 20 mm, thickness = 7 mm
- Barrel:
  - $L = 339 \text{ cm}$  ( $-164.5 \text{ cm} \leq Z \leq 174.5 \text{ cm}$ )
  - $R = \sim 72.5 \text{ cm} / 73.5 \text{ cm}$
  - Overlap in  $R = 1.2 \text{ cm} / 2 = 6 \text{ mm}$

### Needed Work

- Remove overlap in adjacent modules
- Modify support frame
- Modify module geometry



# Tracking Workfest — Wednesday session

Sakib Rahman (Manitoba)

## Steps to Add a New Detector Element for ePIC Simulation

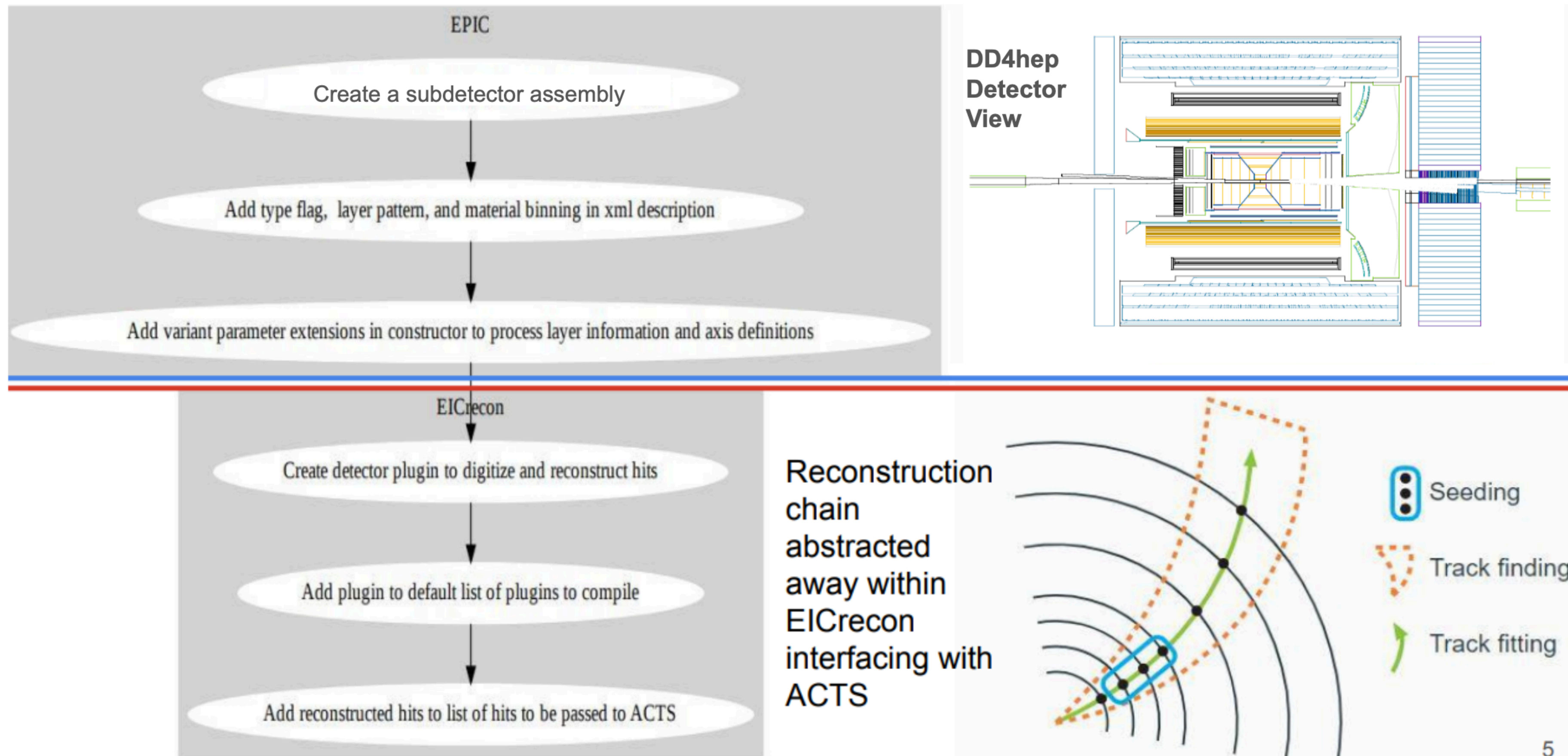

# Tracking Workfest — Wednesday session

Sylvester Joosten (ANL), Wouter Deconinck (Manitoba)



## BARREL IMAGING CALORIMETER (BIC)

### Addressing the unique challenges for the barrel region in ePIC

**Hybrid concept:** 4 (+2) layers of Astropix interleaved with the first 5 Pb/ScFi layers, followed by a large volume with the rest of the Pb/ScFi layers

- ✓ Deep calorimeter ( $\eta = 0 \sim 17.1 X_0$ ) while compact at  $\sim 40$  cm
- ✓ Excellent energy resolution ( $5.2\% \sqrt{E} \oplus 1.0\%$ )
- ✓ Unrivaled low-energy electron-pion separation by combining the energy measurement with shower imaging
- ✓ Unrivaled position resolution due to the silicon layers
- ✓ Deep enough to serve as inner HCal
- ✓ Very good low-energy performance
- ✓ Wealth of information enables new measurements, ideally suited for particle-flow
- ✓ Serves as tracking layer behind the DIRC

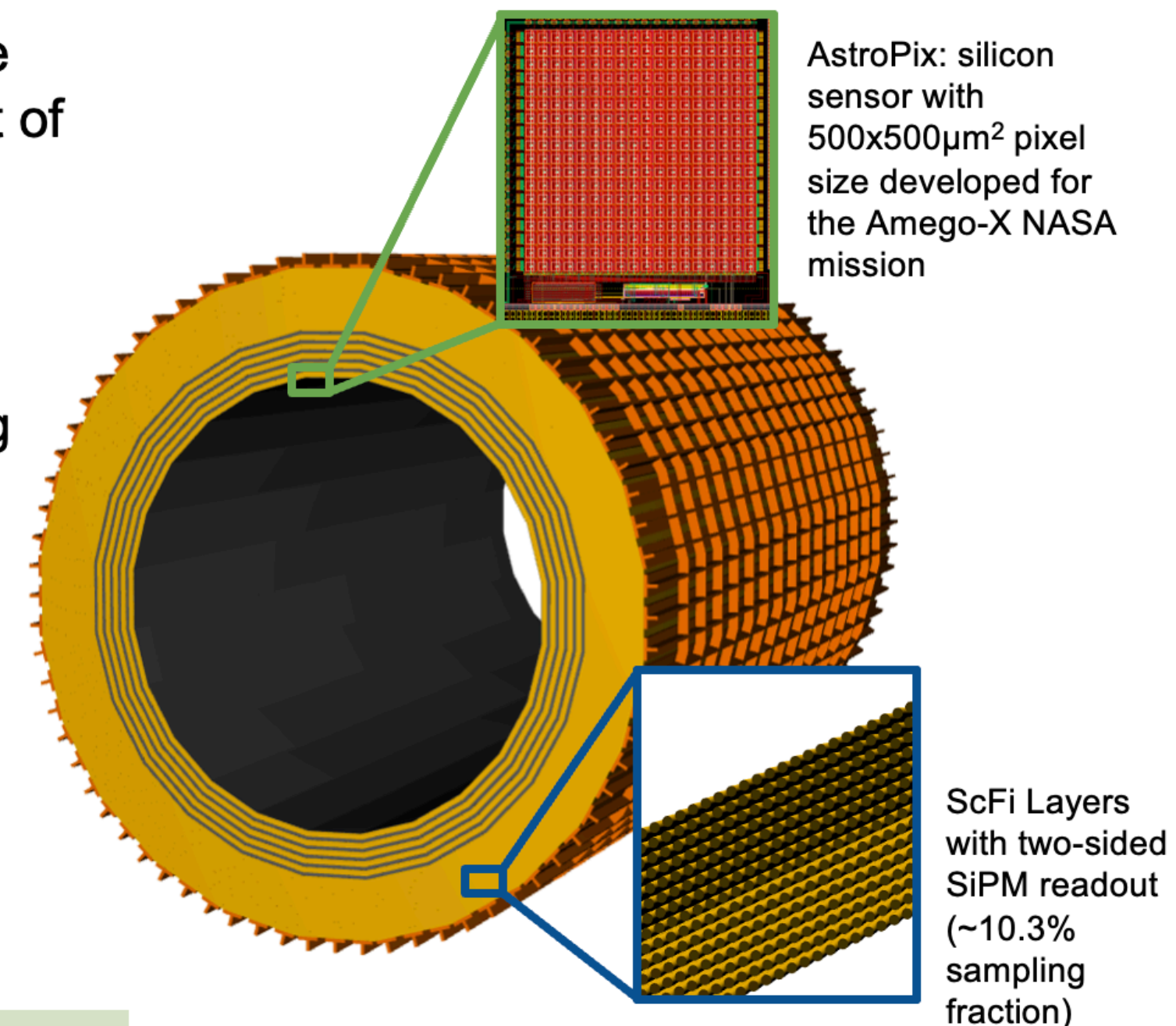

Checks all the boxes!

This work is supported by the U.S. Department of Energy, Office of Science, Office of Nuclear Physics, under contract DE-AC02-06CH11357.

except for the box integration of the tracking layer in reconstruction — workforce limited



Thank you to all who participated,  
and in particular also the local organization