

A history of the Ψ and its offspring

Martin Breidenbach

November 9 was the 50th
anniversary of the ψ discovery
and the beginning of the
November Revolution.

Unfortunately, a 50th anniversary is a rather long time, and many of the principals are gone. More at the end of this.

Following are my recollections of 1974 and the “November Revolution”.

In the early 70's

- Nucleons have point like constituents consistent with quark charge assignment and spin = $\frac{1}{2}$.
- QCD* explained the absence of free quarks.
- Asymptotic freedom explains scaling, but needs deviations from scaling (which will show up!)
- Bootstrap, nuclear democracy, vector meson dominance, diffraction models all fading away.
- QCD color fixed the Pauli principle problems.
- QCD gluons carry half nucleon momentum, rest by quarks.
- And SPEAR was beginning:

SPEAR - The first proposal - 1964 Led by Burton Richter

PROPOSAL

It is proposed that the Atomic Energy Commission support the construction at Stanford University of a Colliding-Beam Facility (storage ring) for high-energy electrons and positrons. This facility would be located at the Stanford Linear Accelerator Center, and it would make use of the SLAC accelerator as an injector.

This proposal was prepared by the following persons:

Stanford Physics Department

D. Ritson

Stanford Linear Accelerator Center

S. Berman
A. Boyarski
F. Bulos
E. L. Garwin
W. Kirk
B. Richter
M. Sands

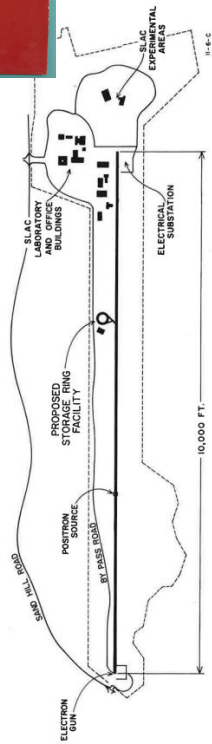
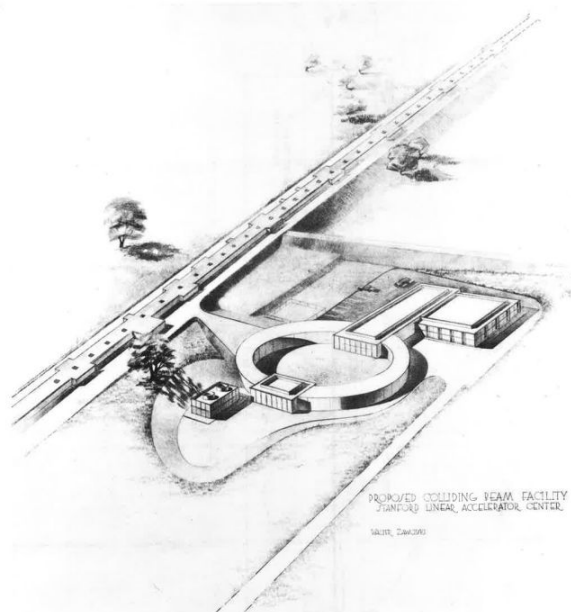

FIG. 12.-Location of the proposed storage-ring facility on the SLAC site.



SPEAR - The first proposal - 1964

PROPOSAL

It is proposed that the Atomic Energy Commission support the construction at Stanford University of a Colliding-Beam Facility (storage ring) for high-energy electrons and positrons. This facility would be located at the Stanford Linear Accelerator Center, and it would make use of the SLAC accelerator as an injector.

This proposal was prepared by the following persons:

Stanford Physics Department

D. Ritson

Stanford Linear Accelerator Center

S. Berman

A. Boyarski

F. Bulos

E. L. Garwin

W. Kirk

B. Richter

M. Sands

8 Authors

2/3 down the linac

Relatively luxurious

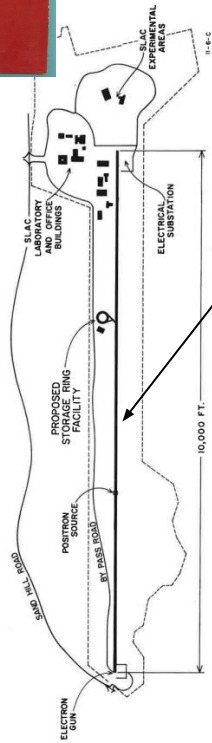
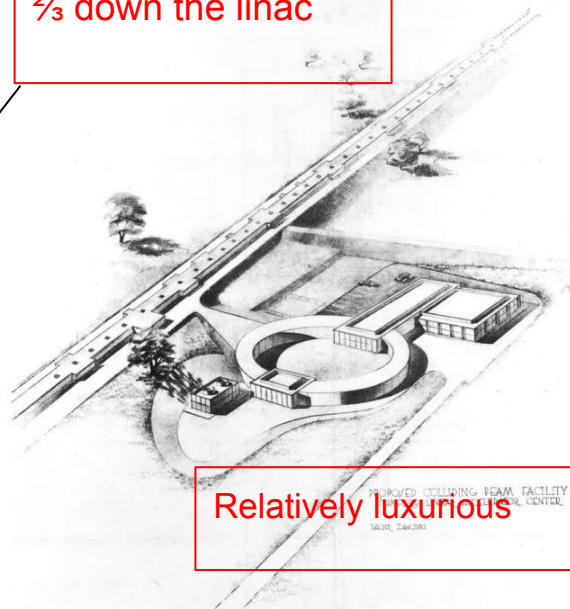
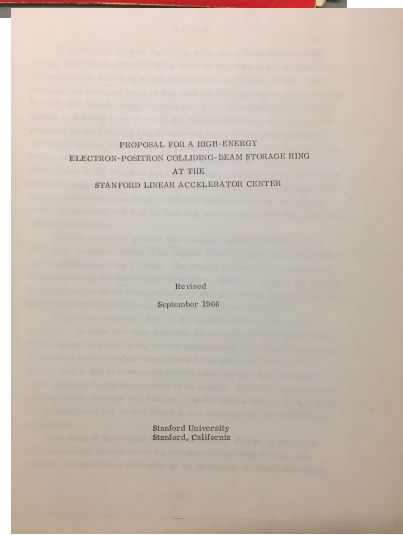
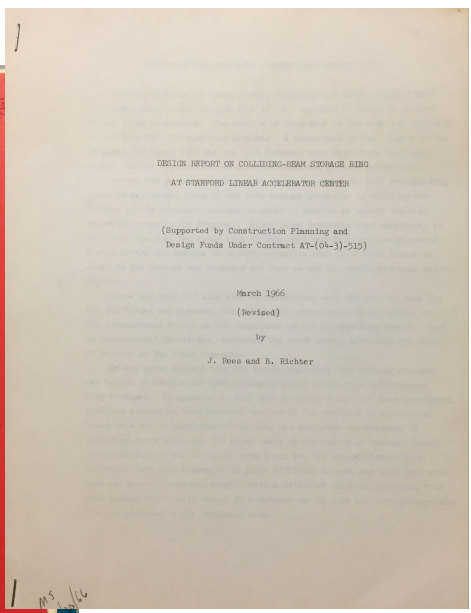
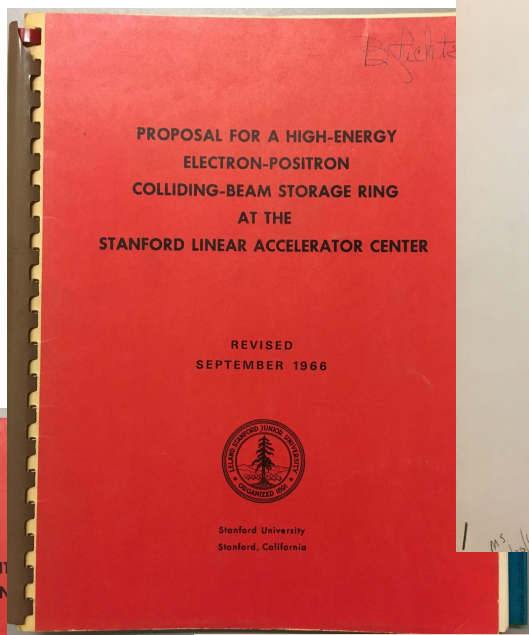
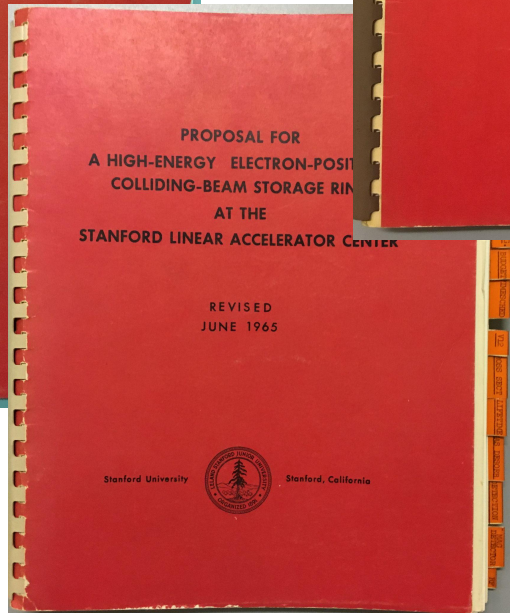
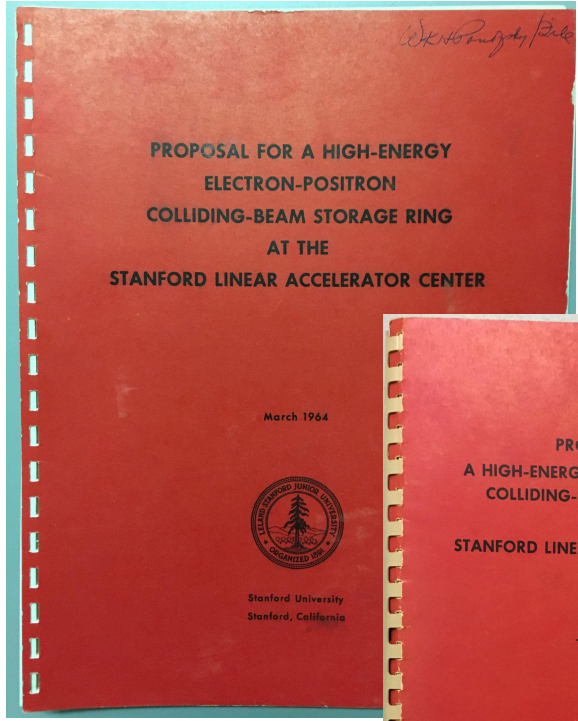

FIG. 12--Location of the proposed storage-ring facility on the SLAC site.



More proposals



+ Escalated cost estimates in 67 and 68. Late 69, the Controller of the AEC, John P. Abadessa, agrees SPEAR could be built with Equipment money

The Spear Schedule

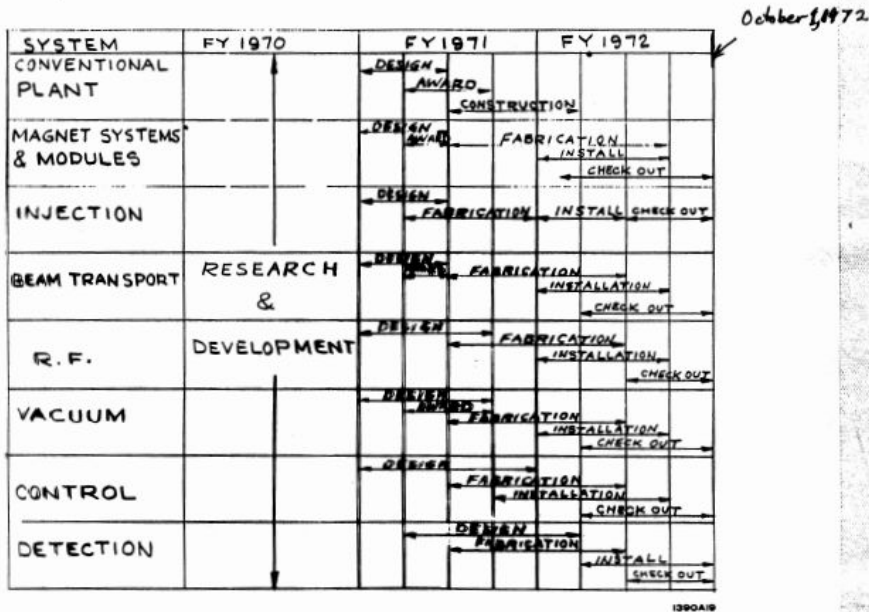

5. CONSTRUCTION

- (a) Originally we thought it would take about two years to build, but we found that we were spending money too fast, so we did what any alert project managers would do: we shortened the schedule.

From John Rees - The Genesis of Spear 1990(?)

SPEAR, before SSRP and SSRL, was a parking area

End Station A, deep
inelastic scattering,
pointlike structure in
nucleons

Injection lines

West Pit, enclosing SLAC-LBL
Magnetic Detector



SPEAR, 780 ns around
Power Supplies
Control Room, SPEAR
and Detector

SPEAR, ~1973

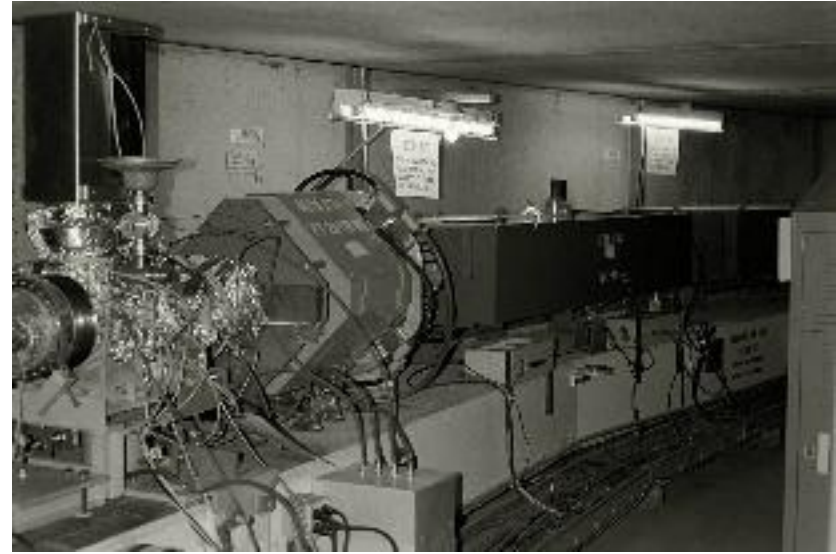

SPEAR was approved after a long struggle.
Built for \$6M, with operations commencing
21 months after approval.

The SLAC-LBL Magnetic Detector (aka MK-I)



Vera Luth

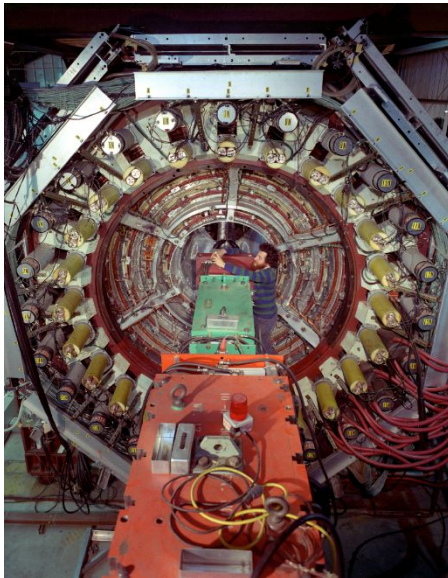

Carl Friedberg

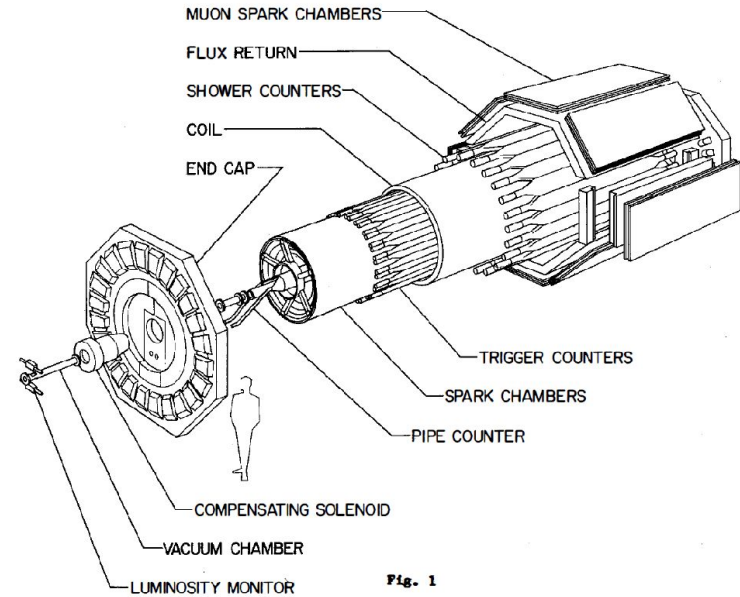

The first of the $\sim 4\pi$, cylindrical, electronic detectors with tracking in an axial B field, conceived by Burton Richter. Built by a large collaboration (for the time) of 35 people.

Critically different from the spectrometers at, e.g. the CERN Intersecting Storage Rings (ISR)

Ready for data in February 1973

BNL 22 November 2024

The detector

- MK-I was the first to break from measuring inclusive reactions with relatively small acceptance spectrometers. It had a new combination of large acceptance and μ -sec time resolution.
- MK-I was $\sim 4\pi$, cylindrically symmetric with an axial B field.
 \sim all collider detectors have followed this model.
- It was enabled by a tracker technology suitable for low mass cylindrical layout: small angle stereo wire spark chambers - read out electronically with magnetostrictive delay lines. $\Delta P/P \sim 2\%$ for $P = 1 \text{ GeV}/c$



MK-I

- All other subsystems were scintillator viewed by PMT's.
- The electronics scale would have been very difficult with discrete transistors, but was a reasonable match to small scale Integrated Circuits. (Long before ASIC's)

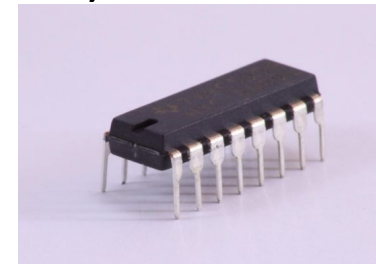

- The scale of the detector was so large that Richter recruited Perl's group from SLAC and the Goldhaber-Trilling group from LBL for a total of 35 people.

By modern standards, MK-I was rather small...

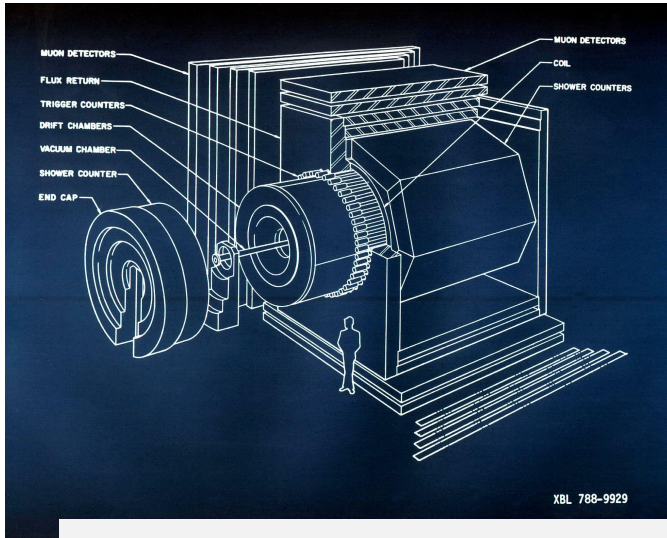

MK-I
~4 m long, ~4 m diameter, ~170 tonnes

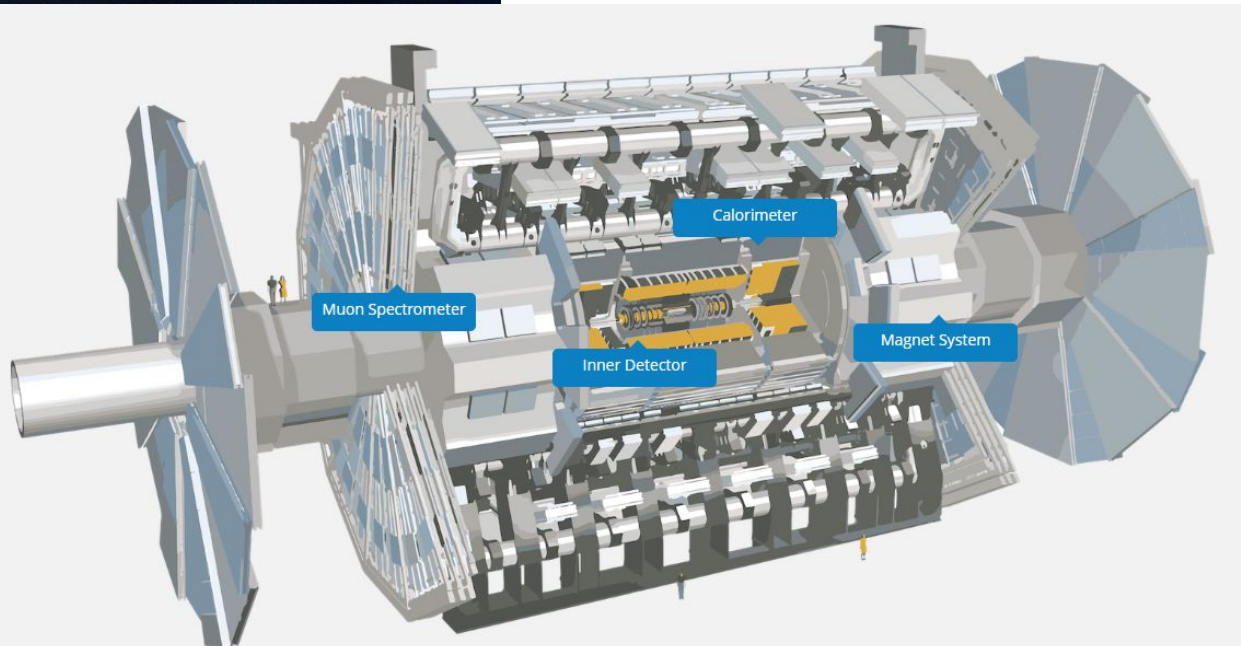

ATLAS
46 m long, 25 m diameter, 7000 tonnes

SPEAR in 1973 - 1974

- We were working on an overdue paper on $R = \sigma_h / \sigma_{\mu\mu}$ vs \sqrt{S}
- $R = \sum_i q_i^2$ was strangely large in results from ADONE and the CEA, hinting at colored quarks.



- “Accepted Wisdom” was that resonances were unlikely, but if something was there it would be several hundred MeV wide and with an R increase of a few.
- At SPEAR, in 1973, we measured R from 2.4 to 4.8 GeV in 200 MeV steps, and the runs at 3.2 and 4.2 GeV seemed high. In June of 1974, we re-measured 3.1, 3.2, and 3.3 GeV- and 4.1, 4.2. and 4.3 GeV just before the summer shutdown. I did a quick analysis and left the logbook note “ The Whiz-Bang Analysis Team says there is no bump at 4.2 Gev”.

1974

- Several of us, led by Roy Schwitters, looked harder at the data around 3.1 GeV, and found that runs at the same nominal energy had statistically inconsistent values of R . Suspecting software, we went to the first video display at SLAC connected to the mainframe (a huge monstrosity that had to be reserved in advance), and we classified event pictures and made tallies by hand. Nothing could be found wrong with the analysis.
- That summer, SPEAR was upgraded to SPEAR 2, and planned to run above 5 GeV. Roy, Ewan Paterson, and I argued with Richter to go back to 3.1 GeV. Burton argued that it was more interesting to move forward into new territory. That Friday, Gerson Goldhaber reported (incorrectly as it turned out) that the high σ runs at 3.1 had an excess of K_s . We were given the weekend “to waste”.

The Control Room Scene



The epicenter of the Control Room.



Reel to reel tape drives.
Reels mounted by hands!
140 Mbytes/Reel

BNL 22 November 2024



A modern version of the Teletype, but still an important human interface

SPEAR Beam Energy

Checking the machine Energy

$$\frac{\Delta E}{E_0} = \frac{\Delta B}{B_0} + \left(\frac{\Delta E}{E_0} \right)_{\text{ORBIT}}$$

$$\left(\frac{\Delta E}{E_0} \right)_{\text{ORBIT}} = \frac{1}{16 \times 280} \left[2(M_3 + M_{10} + M_{15} + M_{22}) + \sum_4^9 M_i + \sum_{16}^{21} M_i \right]$$

(cm)

The RF frequency does not explicitly appear in the expression for the energy shift; a change in freq. at fixed B will result in orbit changes. For fixed B and allowing orbits to change

$$\left(\frac{\Delta E}{E_0} \right)_{\text{RF}} = \frac{-1}{.042} \frac{\Delta f}{f_0}$$

The above is only a super fine tuning control; the least count of the magnet setting is ~ 2 mev.

NOTE: the machine has a natural energy spread $\frac{\sigma}{E_0} \approx 0.0004$

The SPEAR bend magnets, and thus beam orbit – set the beam energy. The DAC that set the magnet current was too coarse, and one bit stepped over the resonance. We realized that changing the RF frequency slightly would change the beam radius, and could Vernier the energy.

Sunday

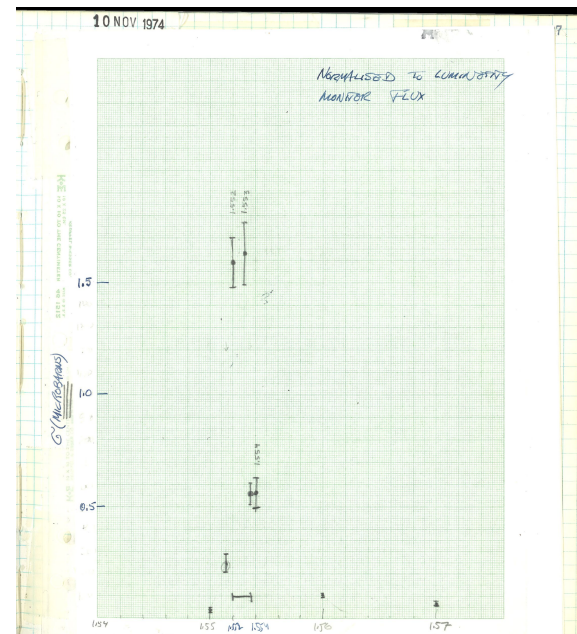
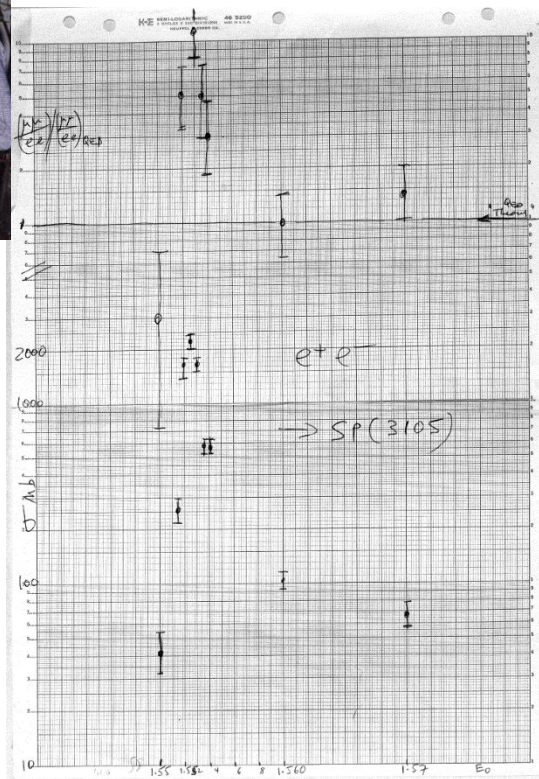
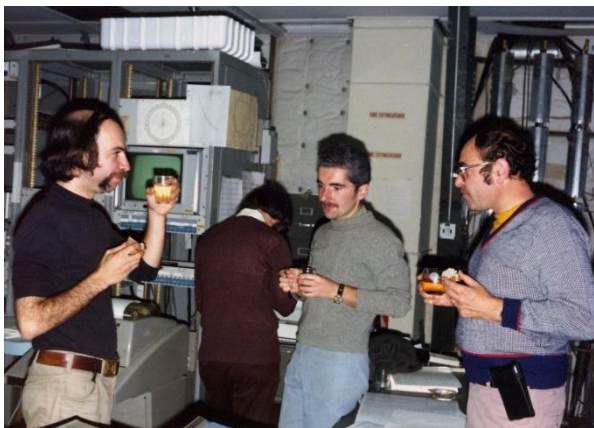

Monday

Discovery of a Narrow Resonance in e^+e^- Annihilation*

J.-E. Augustin,† A. M. Boyarski, M. Breidenbach, F. Bulos, J. T. Dakin, G. J. Feldman, G. E. Fischer, D. Fryberger, G. Hanson, B. Jean-Marie,† R. R. Larsen, V. Lüth, H. L. Lynch, D. Lyon, C. C. Morehouse, J. M. Paterson, M. L. Perl, B. Richter, P. Rapidis, R. F. Schwitters, W. M. Tanenbaum, and F. Vannucci‡

Stanford Linear Accelerator Center, Stanford University, Stanford, California 94305

and

G. S. Abrams, D. Briggs, W. Chinowsky, C. E. Friedberg, G. Goldhaber, R. J. Hollebeek, J. A. Kadyk, B. Lulu, F. Pierre,§ G. H. Trilling, J. S. Whitaker, J. Wiss, and J. E. Zipse

Lawrence Berkeley Laboratory and Department of Physics, University of California, Berkeley, California 94720
(Received 13 November 1974)

We have observed a very sharp peak in the cross section for $e^+e^- \rightarrow \text{hadrons}$, e^+e^- , and possibly $\mu^+\mu^-$ at a center-of-mass energy of 3.105 ± 0.003 GeV. The upper limit to the full width at half-maximum is 1.3 MeV.

We have observed a very sharp peak in the cross section for $e^+e^- \rightarrow \text{hadrons}$, e^+e^- , and possibly $\mu^+\mu^-$ in the Stanford Linear Accelerator Center (SLAC)–Lawrence Berkeley Laboratory magnetic detector¹ at the SLAC electron-positron storage ring SPEAR. The resonance has the parameters

$$E = 3.105 \pm 0.003 \text{ GeV,}$$

$$\Gamma \leq 1.3 \text{ MeV}$$

(full width at half-maximum), where the uncertainty in the energy of the resonance reflects the

uncertainty in the absolute energy calibration of the storage ring. [We suggest naming this structure $\psi(3105)$.] The cross section for hadron production at the peak of the resonance is ≥ 2300 nb, an enhancement of about 100 times the cross section outside the resonance. The large mass, large cross section, and narrow width of this structure are entirely unexpected.

Our attention was first drawn to the possibility of structure in the $e^+e^- \rightarrow \text{hadron}$ cross section during a scan of the cross section carried out in 200-MeV steps. A 30% (6 nb) enhancement was

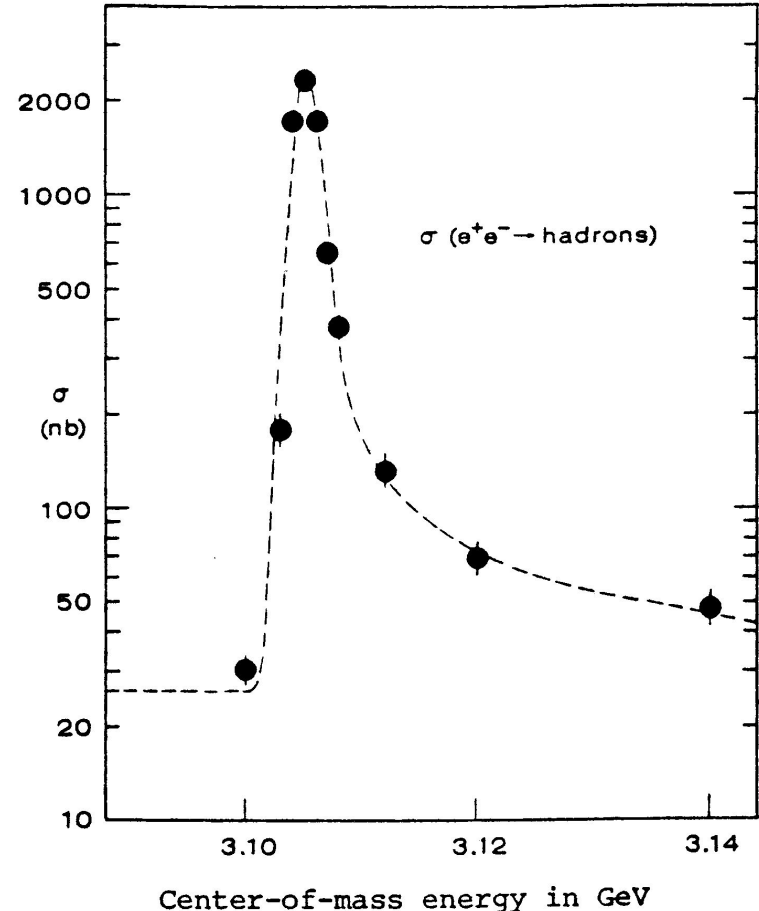

3 PRL's published on 2
December – SLAC, BNL, and
ADONE.

Visible width dominated by SPEAR energy spread. True width extracted from Breit-Wigner shape : $\Gamma = 91.0 \pm 3.2$ keV (later result)

The J

Remarkably, Sam Ting was at SLAC that Monday for a meeting of the SLAC PAC. Roy, Vera, and I were in a tiny conference room editing the latest draft of the PRL, when Pief summoned Roy to his office. Roy returned, white as a sheet, and announced that “Sam has the same thing”. A joint seminar by Roy and Sam was held that afternoon.

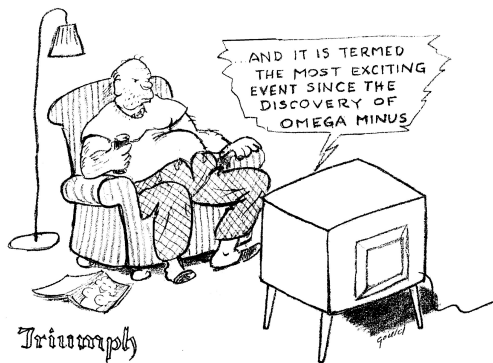

Next Week

The obvious question was were there more narrow resonances. Bob Melen changed the DAC and SPEAR controls so that the energy could be controlled in fine steps, and Len Shustek and I invented a way to turn the IBM mainframe into a useful realtime computer.

Terry Goldman and I concocted a positronium model of the ψ , and predicted 3.7 GeV for the ${}_2S$ state, so a little below that is where we started the scan.

Thursday - 21 November

SPEAR was stepped in increments of ~ 1 MeV for 3 minute runs, analyzed in \sim realtime and plotted. Very late that evening...

Brief consideration of going for the ψ'' that night – but decided to rescan the ψ'

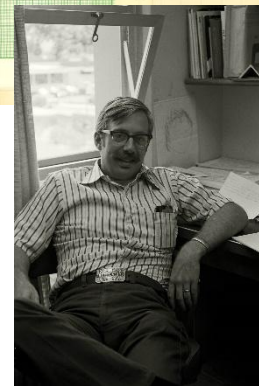
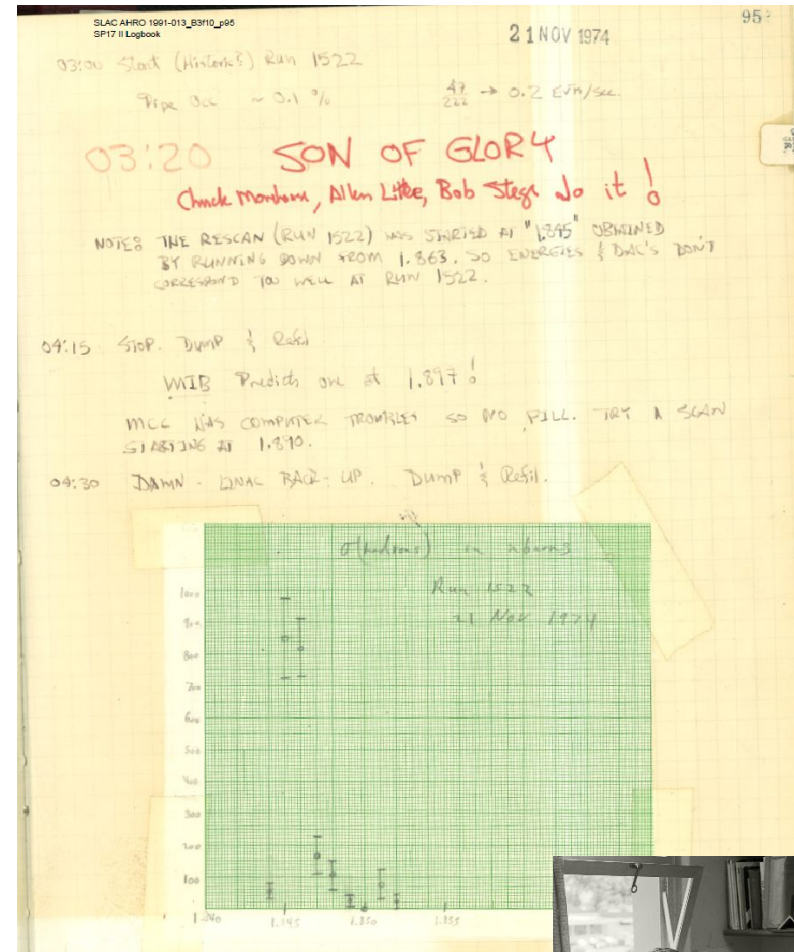

SPEAR- Mk-1 scanning

~ 3 minutes/point

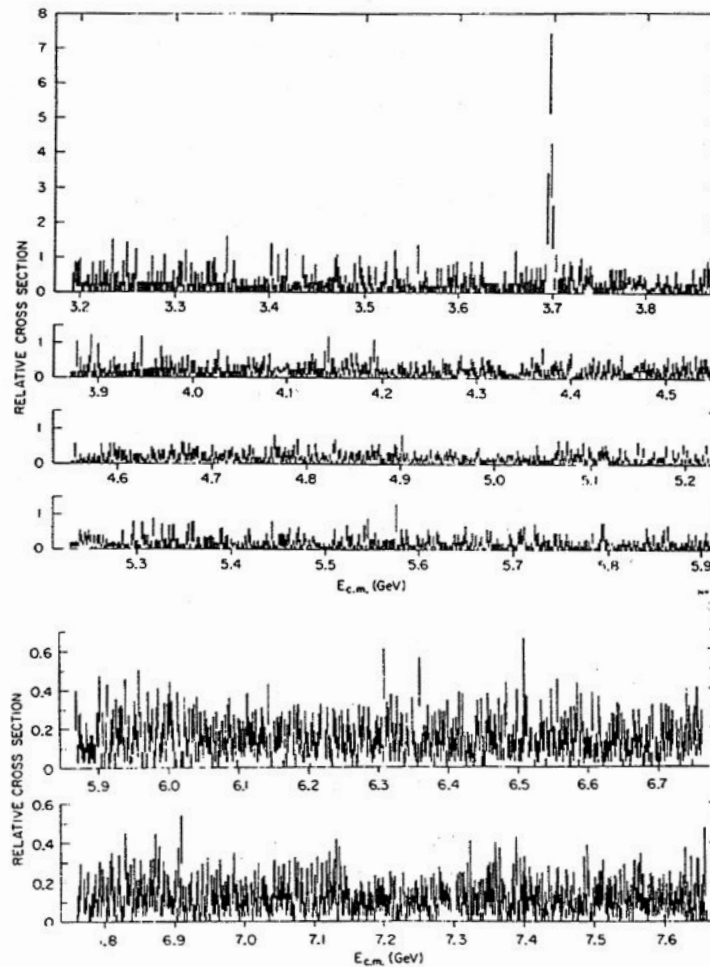

XBL 8411-6310

Ψ' Announcement to \sim world

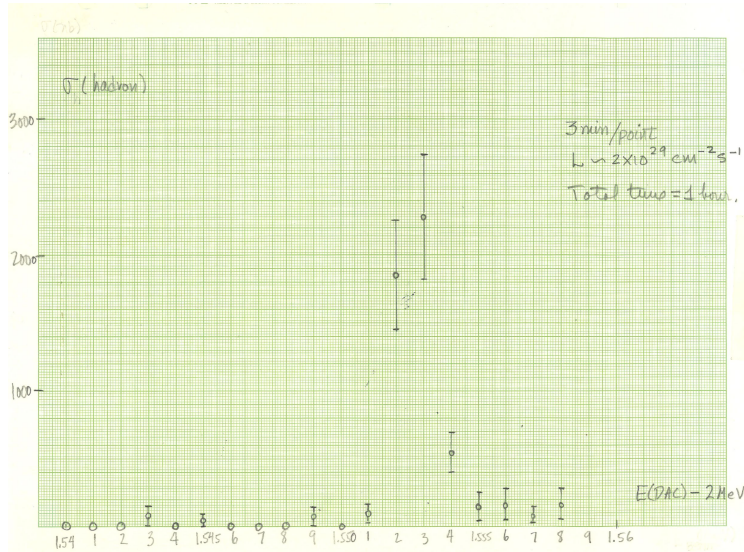

Called Pief \sim 5:00 AM, Adele says he is taking a bath – should she get him?

SLAC computing preempts everything.

```

? ***
FROM OPB (OPERATOR): (MIDDEC83) REALTIME ANALYSIS OF RUN 1530 BEGINNING
? ***
FROM OPB (OPERATOR): (MIDDEC83) 1 E=1.547 SIG= 4.05E 02+- 6.19E 01
? ***
FROM OPB (OPERATOR): (MIDDEC83) REALTIME ANALYSIS OF RUN 1530 ENDING
? ***
DUE TO NEW PARTICLE DISCOVERY..THE SYS. WAS NOT TAKEN DOWN THIS AM
$H*112r7H24C0CnFJDA8DBZYI*J1Cn18X n1c0*ms0vL
SLAC MSG LINE 25 09:46:41 11/21/74
DUE TO NEW PARTICLE DISCOVERY..SYS. WAS NOT TAKEN DOWN THIS AM
TERMINAL? 895 H13 EC
KEYWORD? 000
ACTIVE SAVED BY RECOVERY LAST SESSION
?
    
```

Discovery of a Second Narrow Resonance in e^+e^- Annihilation*†

G. S. Abrams, D. Briggs, W. Chinowsky, C. E. Friedberg, G. Goldhaber, R. J. Hollebeek, J. A. Kadyk, A. Litke, B. Lulu, F. Pierre, †B. Sadoulet, G. H. Trilling, J. S. Whitaker, J. Wiss, and J. E. Zipse

Lawrence Berkeley Laboratory and Department of Physics, University of California, Berkeley, California 94720 and

J.-E. Augustin, § A. M. Boyarski, M. Breidenbach, F. Bulos, G. J. Feldman, G. E. Fischer, D. Fryberger, G. Hanson, B. Jean-Marie, § R. R. Larsen, V. Luth, H. L. Lynch, D. Lyon, C. C. Morehouse, J. M. Paterson, M. L. Peri, B. Richter, P. Rapidis, R. F. Schwitters, W. Tanenbaum, and F. Vannucci||

Stanford Linear Accelerator Center, Stanford University, Stanford, California 94305 (Received 25 November 1974)

We have observed a second sharp peak in the cross section for $e^+e^- \rightarrow$ hadrons at a center-of-mass energy of 3.695 ± 0.004 GeV. The upper limit of the full width at half-maximum is 2.7 MeV.

The recent discovery of a very narrow resonant state coupled to leptons and hadrons^{1,2} has raised the obvious question of the existence of other narrow resonances also coupled to leptons and hadrons. We therefore began a systematic search of the mass region accessible with the Stanford Linear Accelerator Center (SLAC) e^+e^- storage ring SPEAR and quickly found a second

[full width at half-maximum (FWHM)], where the mass uncertainty reflects the uncertainty in the absolute energy calibration of the storage ring.

The $\psi(3695)$, like the $\psi(3105)$, was found using the SLAC-Lawrence Berkeley Laboratory magnetic detector at SPEAR.⁴ The luminosity monitoring, event acceptance criteria, and storage-ring energy determination have been described

Ψ' – 2S Charmonium State

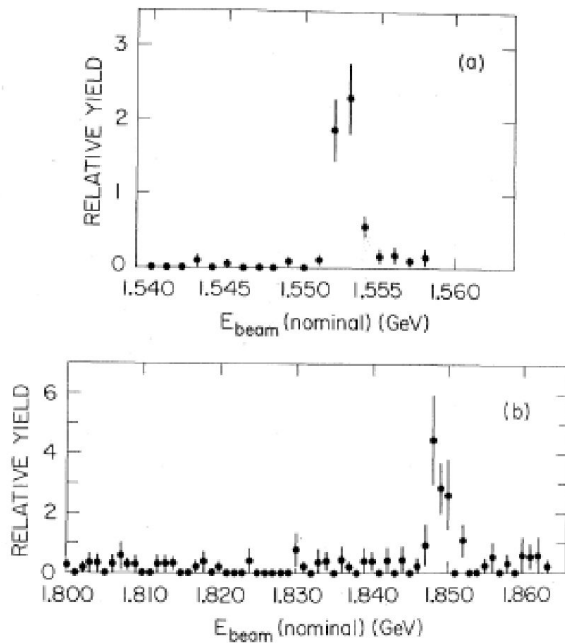

Top – checkout scan over the Ψ . Below – the Thursday night scan cleaned up.

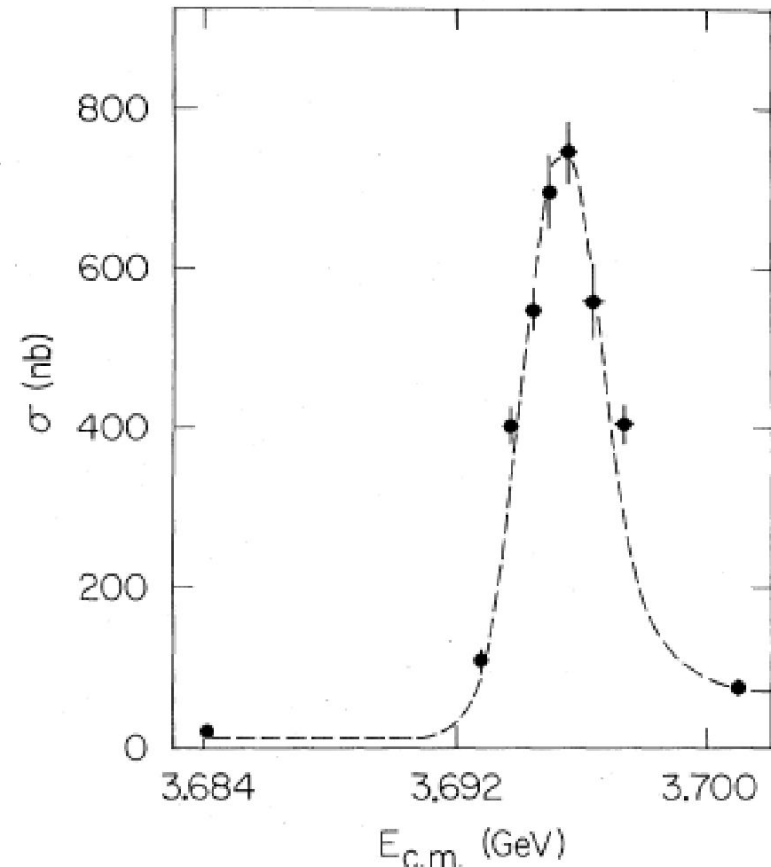

Higher resolution scan over the Ψ' . $\Gamma = 277 \pm 22 \text{ KeV}$ (later result)

Charm

- The following year was a non-stop procession of Charmonium spectroscopy and charmed mesons.

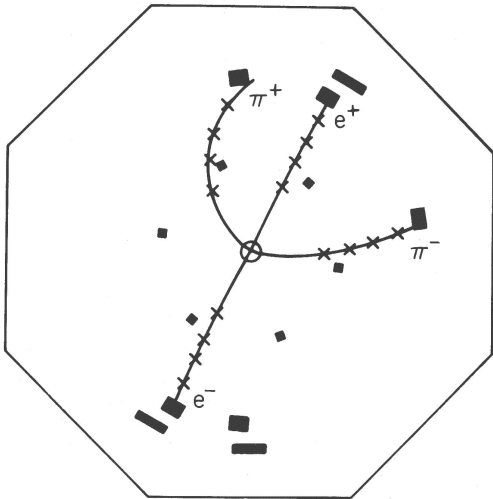

Ψ' self identification decay!

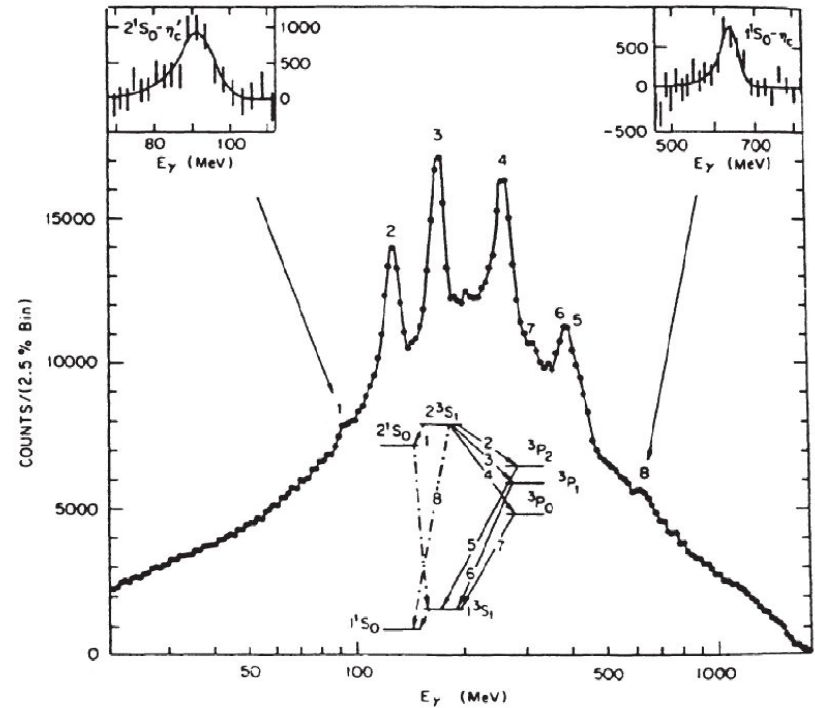

Radiative Transitions

e^+e^- can go directly only to states with same $J^{PC}=1^{--}$: $\psi, \psi', \psi(3770)$
 Other states from radiative decays, e.g.
 $e^+e^- \rightarrow \psi' \rightarrow \gamma + X$

Crystal Ball at SPEAR, E.D. Bloom et al



Charmed Neutral Mesons - 1976

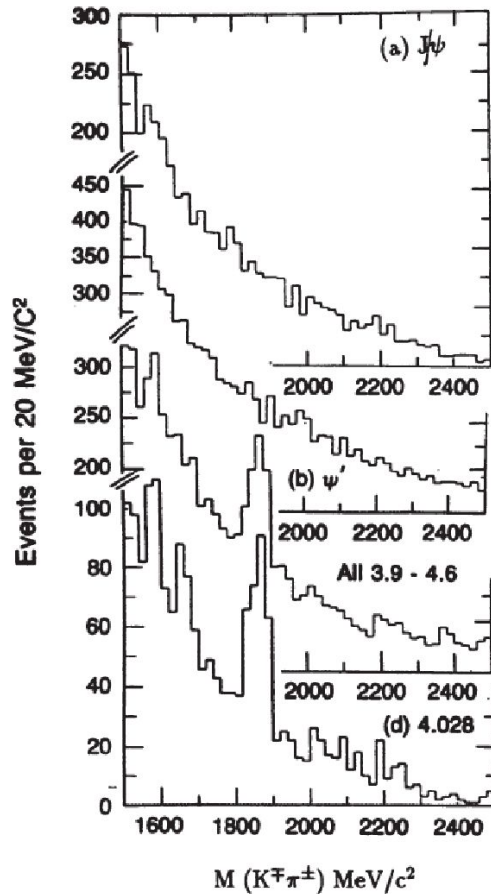

$D^0(1865)$ produced above threshold
of ~ 3.7 GeV

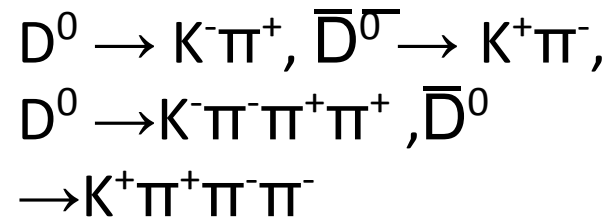
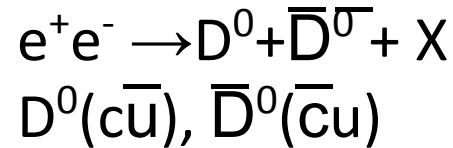

G. Goldhaber

F. Pierre

BNL 22 November 2024



Charmed Charged Mesons - 1976

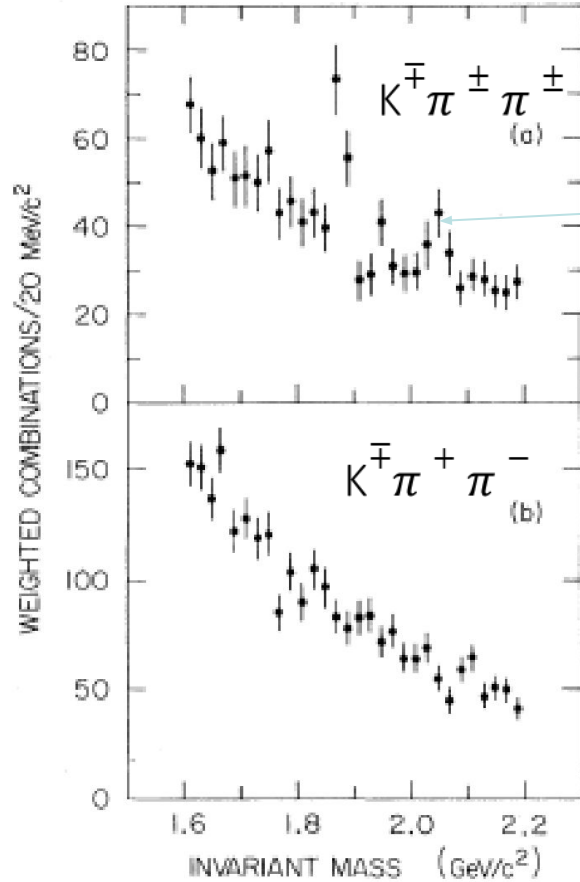

$$e^{+}e^{-} \rightarrow D^{+}D^{-} + X$$

$$D^{+} \rightarrow K^{-}\pi^{+}\pi^{+}, D^{-} \rightarrow K^{+}\pi^{-}\pi^{-}$$

$$D^{*+} \rightarrow D^{0}\pi^{+}$$

$$D^{+}(c\bar{d}), D^{-}(\bar{c}d)$$

$$M=1876\pm 15$$

I. Peruzzi, M. Piccolo et al

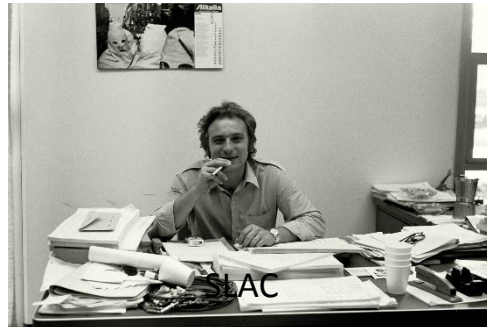

Jets in e^+e^- Annihilation

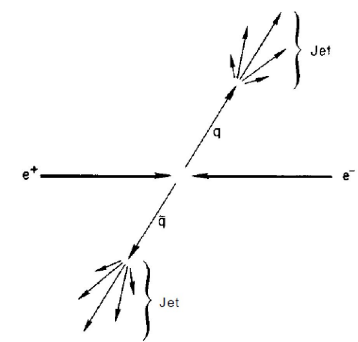

- Annihilation initial product could be e^+e^- , or $\mu^+\mu^-$, or $q\bar{q}$
- $q\bar{q}$, as they move apart, create a train of more $q\bar{q}$ pairs that combine to form hadrons, and conservation of momentum from the back to back initial pair leads to opposing jets.
- In early 1975, Gail Hanson found strong evidence for jet structure at SPEAR II, and that angular distribution of the jet axis required spin $\frac{1}{2}$ partons.

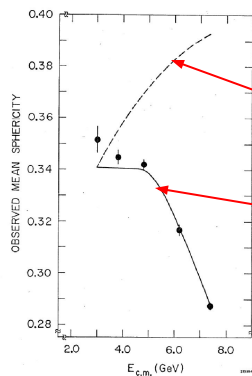

- Phase Space
- Jet Model $\langle P \rangle = 315$ MeV/c

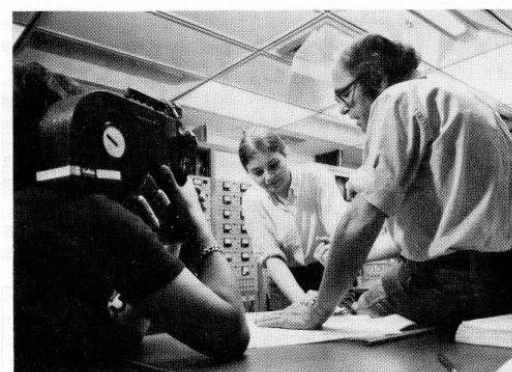

There is a 4th quark: Charm

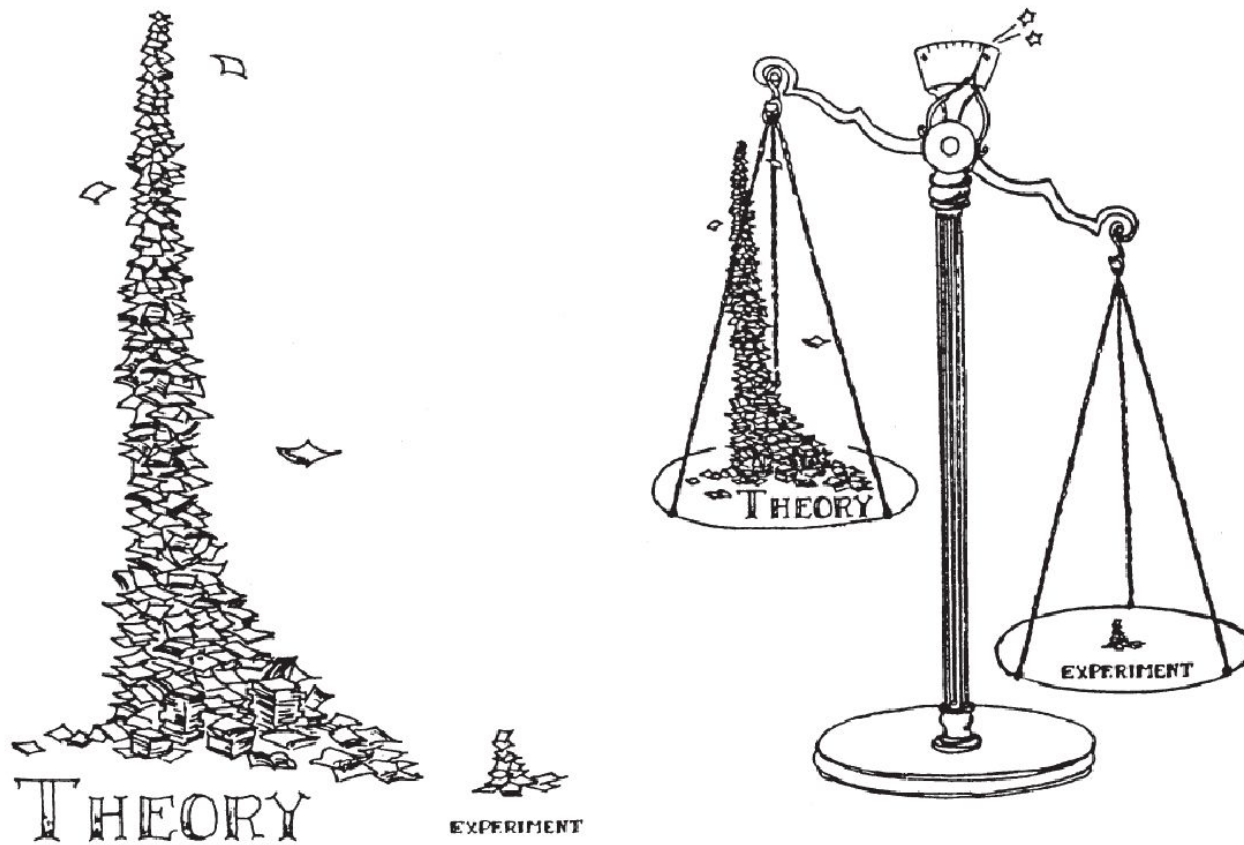

Richter & Ting Share 1976 Nobel Prize



"for their pioneering work in the discovery of a heavy elementary particle of a new kind"

2 years after the November Revolution

R

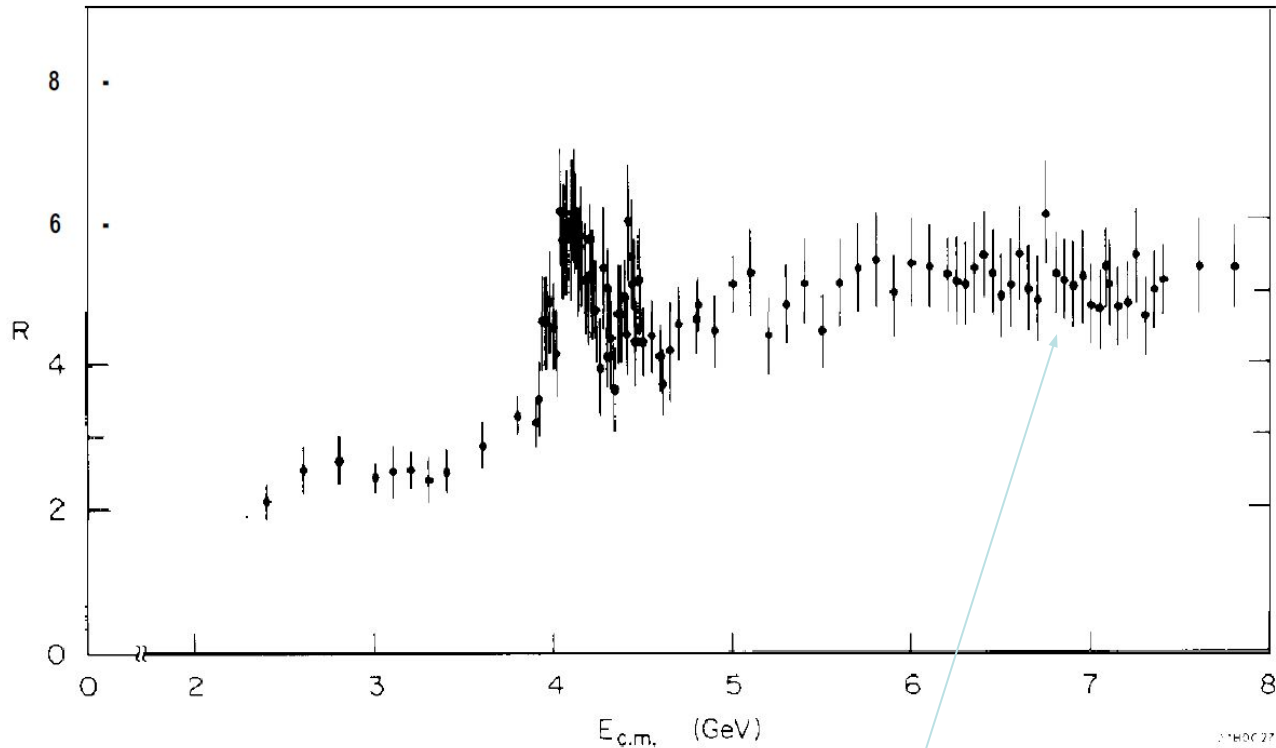

$R = \sigma_h / \sigma_{\mu\mu} = \sum_i q_i^2 \Psi, \psi'$ and their radiative tails removed.

4 colored quarks + τ + QCD corrections...

Haim Harari (Lepton Photon 75) first explained $R=5$ in a model with the “old” quark triplet and a new, heavy anti-quark triplet.

Discovery

Most “discovery” in physics is a painstaking process:

- Hints from theory
- Extensive data taking
- Careful analysis to extract a signal
- Is it $> 5 \sigma$?
- Careful review
- Well planned announcement

.....

The LHC Higgs discovery at the LHC is a rather good example of this.

The Ψ and the Ψ' were different, and different from each other.

- The Ψ was totally unexpected. Perhaps a broad bump, but nothing vaguely like this.
- Statistical significance was never a thought. We could (quite literally) hear the peak.
- The “announcement” was by chaotic telephone calls, resulting in PRL waiving their news embargo.
- The interval from discovery to publication submittal was 3 days!

“Nothing so strange and unexpected had happened in particle physics for many years,” - Richter - Nobel Prize lecture.

- The Ψ' mass was “suspected” via a crude positronium model by Terry Goldman and me.
- There was a systematic search that took a few hours to find it.
- Again, there was no question of statistics.

Monday	Tuesday	Wednesday	Thursday	Friday	Saturday	Sunday
28	29	30	31	1	2	3
4	5 Melbourne Cup	6	7	8 Agreement to run at low energy	9 Sharp resonance found	10 Rescan, start paper, answer phone calls!
11 Veterans Day Learn about J, finish paper, colloquia by Roy Schwitters and Sam Ting	12 Dhanteras	13 Ψ paper received at PRL.	14	15 Rather frantic press release, Frascati confirms Ψ/J	16	17 NYT Front page
18	19	20	21 Discover Ψ' at 3:20 am, colloquium by mb	22	23	24
25 Ψ' paper received at PRL	26	27	28 Thanksgiving Day	29	30	1

November 1974 has 19 work days.

🕒 3rd Quarter - 06 🌑 New Moon - 13 🕒 1st Quarter - 21 🌕 Full Moon - 29

🟢 Holiday 🟡 Celebrations

In Memoriam

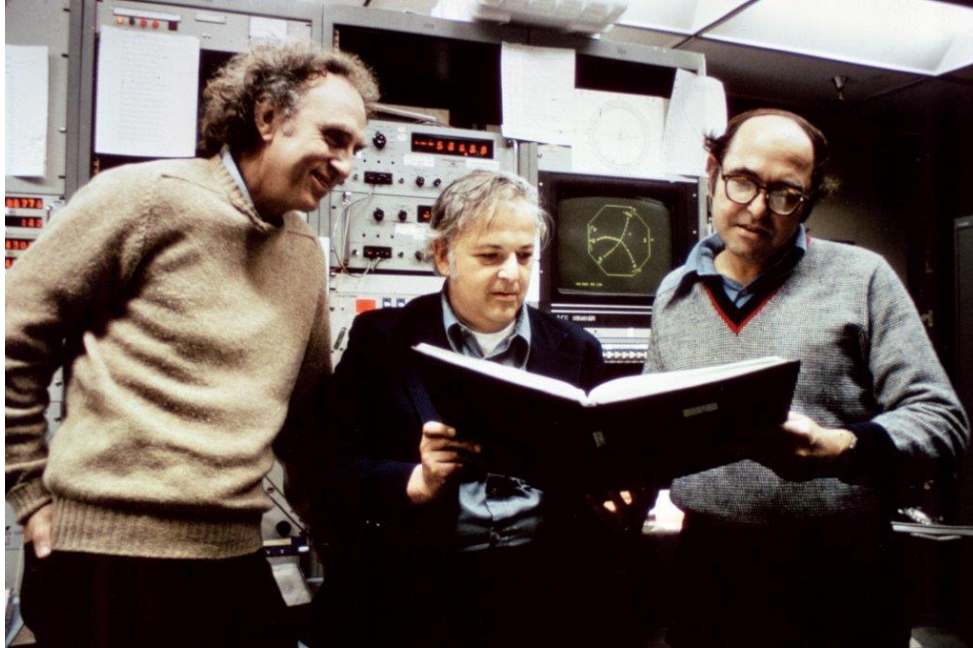

Martin Perl, Burt, Gerson Goldhaber



Rudy Larsen, Ewan Paterson, Burt



Norm Dean - SPEAR Vacuum Engineer

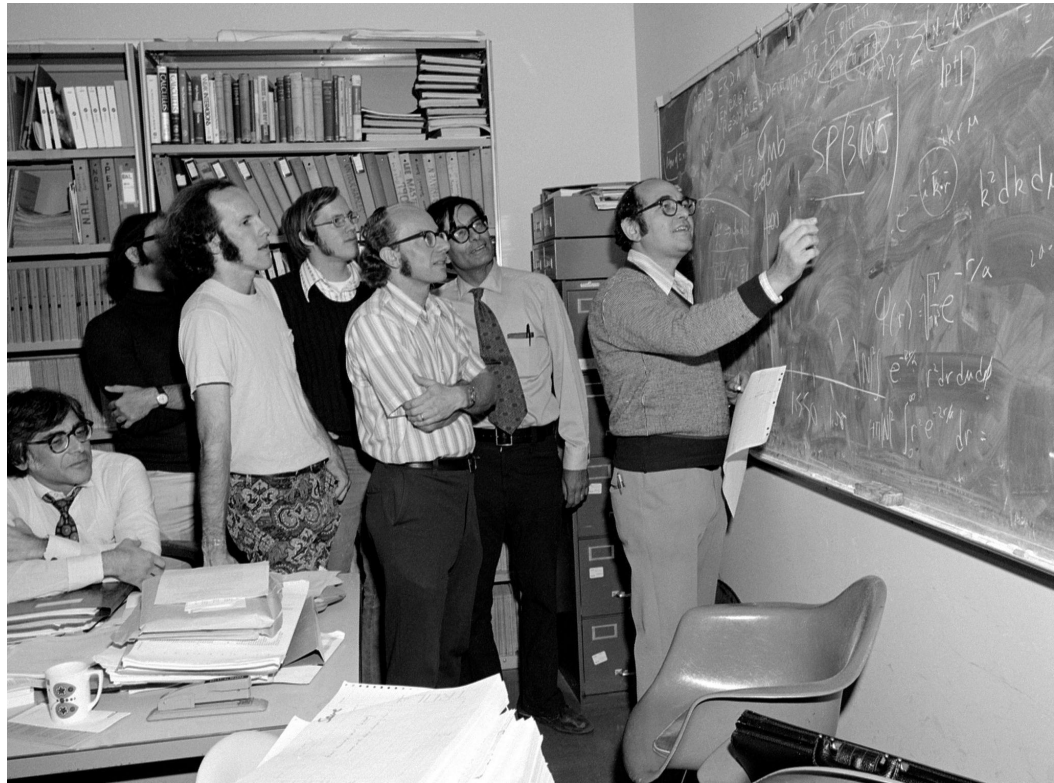

Gerson Goldhaber
George Trilling
John Kadyk



Burton, Ewan



Roy Schwitters

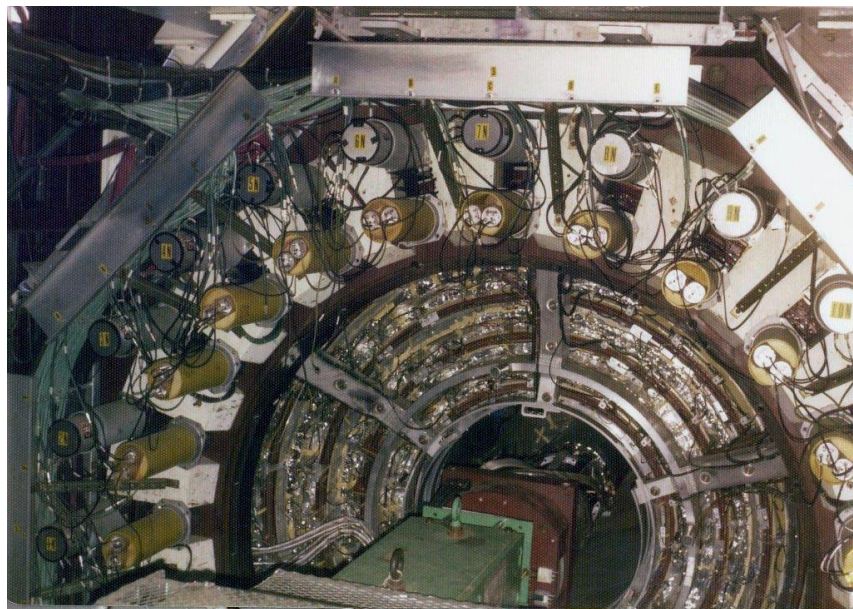

Richter likened SPEAR (and MK-I) to a character in *Alice in Wonderland*. “It’s like the Cheshire cat, there’s nothing left but its grin.”

Summary

- In the late 60's to early 70's, the SLAC-MIT deep inelastic experiments provided the experimental evidence first for partons and then their identification as quarks.
- The discovery of charm in 1974 convinced any last doubters and established the Standard Model.
- In the early days of quarks and the standard model, SLAC was a good place to be!

Acknowledgments

B. Richter Nobel Lecture

H.L. Lynch Photographs

V. Lüth Photographs

SLAC Archives

M. Riordan *The Hunting of the Quark*

And many, many conversations and experiences with colleagues and friends

The machine and detector collaborations

SLAC - LBL Magnetic Detector Collaboration

SPEAR Storage Ring Group -1972

SLAC

- J.E. Augustin
- A.M. Boyarski
- M. Breidenbach
- **F. Bulos**
- J.T. Dakin
- G.J. Feldman
- **G.E. Fischer**
- D. Fryberger
- G. Hanson
- B. Jean-Marie
- **R.R. Larsen**
- V. Luth
- H.L. Lynch
- D. Lyon
- C.C. Morehouse
- **J.M. Paterson**
- **M.L. Perl**
- **B. Richter**
- P. Rapidis
- **R.F. Schwitters**
- W.M. Tanenbaum
- F. Vanucci

LBL and UC Berkeley

- **G.S. Abrams**
- D. Briggs
- W. Chinowsky
- C.E. Friedberg
- **G. Goldhaber**
- R.J. Hollebeek
- **J.A. Kadyk**
- B. Lulu
- F. Pierre
- **G.H. Trilling**
- J.S. Whittaker
- **J. Wiss**
- **J.E. Zipse**

- M. Allen
- J. E. Augustin
- A.M. Boyarski
- **B. Richter**
- **N. Dean**
- **G.E. Fischer**
- **J. Haissinski**
- J. L. Harris
- L. Karvonen
- M. J. Lee
- **J. Rees**

- **R. R. Larsen**
- R. McConnell
- **P. Morton**
- A. Sabersky
- R. Scholl
- **J. Voss**
- **W. Davies-White**
- **H. Wiedemann**

deceased