

Quarkonium Production at JLab and EIC

Sylvester Joosten

sylvester.joosten@temple.edu

Next-Generation GPD studies with exclusive meson production at EIC,
Stony Brook University, June 2018

Quarkonium in electro- and photo-production

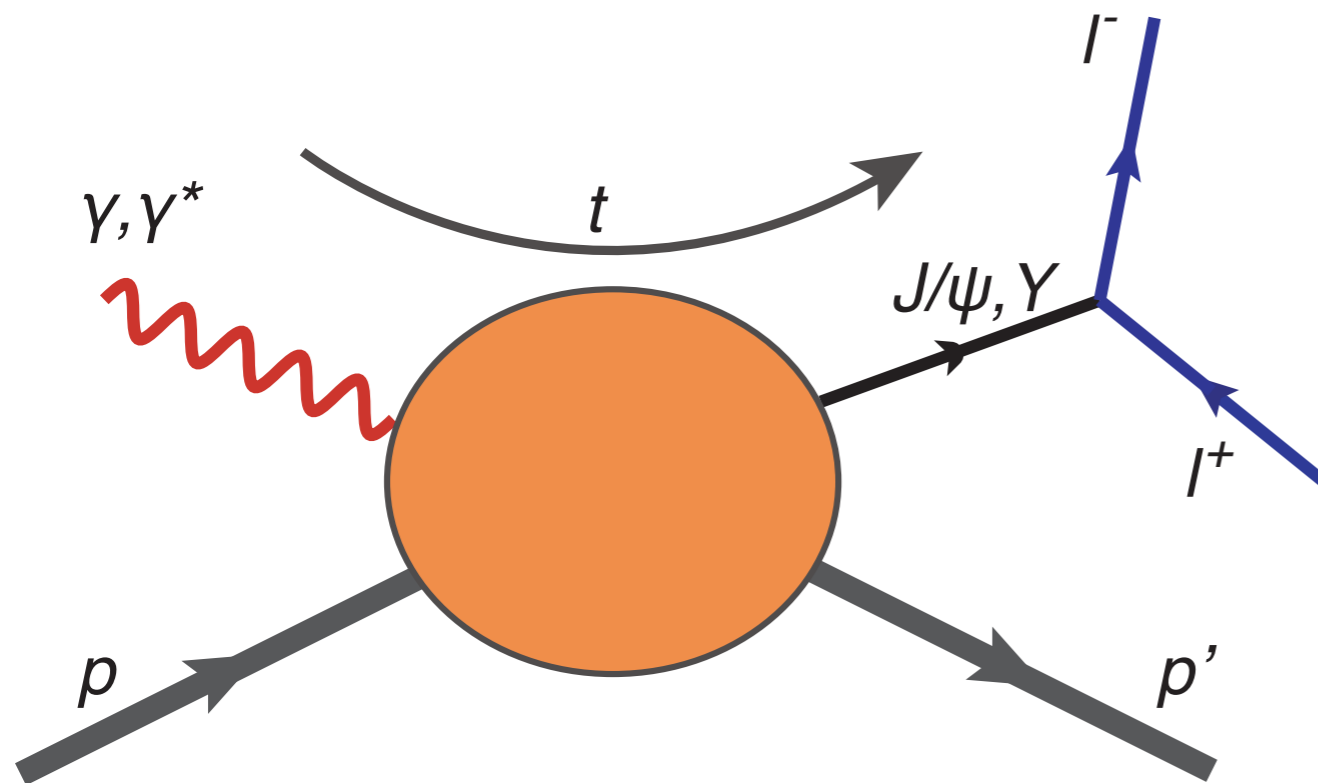

- Strong gluonic interaction between color neutral objects
- Minimal quark exchange
- **Quarkonium as a probe to study the gluonic structure of the nucleon**

Quarkonium photo-production: what do we know?

J/ψ photo-production:

☆ Direct photo-production

Cornell '75,
SLAC '75,
CERN NA-14,
FNAL E401, E687

☆ Electro-production (quasi-real)

H1 and ZEUS

☆ Ultra-peripheral pp collisions

LHCb '14

$Y(1s)$ photo-production:

☆ Electro-production (quasi-real)

H1 and ZEUS

☆ Ultra-peripheral pp collisions

LHCb '15

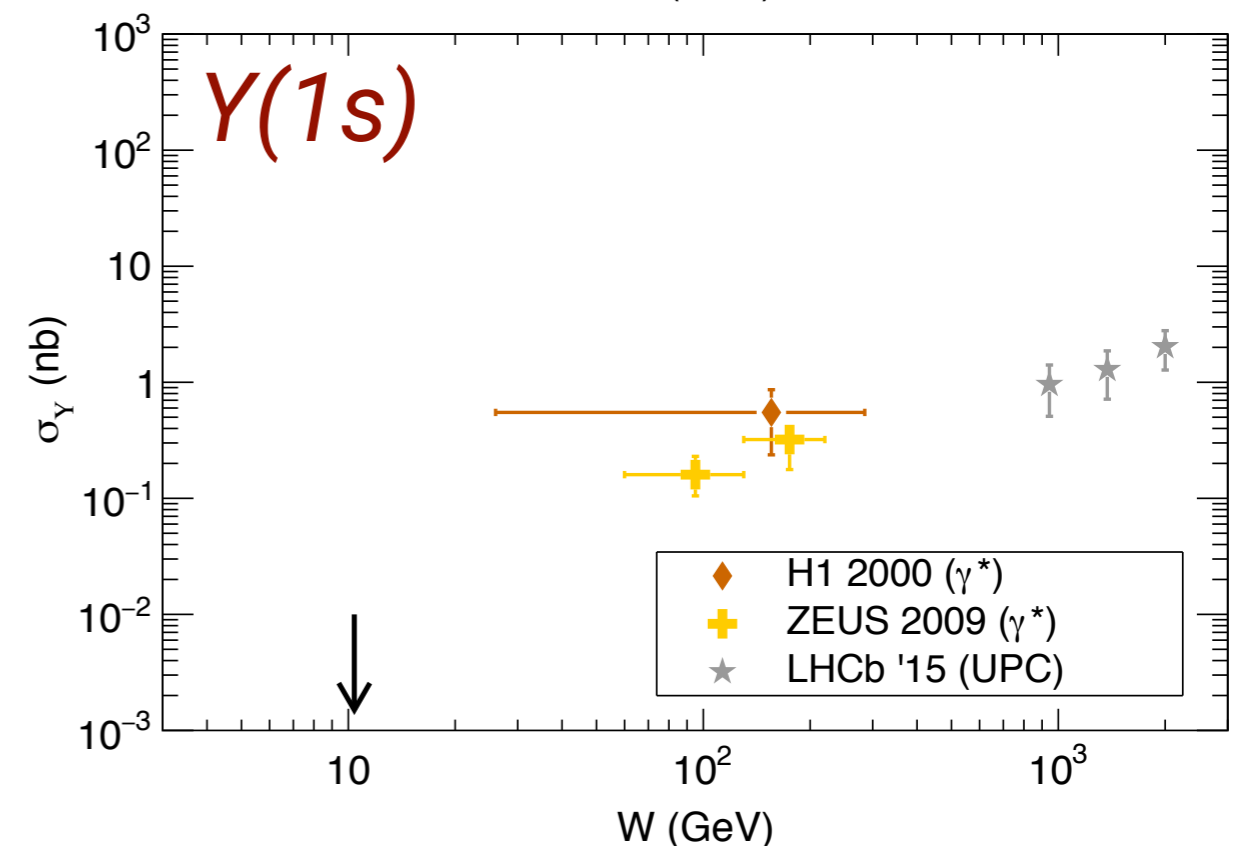
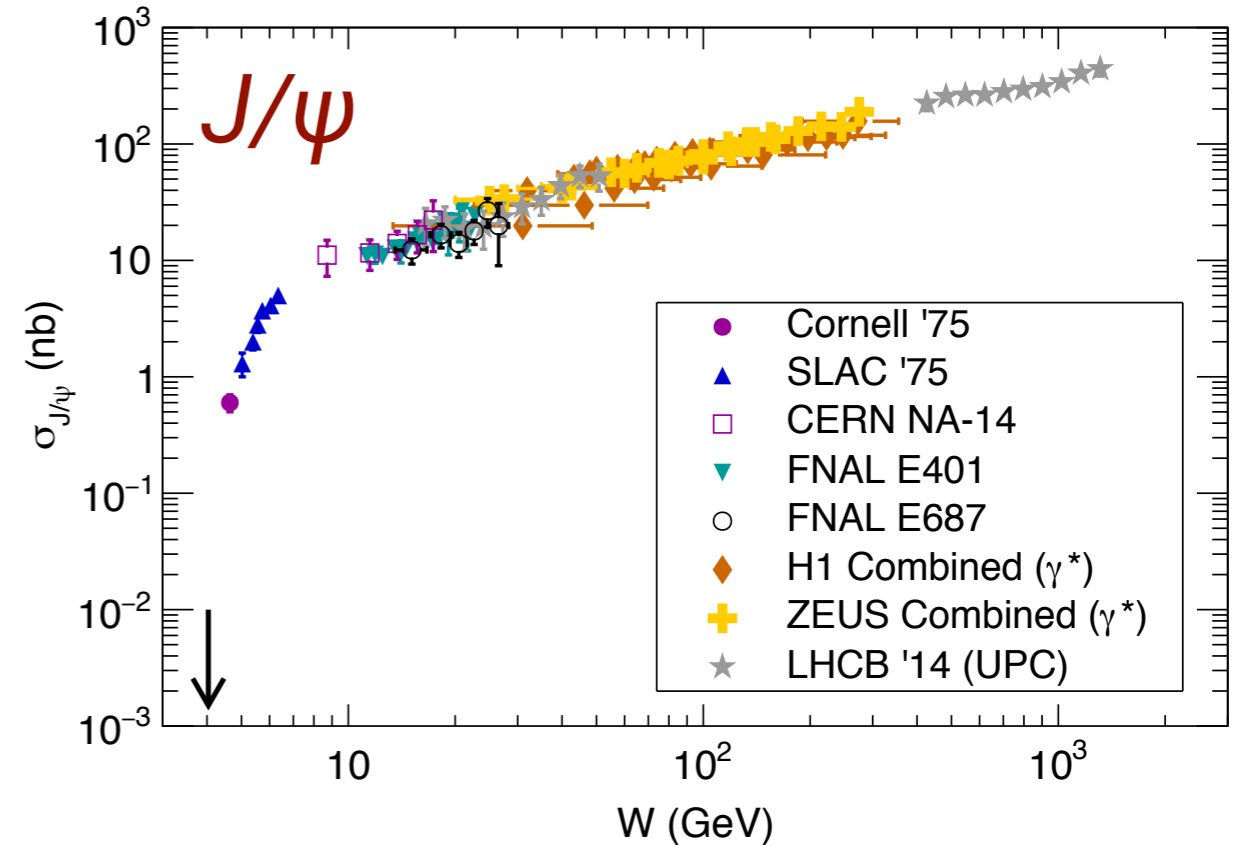

Quarkonium photo-production: what do we know?

J/ψ photo-production:

- ☆ Well constrained above $W > 15$ GeV
 - Dominated by t -channel 2-gluon exchange
- ☆ Almost no data near threshold

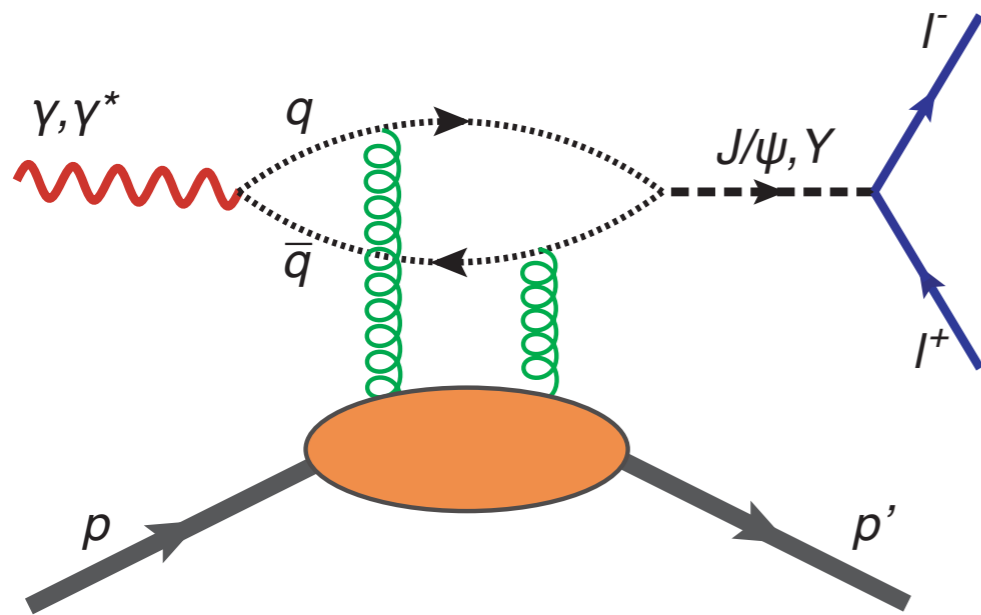

$Y(1s)$ photo-production:

- ☆ Not much available
 - ZEUS measured 62 ± 12 events total!

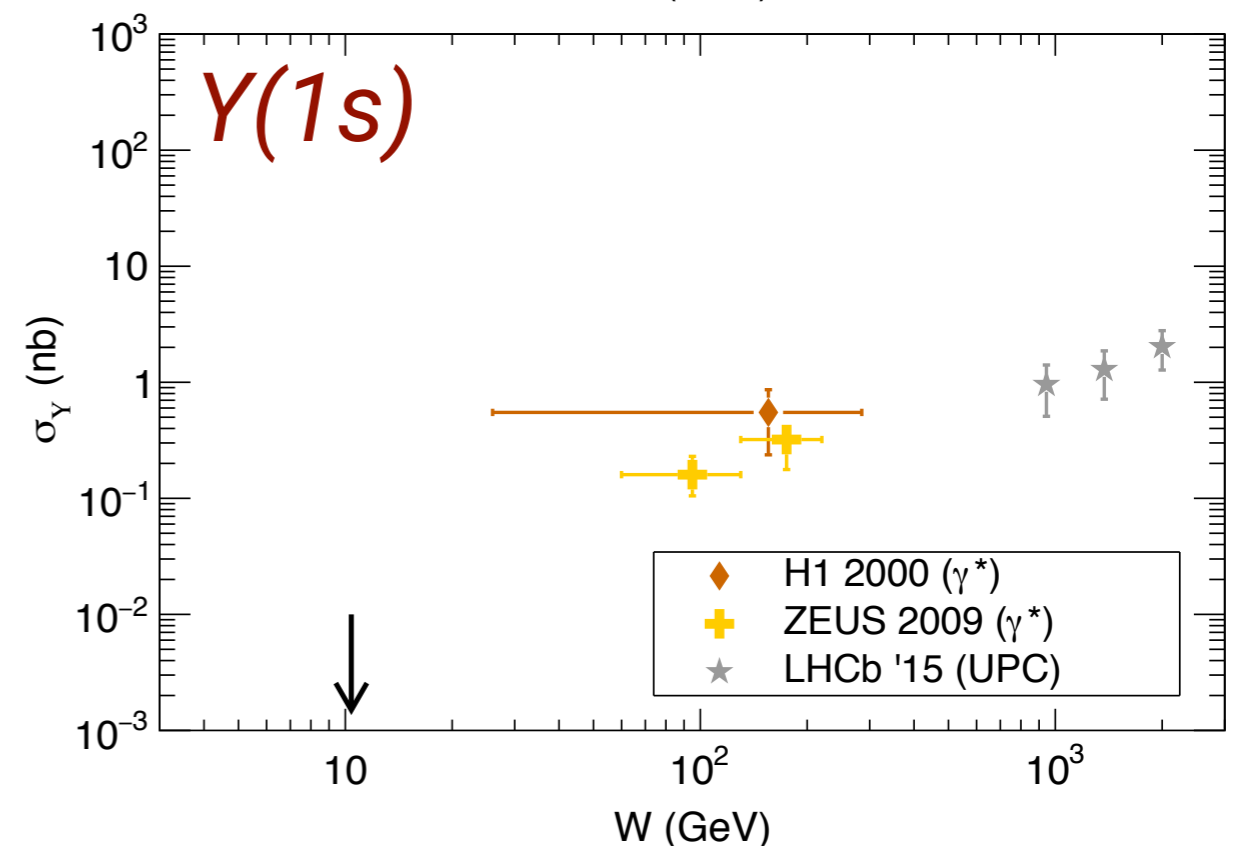
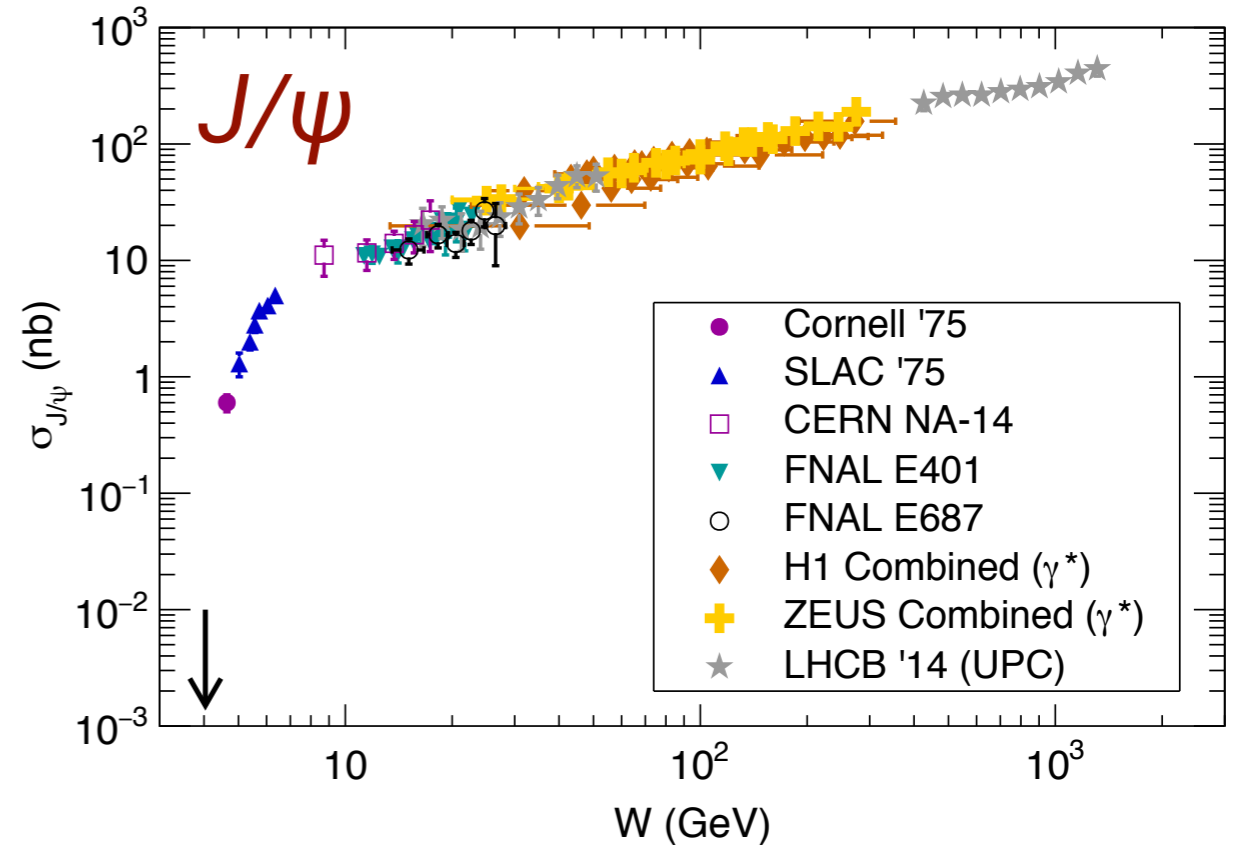

Why the **threshold region**?

Near Threshold:

- ☆ **Origin of proton mass**, trace anomaly of the QCD energy-momentum tensor.
- ☆ **Gluonic Van der Waals force**, possible quarkonium-nucleon/nucleus **bound states**
- ☆ **Mechanism** for quarkonium production

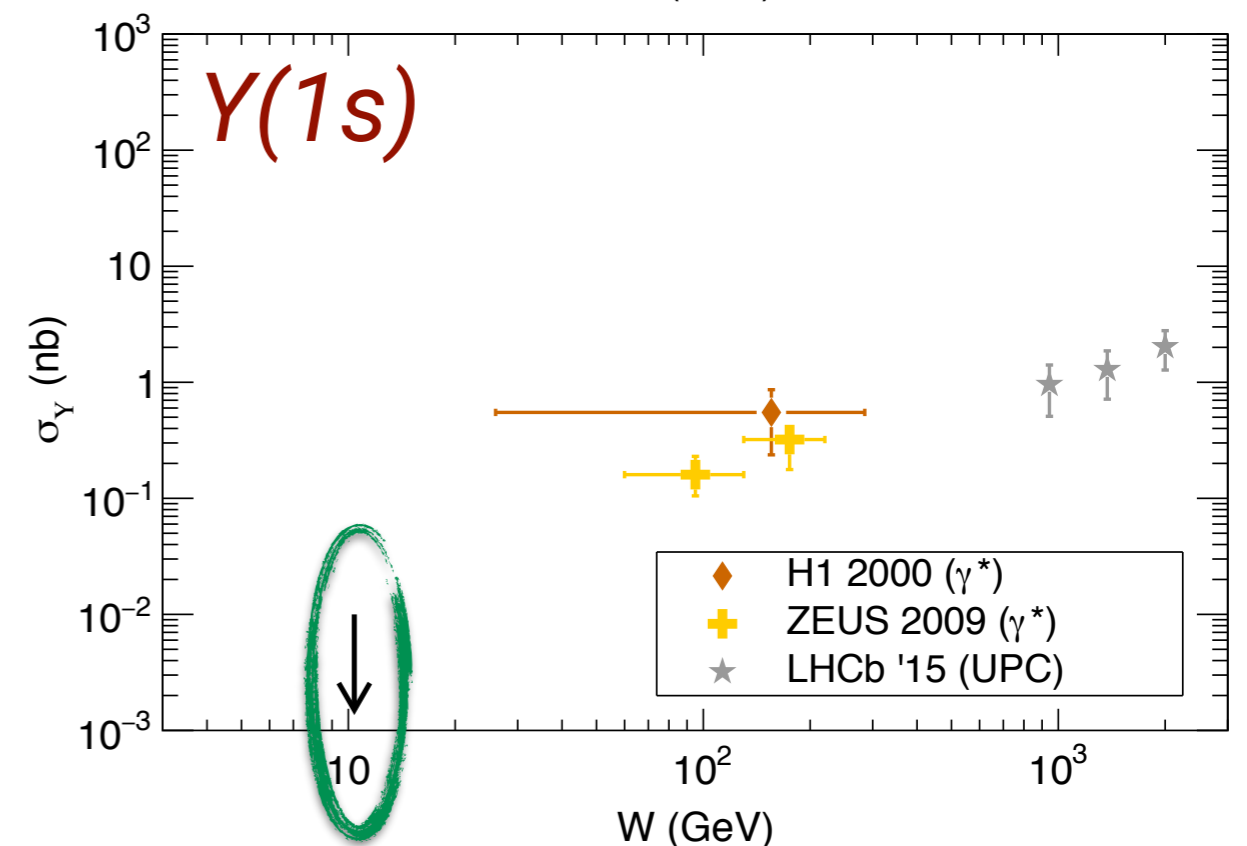
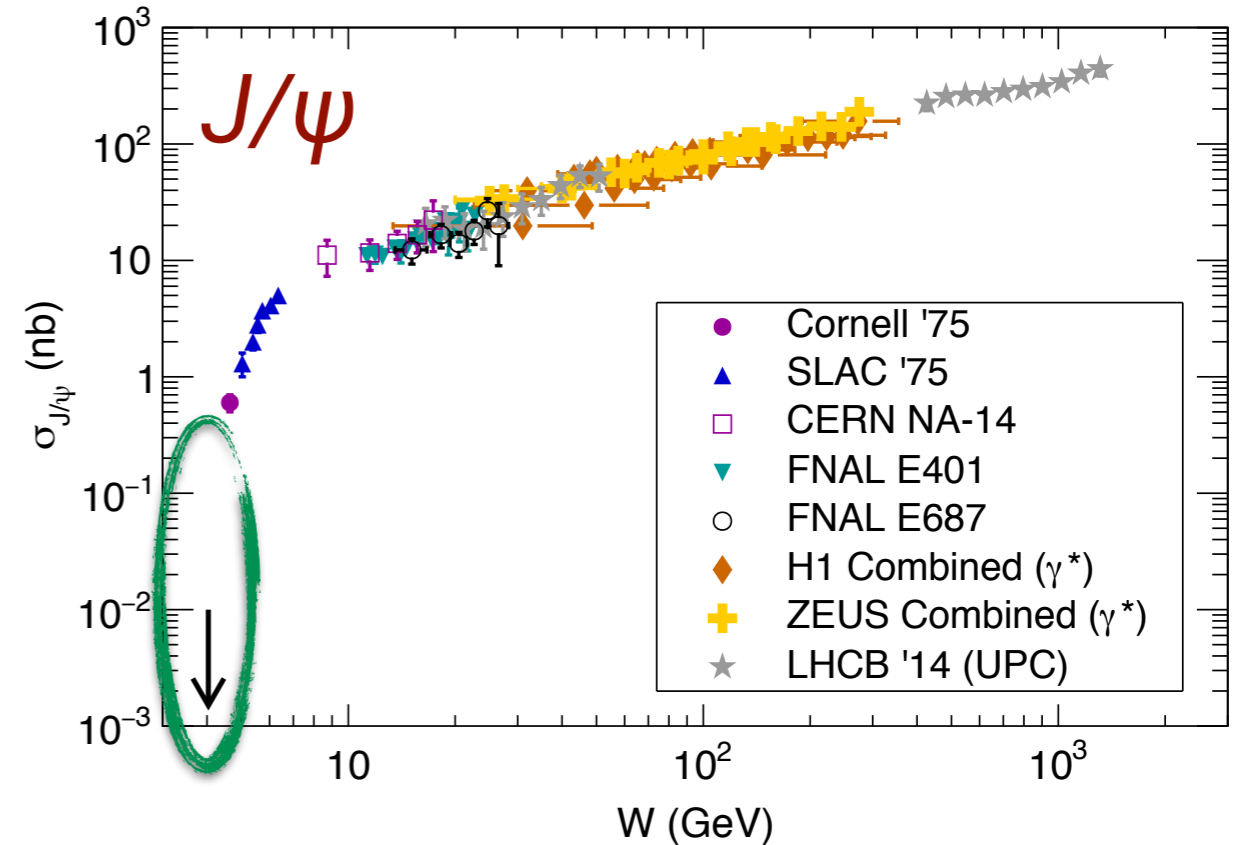

Why the **threshold region**?

Near Threshold:

- ☆ **Origin of proton mass**, trace anomaly of the QCD energy-momentum tensor.
- ☆ **Gluonic Van der Waals force**, possible quarkonium-nucleon/nucleus **bound states**
- ☆ **Mechanism** for quarkonium production

☆ **J/ψ program at Jefferson Lab**

☆ **$Y(1s)$ production at an EIC**

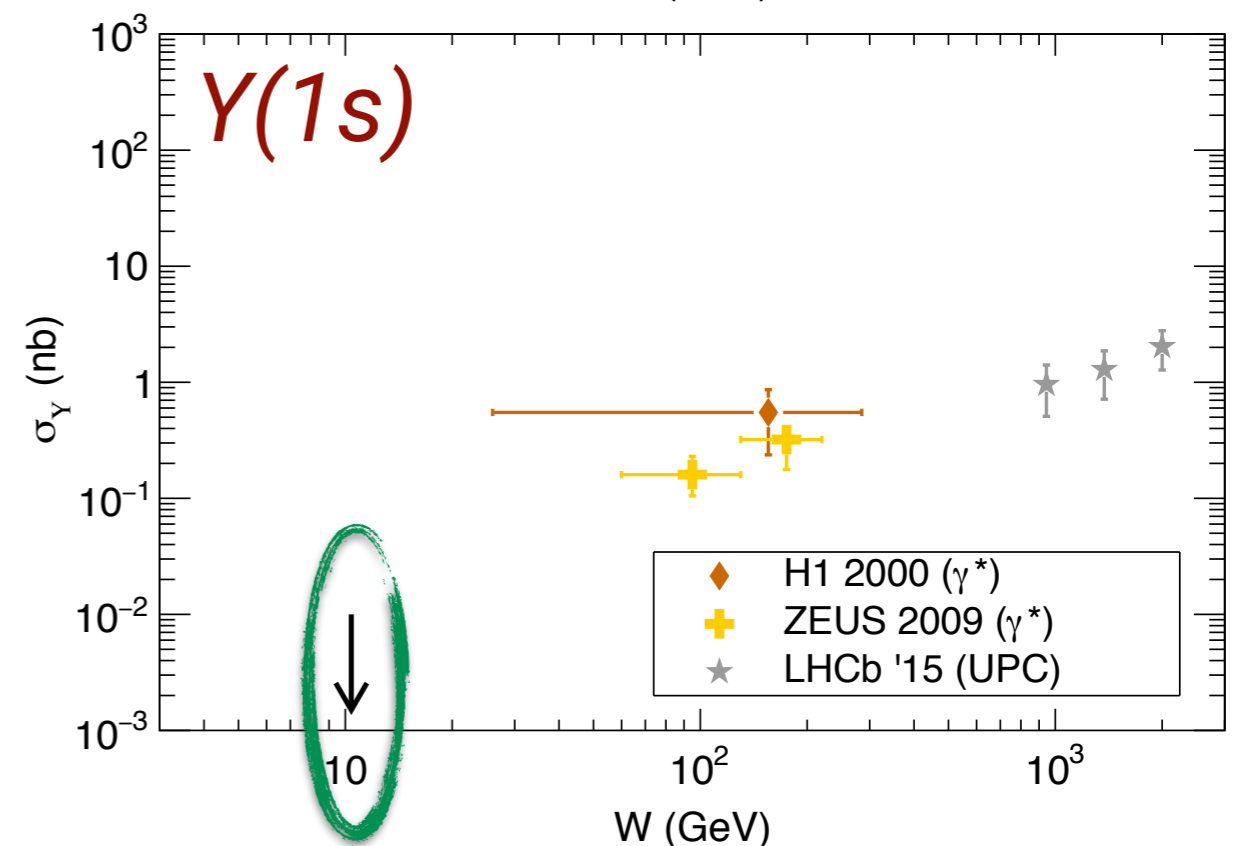
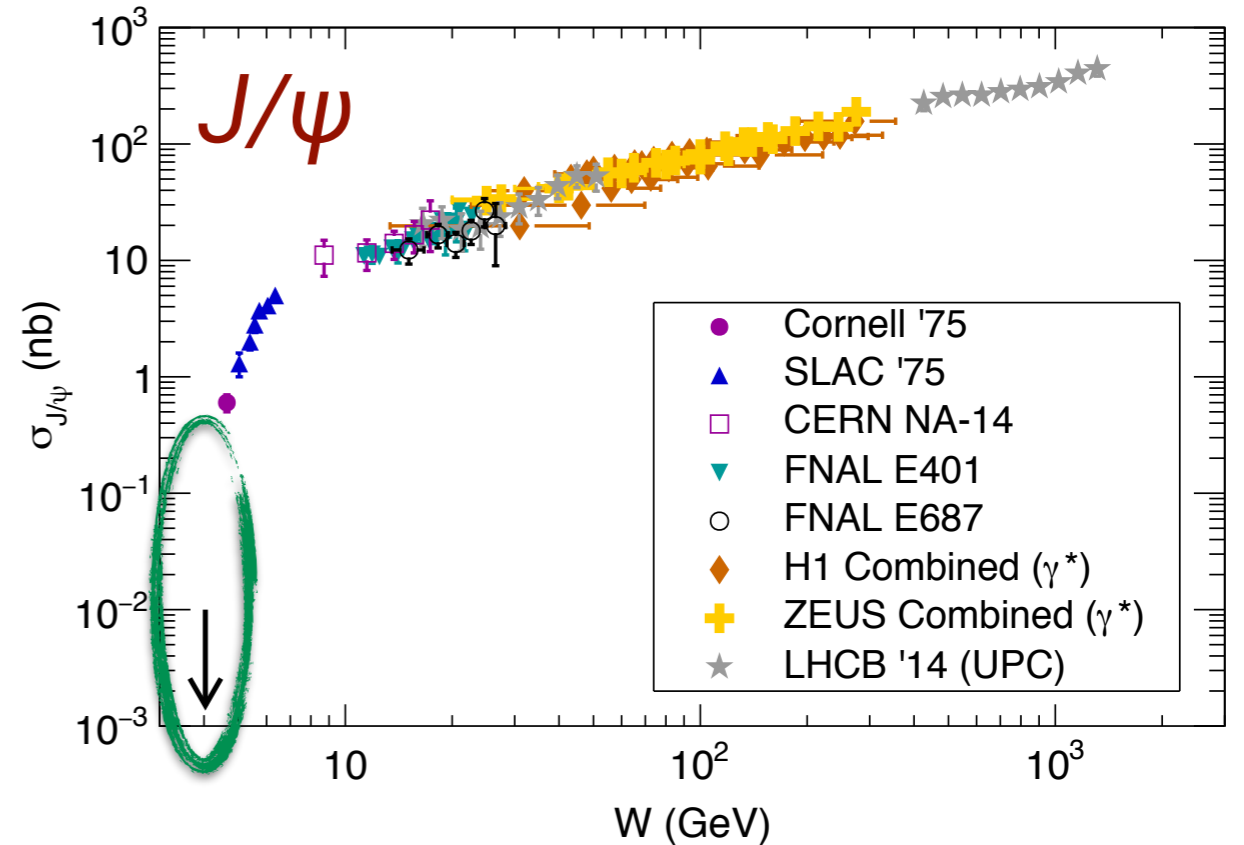

Why electro-production at high energies?

High Energies

- ☆ Access **Gluon GPD**: Full 3D tomography of the gluonic structure of the nucleon
- ☆ L-T separation and the Q^2 dependence of R for quarkonium production

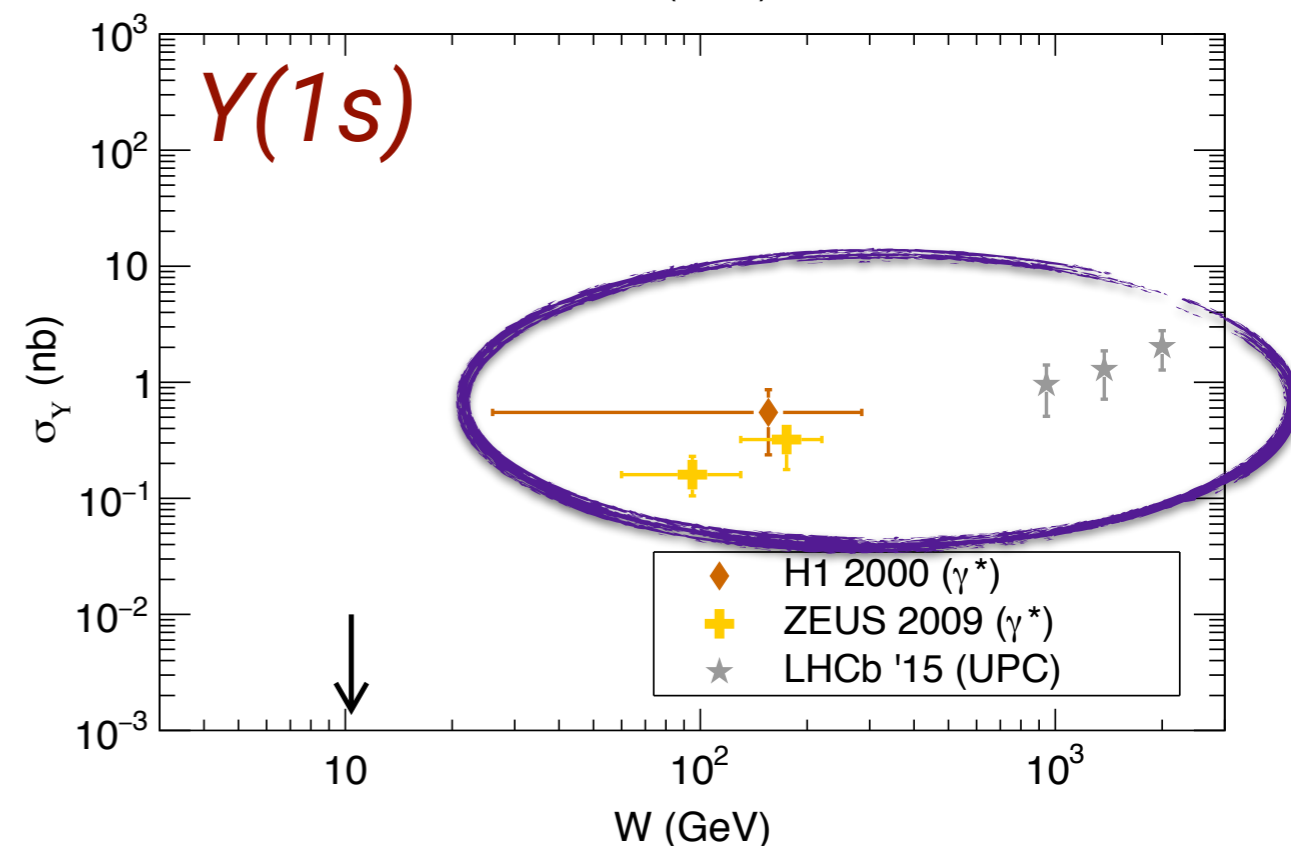
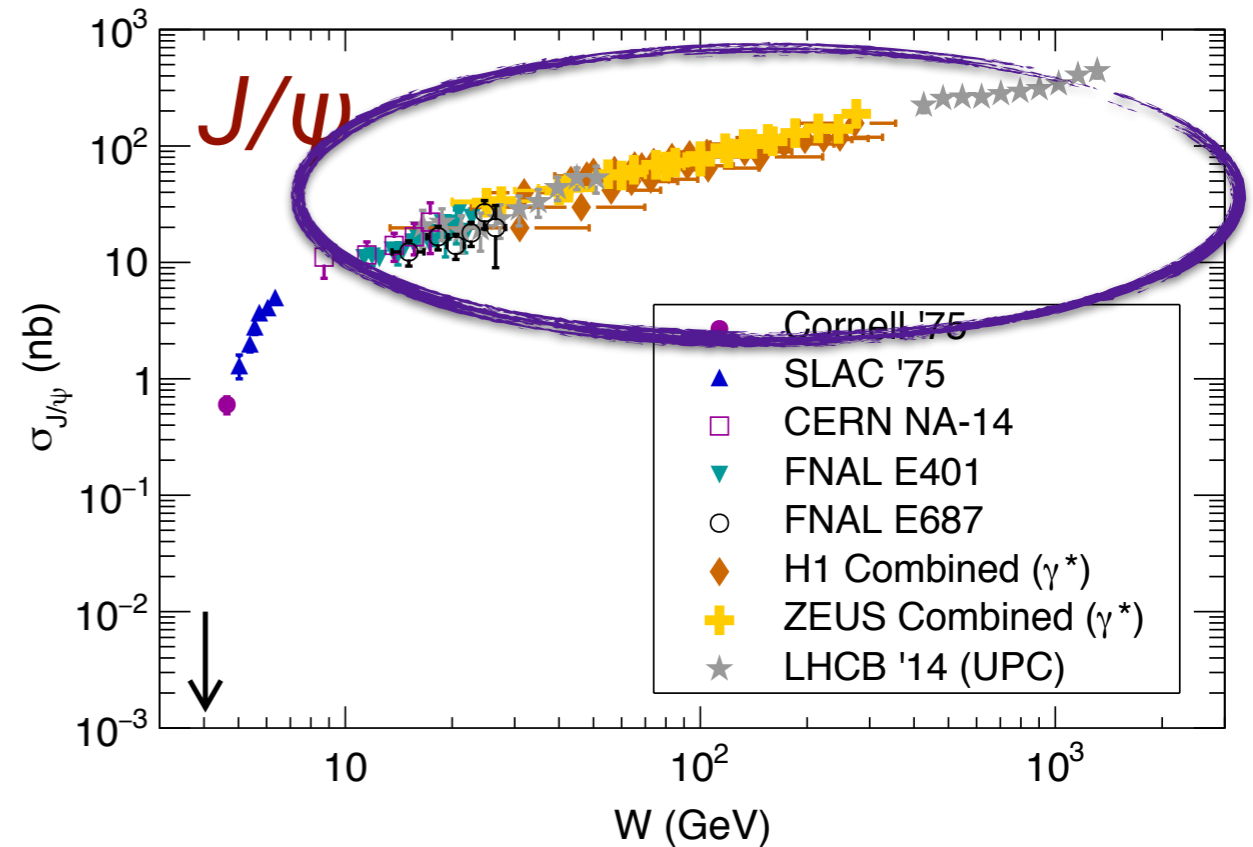

Why electro-production at high energies?

High Energies

- ☆ Access **Gluon GPD**: Full 3D tomography of the gluonic structure of the nucleon
- ☆ L-T separation and the Q^2 dependence of R for quarkonium production

- ☆ J/ψ production at an EIC
- ☆ $Y(1s)$ production at an EIC

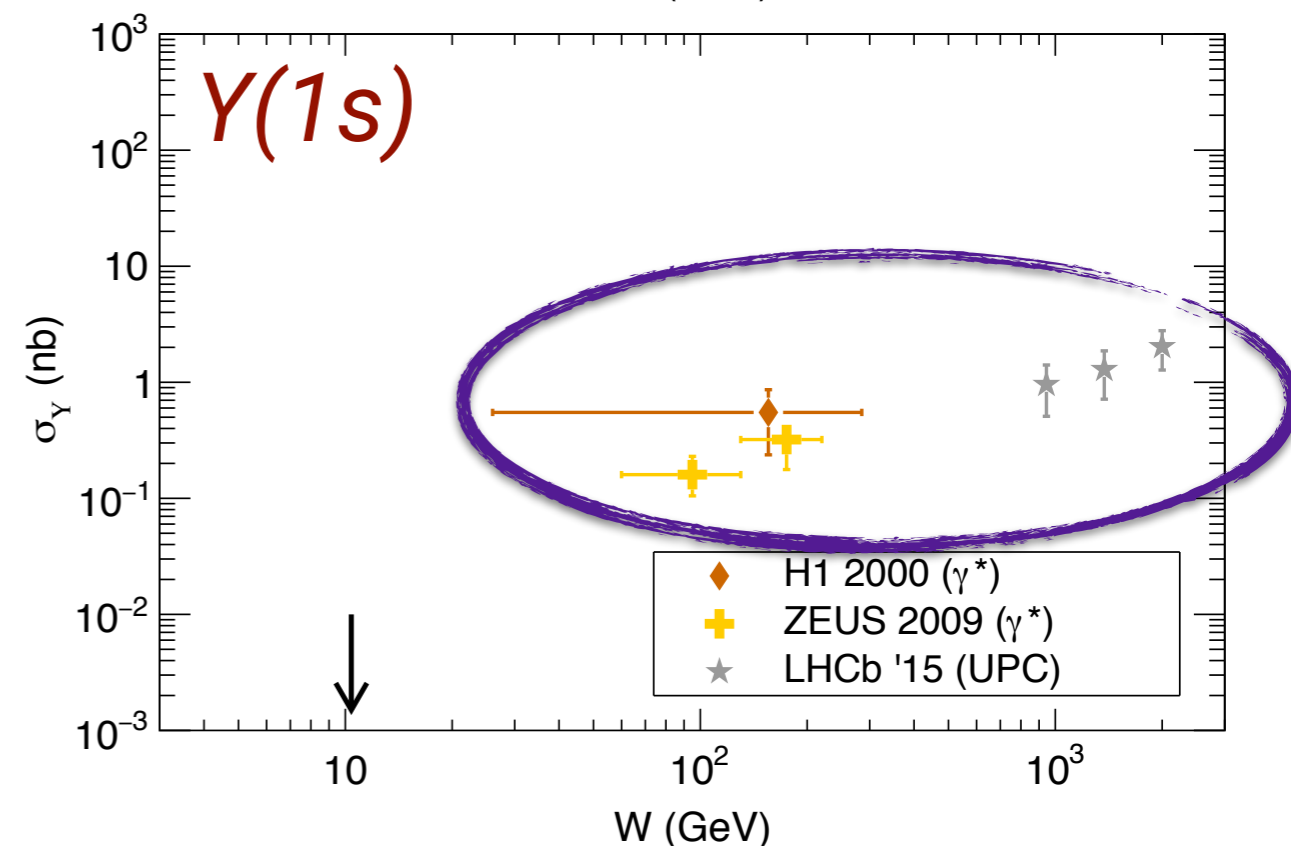
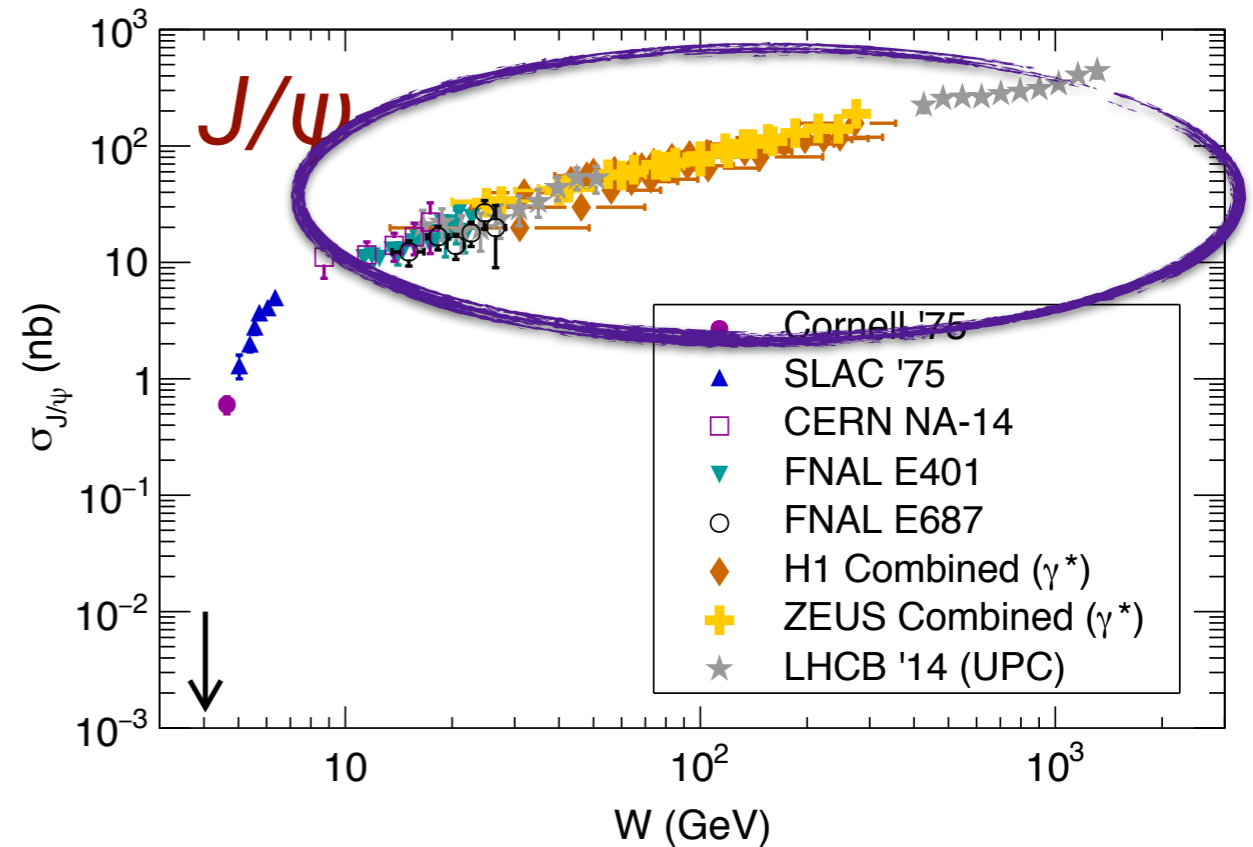

Quarkonium production **near threshold**

Production mechanism near threshold unknown

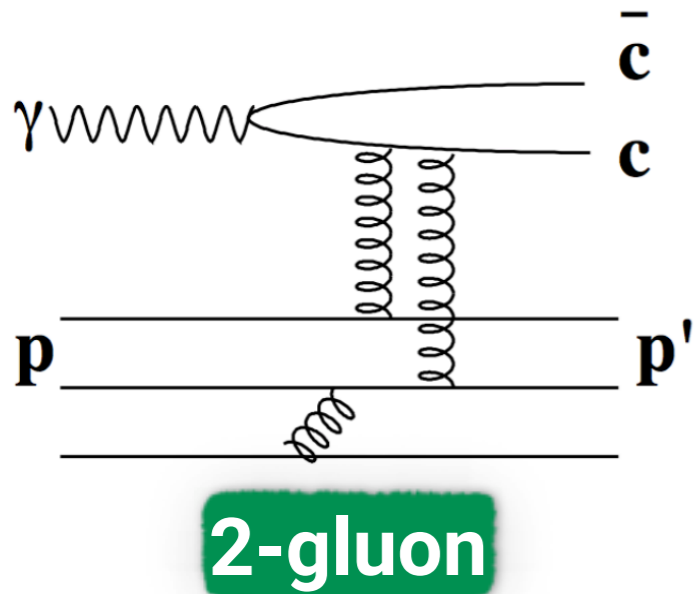

S.J. Brodsky, et al., Phys.Lett. B498, 23-28 (2001)

- ★ Same as high energies (**2-gluon**)?

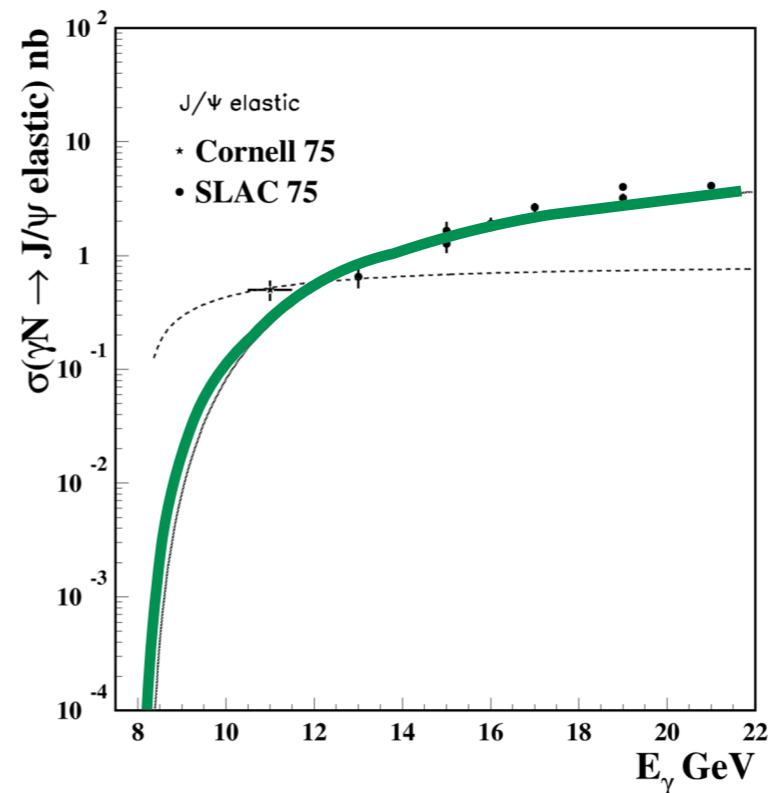

Production mechanism near threshold unknown

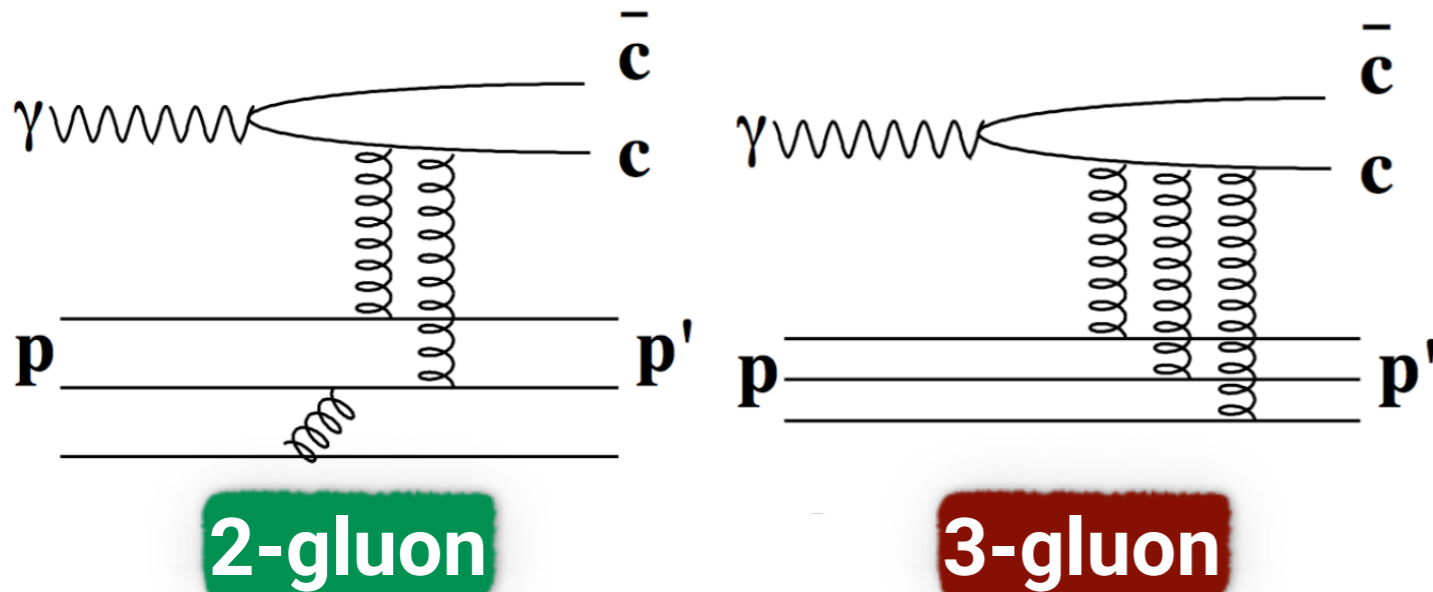

S.J. Brodsky, et al., Phys.Lett. B498, 23-28 (2001)

- ☆ Same as high energies (**2-gluon**)?
- ☆ Maybe **3-gluon** exchange dominant?

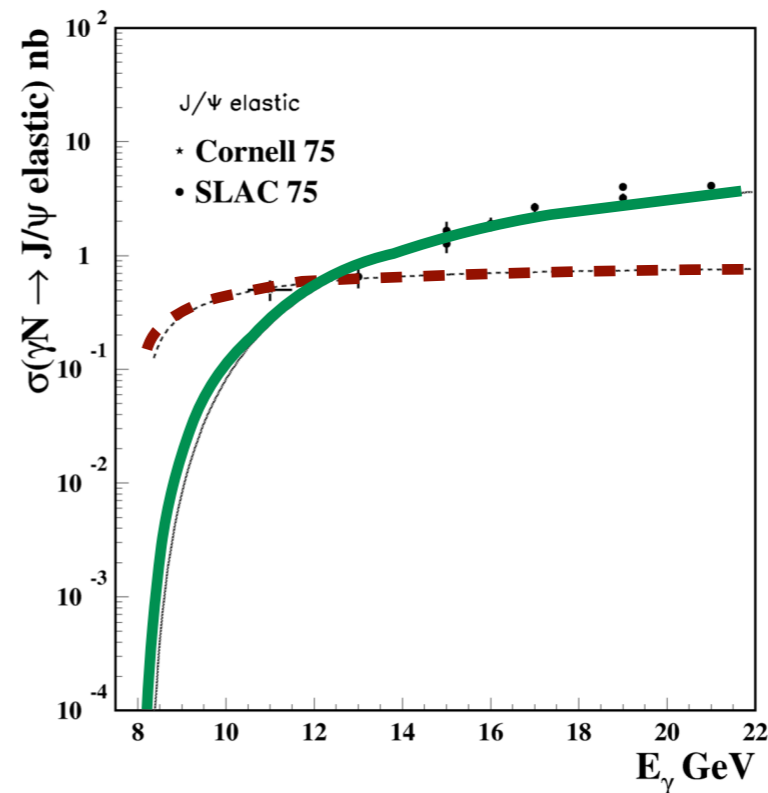

Production mechanism near threshold unknown

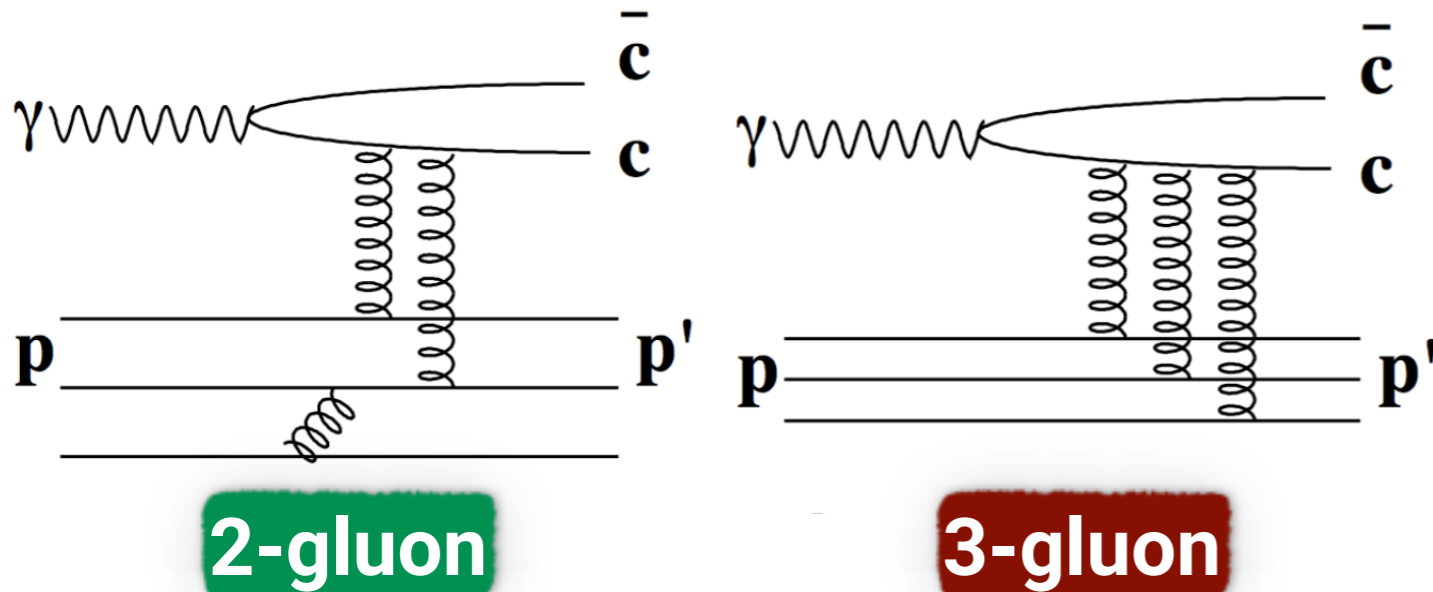

S.J. Brodsky, et al., Phys.Lett. B498, 23-28 (2001)

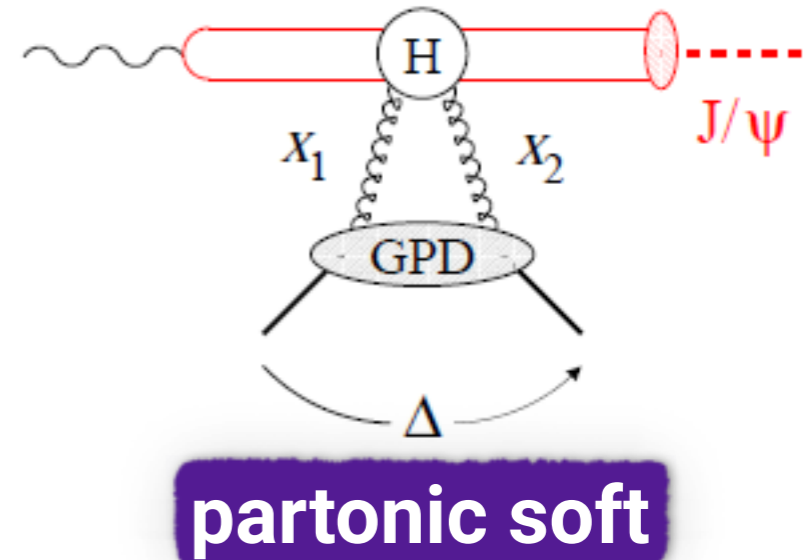

Frankfurt and Strikman., PRD66 (2002), 031502

- ☆ Same as high energies (**2-gluon**)?
- ☆ Maybe **3-gluon** exchange dominant?

- ☆ Or a **partonic soft mechanism** (power law 2-gluon form-factor)?

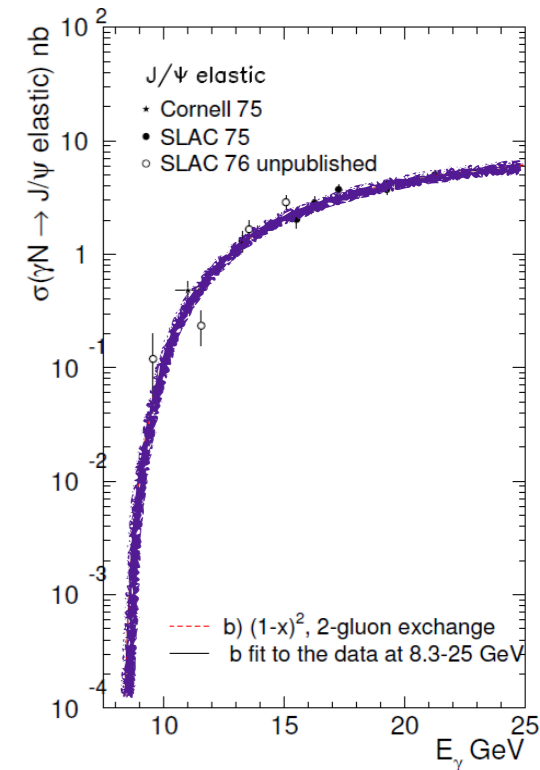
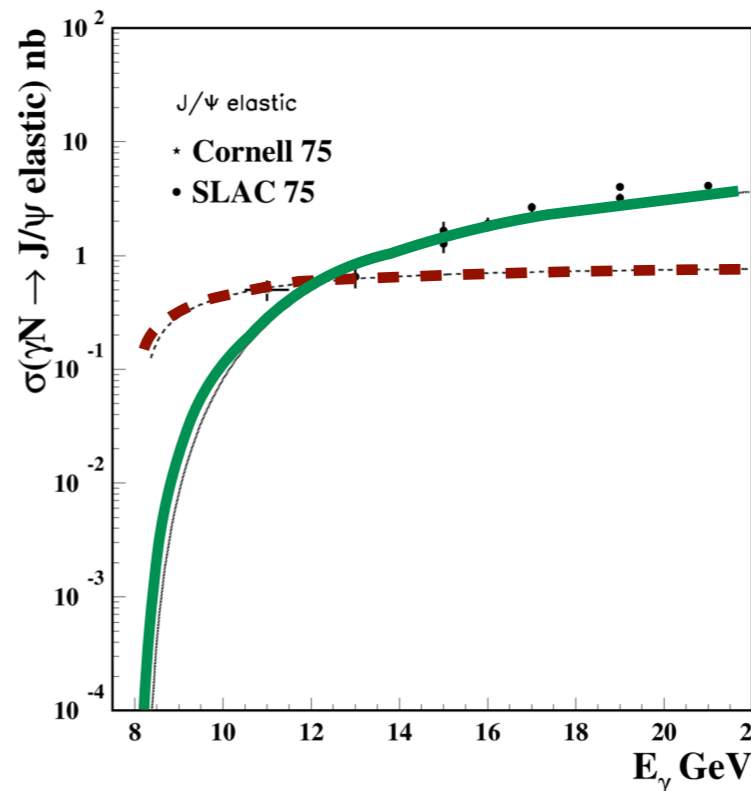

Production mechanism near threshold unknown

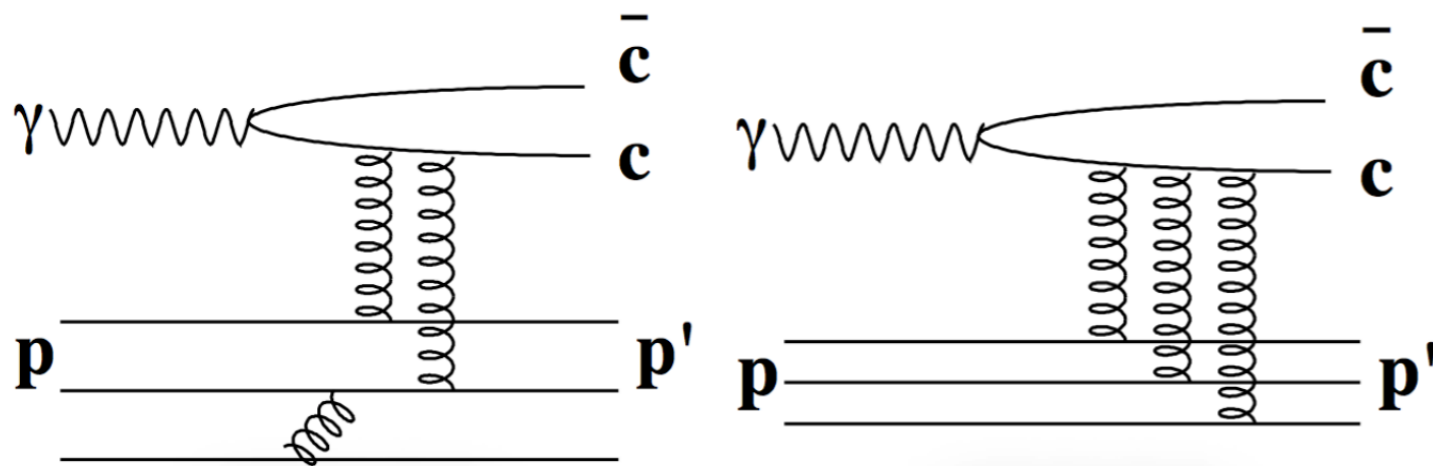

2-gluon

3-gluon

S.J. Brodsky, et al., Phys.Lett. B498, 23-28 (2001)

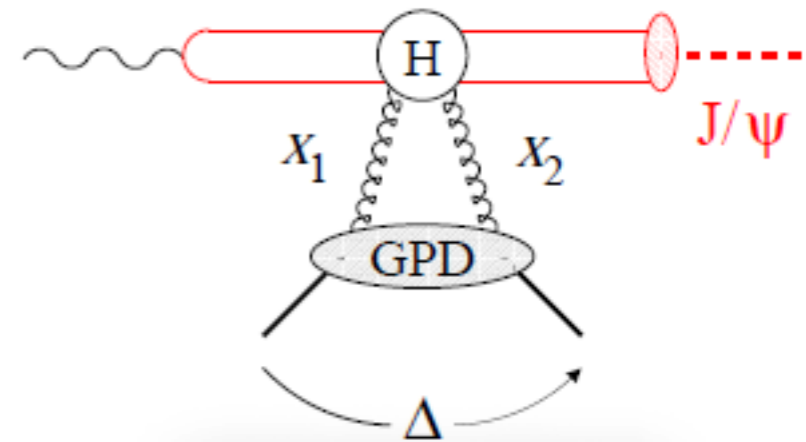

partonic soft

Frankfurt and Strikman., PRD66 (2002), 031502

- ★ Same as high energies (**2-gluon**)?
- ★ Maybe **3-gluon** exchange dominant?

- ★ Or a **partonic soft mechanism** (power law 2-gluon form-factor)?

- ★ Orders of magnitude difference
- ★ **2-gluon** fastest drop-off
- ★ **Drives required luminosity for threshold measurement**

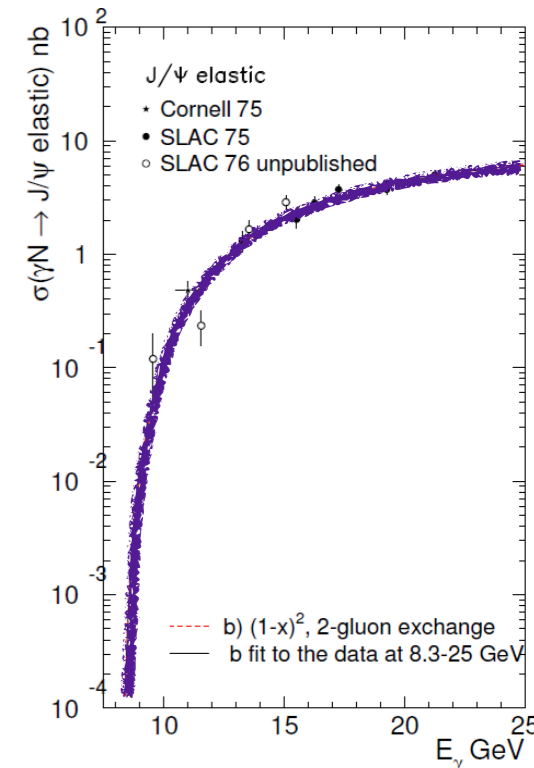
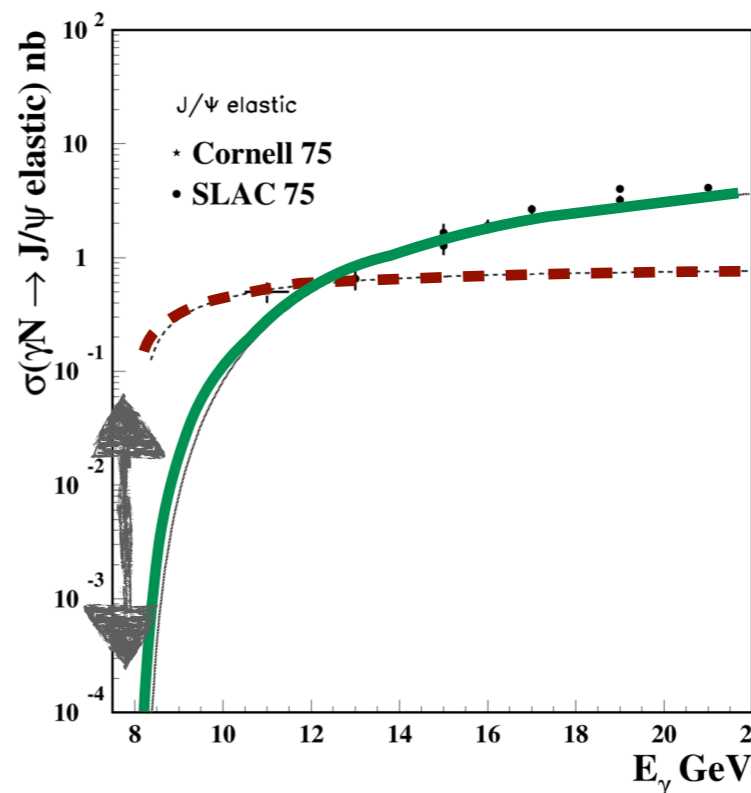

2-gluon fit near threshold

- ★ Smallest cross section drives required precision and luminosity
- ★ Use **2-gluon estimate for experimental projections** near threshold

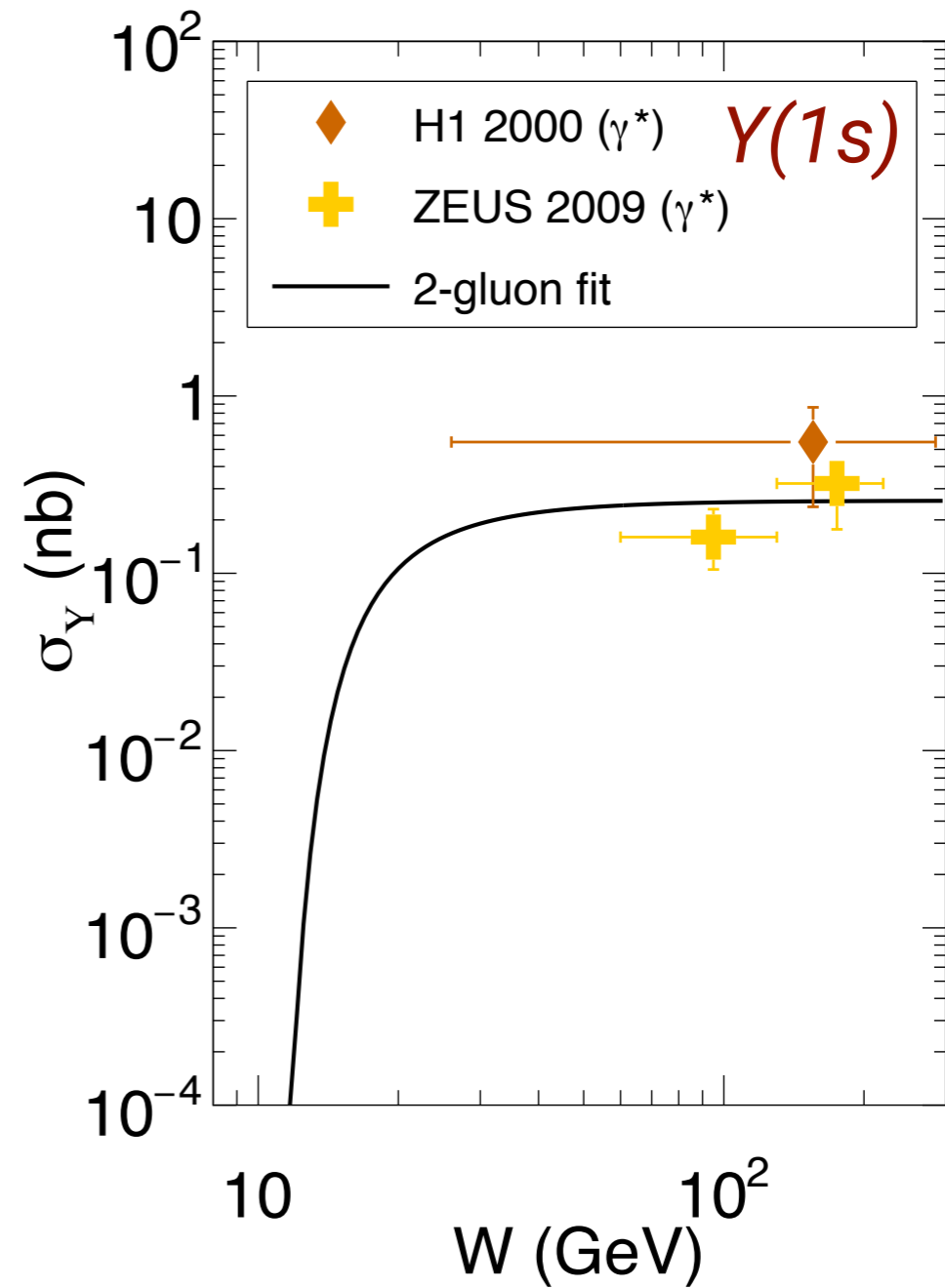
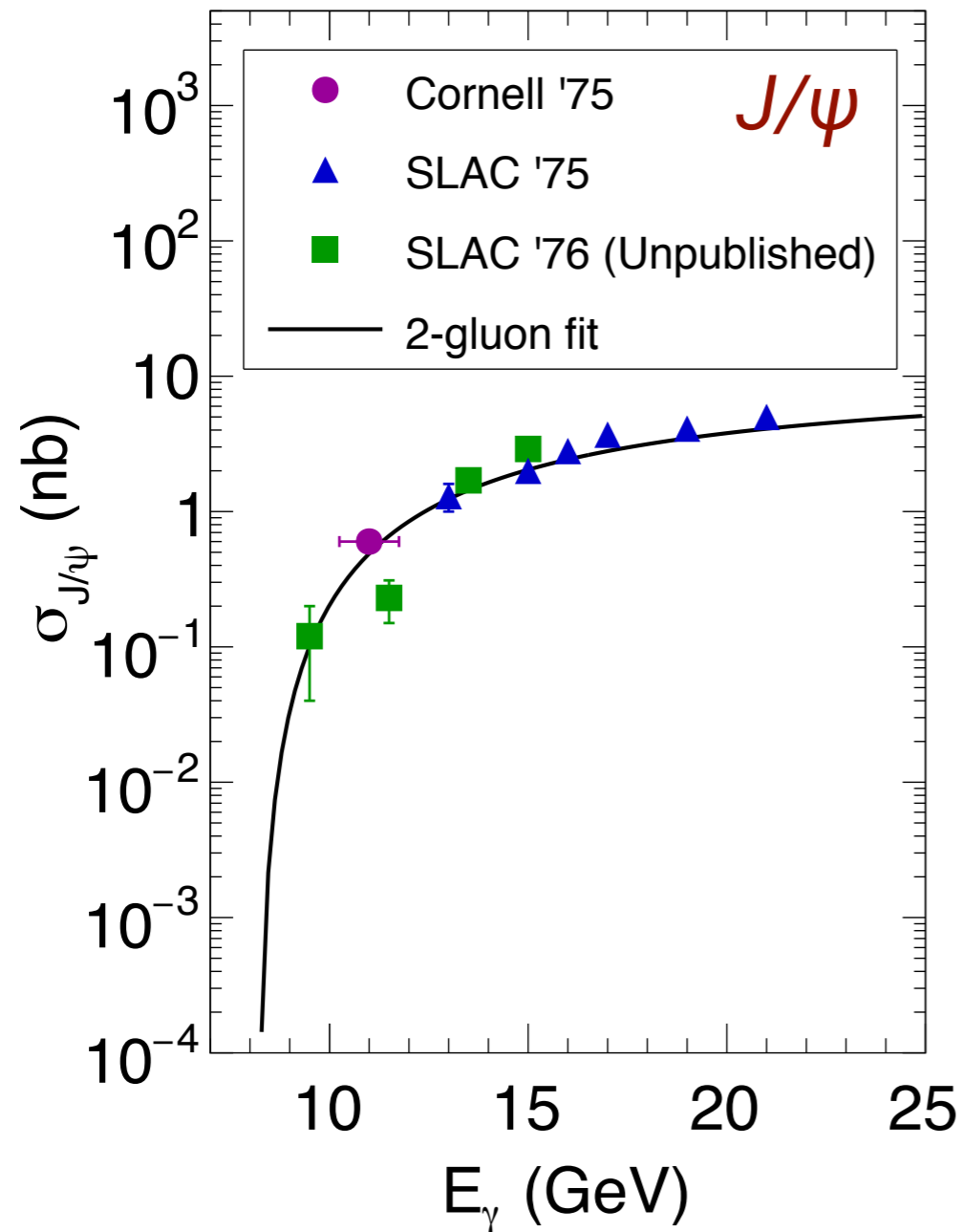

Quarkonium-nucleon scattering amplitude



Quarkonium-nucleon scattering amplitude



- ★ VMD relates photo-production cross section to quarkonium-nucleon scattering amplitude $T_{\psi p}$

Quarkonium-nucleon scattering amplitude



- ★ VMD relates photo-production cross section to quarkonium-nucleon scattering amplitude $T_{\psi p}$
- Approach works well at **high energies**, constrains $\text{Im}(T_{\psi p})$
- Need $\text{Re}(T_{\psi p})$ to describe threshold region (calculated through dispersion relations)

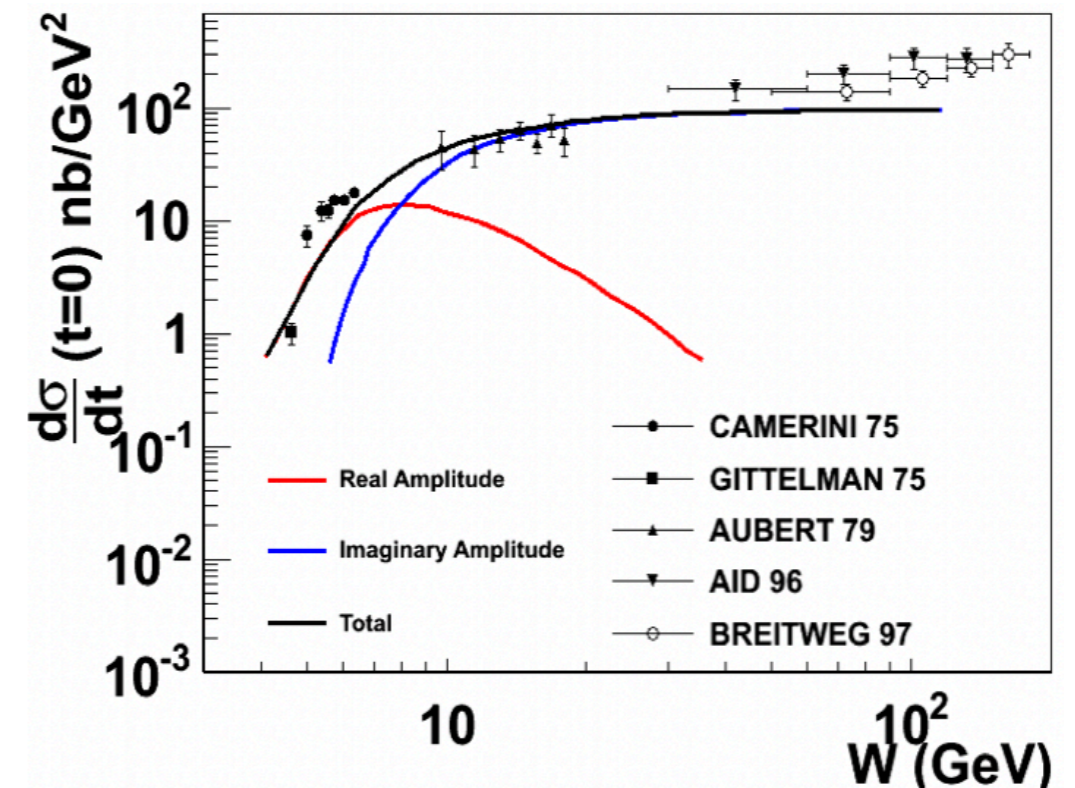

D. Kharzeev, Proc.Int.Sch.Phys.Fermi 130 (1996) 105-131
 D. Kharzeev et al., EPJ-C9 (1999) 459-462

Quarkonium-nucleon scattering amplitude



- ★ VMD relates photo-production cross section to quarkonium-nucleon scattering amplitude $T_{\psi p}$
- Approach works well at **high energies**, constrains $\text{Im}(T_{\psi p})$
- Need $\text{Re}(T_{\psi p})$ to describe threshold region (calculated through dispersion relations)

- ★ $\text{Re}(T_{\psi p})$ dominates near threshold
- ★ Constrained through dispersion relations, not data.

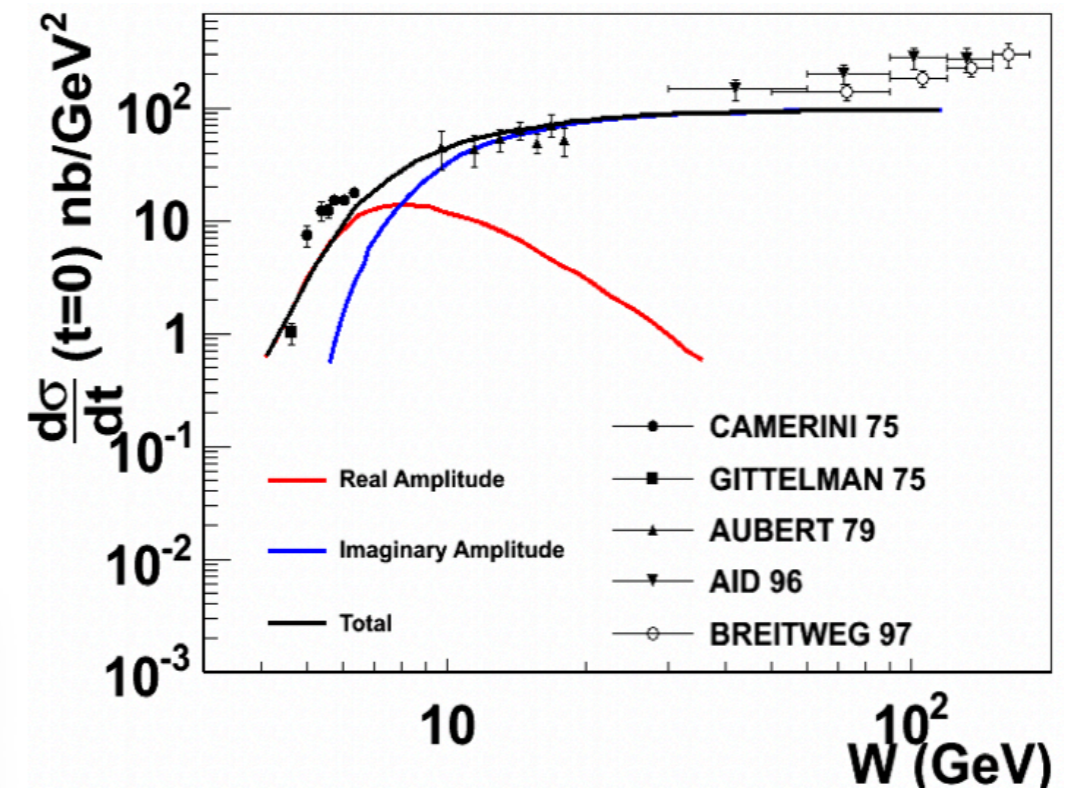

D. Kharzeev, Proc.Int.Sch.Phys.Fermi 130 (1996) 105-131
 D. Kharzeev et al., EPJ-C9 (1999) 459-462

Quarkonium-nucleon scattering amplitude



★ VMD relates photo-production cross section to quarkonium-nucleon scattering amplitude $T_{\psi p}$

★ Works well in recent global fit:

★ $\text{Im}(T_{\psi p})$ from J/ψ and open charm

★ $\text{Re}(T_{\psi p})$ through dispersion relations

O. Gryniuk and M. Vanderhaeghen, *Phys. Rev. D* 94, 074001 (2016)

★ $\text{Re}(T_{\psi p})$ dominates near threshold

★ Constrained through dispersion relations, not data.

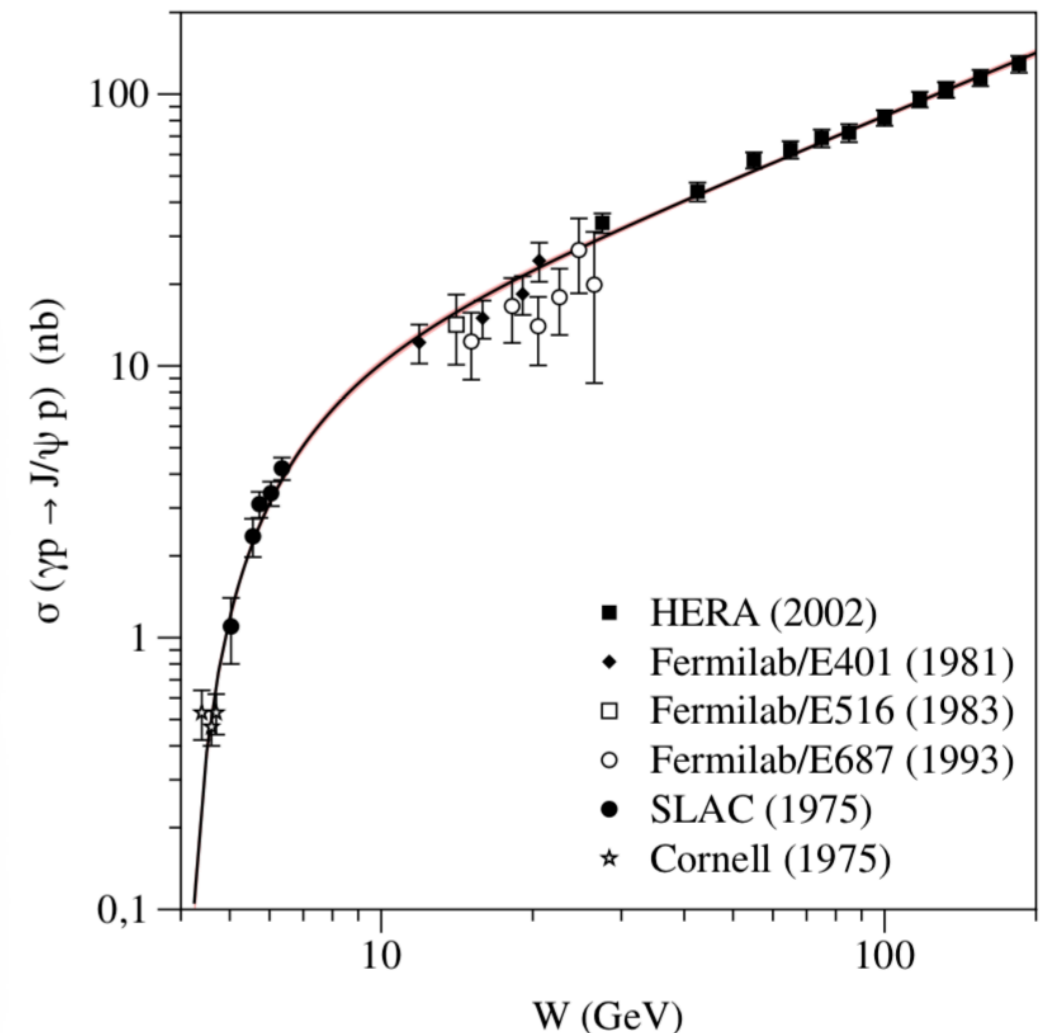

The proton mass is an emergent phenomenon

M. S. Bhagwat *et al.*, Phys. Rev. C 68, 015203 (2003)
I. C. Cloet *et al.*, Prog. Part. Nucl. Phys. 77, 1-69 (2014)

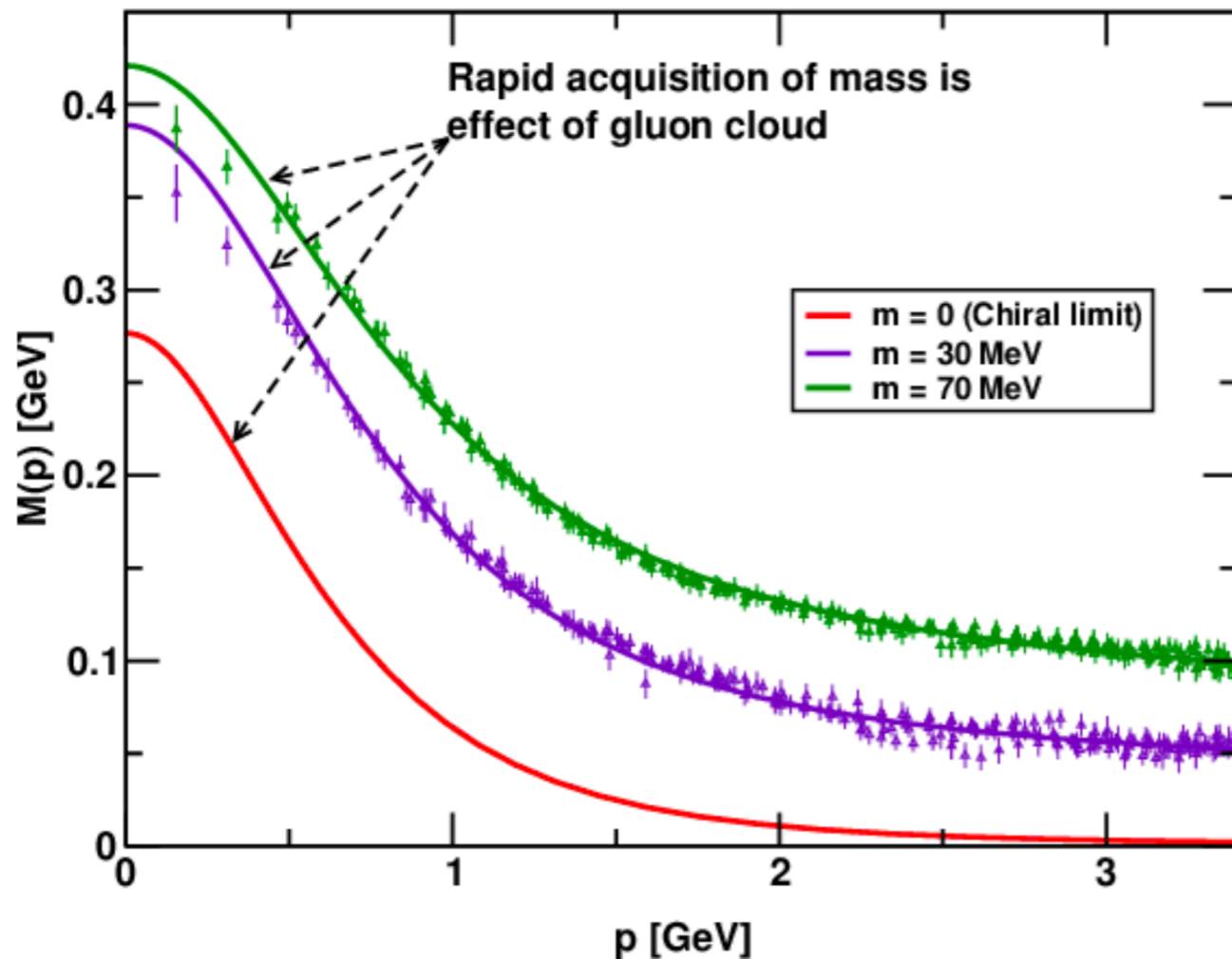

Constituent quark mass from DSE and Lattice

- ☆ Low momentum gluons attach to the current quark (DCSB)
- ☆ **Gluon field accumulates**
 ~ 300 MeV/constituent quark
- ☆ Even in the chiral limit (**mass from nothing**)!

The proton mass is an emergent phenomenon

M. S. Bhagwat *et al.*, Phys. Rev. C 68, 015203 (2003)
I. C. Cloet *et al.*, Prog. Part. Nucl. Phys. 77, 1-69 (2014)

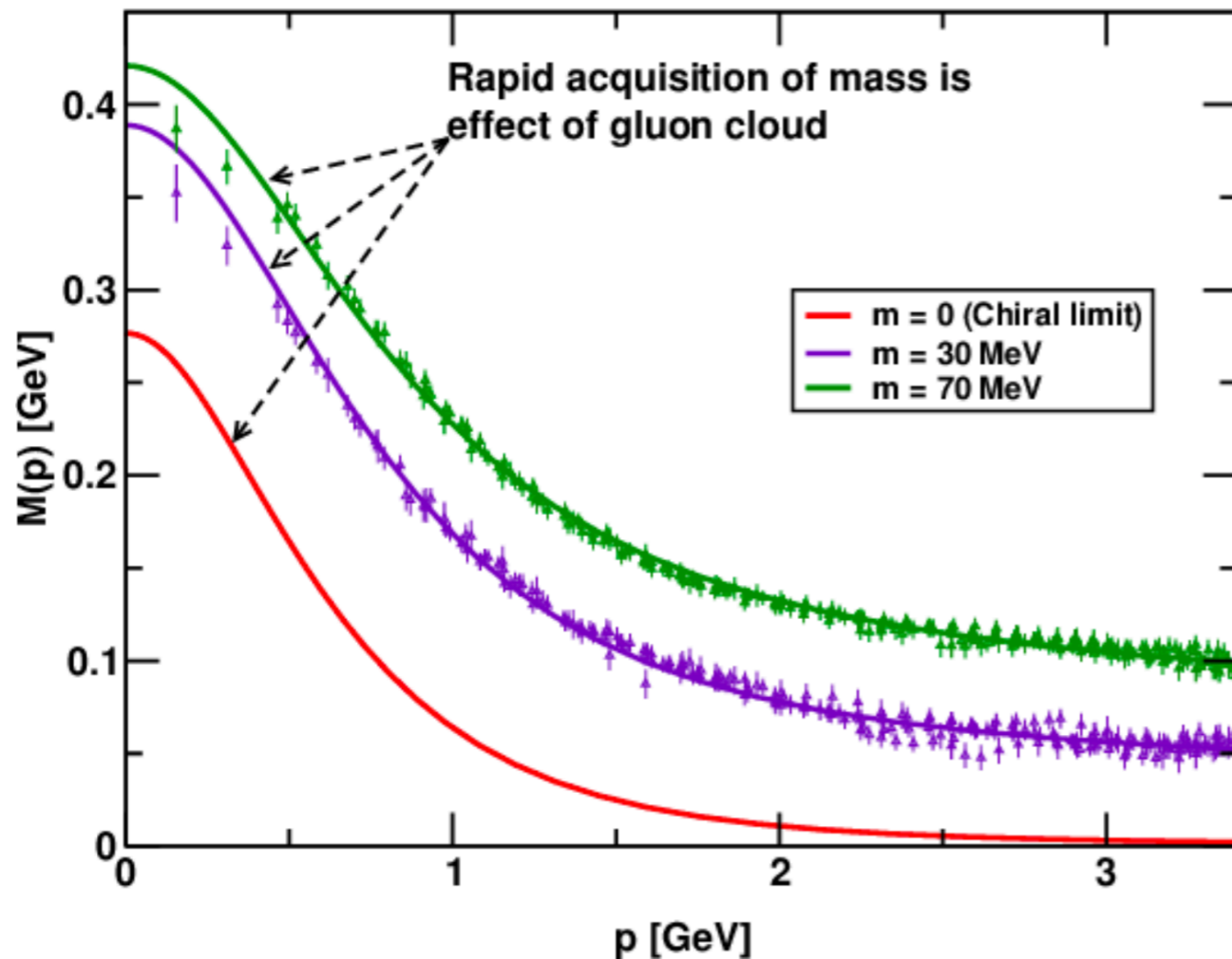

Constituent quark mass from DSE and Lattice

- ★ Low momentum gluons attach to the current quark (DCSB)
- ★ **Gluon field accumulates**
 ~ 300 MeV/constituent quark
- ★ Even in the chiral limit (**mass from nothing**)!

★ **The Higgs mechanism is largely irrelevant in “normal” matter!**

The proton mass: covariant decomposition

D. Kharzeev, Proc.Int.Sch.Phys.Fermi 130 (1996) 105-131

- ☆ Access **nucleon mass through trace of energy-momentum tensor (EMT)** at zero momentum transfer

$$\langle P | T_{\mu}^{\mu} | P \rangle = 2P^{\mu} P_{\mu} = 2M_p^2$$

The proton mass: covariant decomposition

D. Kharzeev, Proc.Int.Sch.Phys.Fermi 130 (1996) 105-131

- ☆ Access **nucleon mass through trace of energy-momentum tensor (EMT)** at zero momentum transfer

$$\langle P | T_{\mu}^{\mu} | P \rangle = 2P^{\mu} P_{\mu} = 2M_p^2$$

- ☆ At low momentum transfer: heavy quarks decouple

$$T_{\mu}^{\mu} = \frac{\tilde{\beta}(g)}{2g} G^2 + \sum_{q=u,d,s} m_q (1 + \gamma_m) \bar{\psi}_q \psi_q$$

Trace Anomaly

Light Quark Mass

The proton mass: covariant decomposition

D. Kharzeev, Proc.Int.Sch.Phys.Fermi 130 (1996) 105-131

- ★ Access **nucleon mass through trace of energy-momentum tensor (EMT)** at zero momentum transfer

$$\langle P | T_{\mu}^{\mu} | P \rangle = 2P^{\mu} P_{\mu} = 2M_p^2$$

- ★ At low momentum transfer: heavy quarks decouple

$$T_{\mu}^{\mu} = \underbrace{\frac{\tilde{\beta}(g)}{2g} G^2}_{\text{Trace Anomaly}} + \underbrace{\sum_{q=u,d,s} m_q (1 + \gamma_m) \bar{\psi}_q \psi_q}_{\text{Light Quark Mass}}$$

Trace Anomaly

Light Quark Mass

- ★ **Trace anomaly term dominant:**
“Proton mass result of the vacuum polarization induced by the presence of the proton.”

The proton mass: covariant decomposition

D. Kharzeev, Proc.Int.Sch.Phys.Fermi 130 (1996) 105-131

- ★ Access **nucleon mass through trace of energy-momentum tensor (EMT)** at zero momentum transfer

$$\langle P | T_{\mu}^{\mu} | P \rangle = 2P^{\mu} P_{\mu} = 2M_p^2$$

- ★ At low momentum transfer: heavy quarks decouple

$$T_{\mu}^{\mu} = \underbrace{\frac{\tilde{\beta}(g)}{2g} G^2}_{\text{Trace Anomaly}} + \underbrace{\sum_{q=u,d,s} m_q (1 + \gamma_m) \bar{\psi}_q \psi_q}_{\text{Light Quark Mass}}$$

Trace Anomaly

Light Quark Mass

- ★ **Experimental access:**

M. Luke *et al.*, PLB 288 (1992) 355-359

- ★ Trace of EMT proportional to **quarkonium-proton scattering amplitude** $T_{\psi p}$

- ★ **Lattice QCD:**

- ★ Possible to evaluate $\langle G^2 \rangle$ directly

The proton mass: rest-frame decomposition

X. Ji, PRL 74, 1071 (1995) & PRD 52, 271 (1995)

- ★ Matrix element of the **QCD Hamiltonian in the rest frame** gives the proton mass

$$H_{\text{QCD}} = \int d^3x T^{00}(0, \vec{x})$$

$$= \underbrace{H_q}_{\text{green}} + \underbrace{H_m}_{\text{red}} + \underbrace{H_g}_{\text{orange}} + \underbrace{H_a}_{\text{blue}}$$

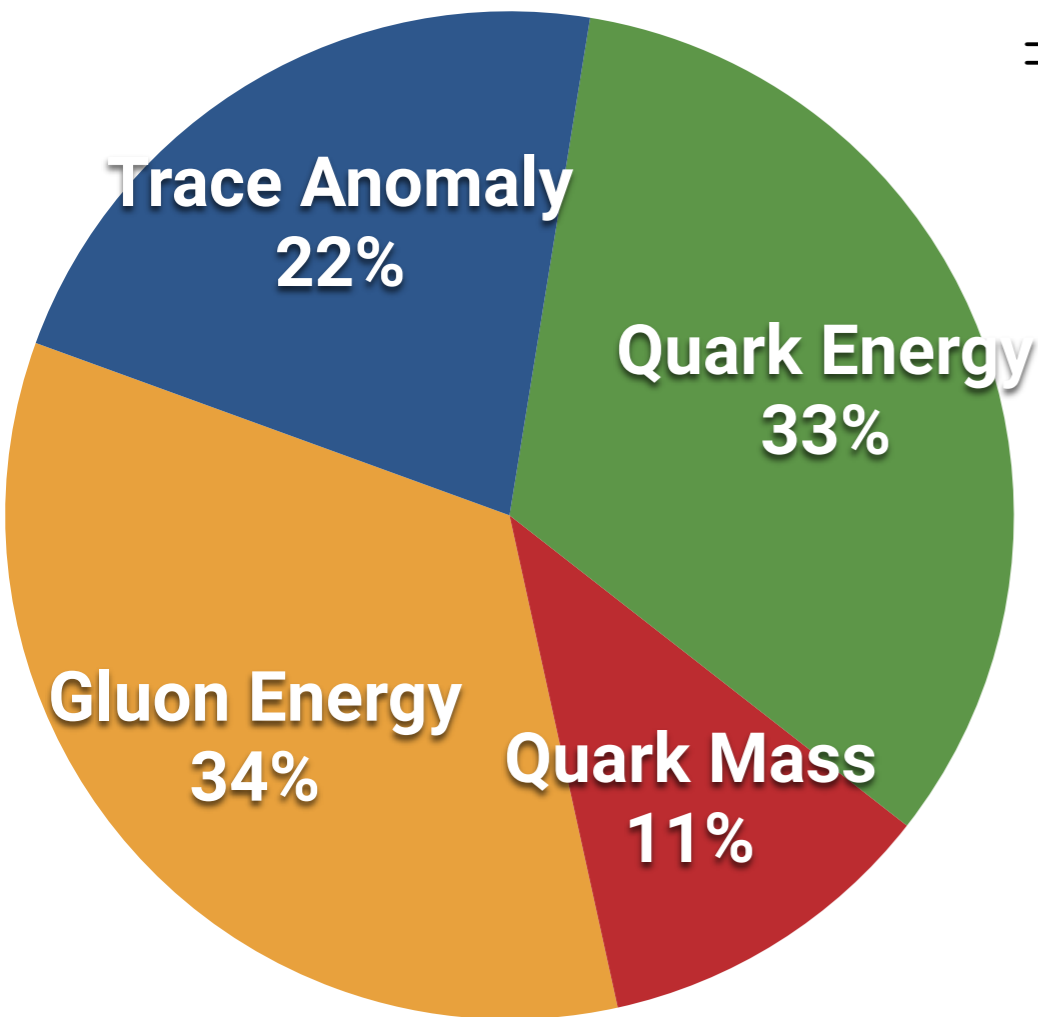

- ★ In leading order:

$$\underbrace{M_q}_{\text{green}} = \frac{3}{4} \left(a - \frac{b}{1 + \gamma_m} \right) M$$

$$\underbrace{M_m}_{\text{red}} = \frac{4 + \gamma_m}{4(1 + \gamma_m)} b M$$

$$\underbrace{M_g}_{\text{orange}} = \frac{3}{4} (1 - a) M$$

$$\underbrace{M_a}_{\text{blue}} = \frac{1}{4} (1 - b) M$$

The proton mass: rest-frame decomposition

X. Ji, PRL 74, 1071 (1995) & PRD 52, 271 (1995)

- ★ Matrix element of the **QCD Hamiltonian in the rest frame** gives the proton mass

$$\begin{aligned}
 H_{\text{QCD}} &= \int d^3x T^{00}(0, \vec{x}) \\
 &= \underbrace{H_q}_{\text{green}} + \underbrace{H_m}_{\text{red}} + \underbrace{H_g}_{\text{orange}} + \underbrace{H_a}_{\text{blue}}
 \end{aligned}$$

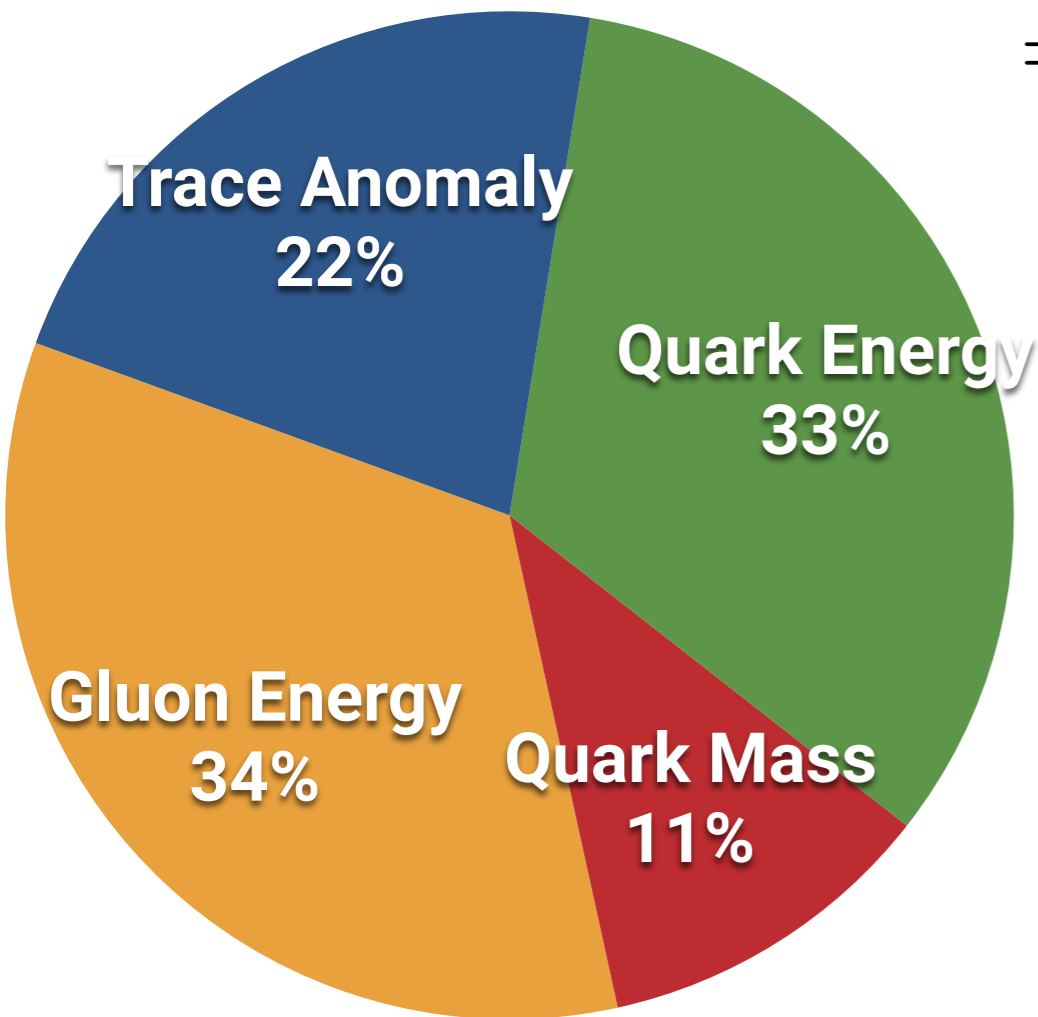

- ★ In leading order:

$$\underbrace{M_q}_{\text{green}} = \frac{3}{4} \left(a - \frac{b}{1 + \gamma_m} \right) M$$

$$\underbrace{M_m}_{\text{red}} = \frac{4 + \gamma_m}{4(1 + \gamma_m)} b M$$

$$\underbrace{M_g}_{\text{orange}} = \frac{3}{4} (1 - a) M$$

$$\underbrace{M_a}_{\text{blue}} = \frac{1}{4} (1 - b) M$$

- ★ $a(\mu)$ related to PDFs, well constrained
- ★ $b(\mu)$ related to quarkonium-proton scattering amplitude $T_{\psi p}$ near-threshold

The proton mass ... a hot topic!

“... The vast majority of the nucleon’s mass is due to quantum fluctuations of quark- antiquark pairs, the gluons, and the energy associated with quarks moving around at close to the speed of light.”

...

(The 2015 Long Range Plan for Nuclear Science)

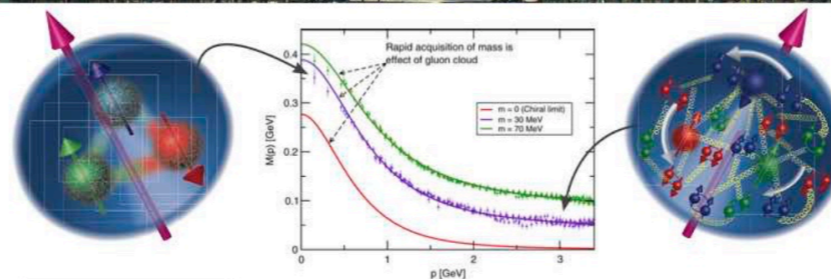

$$M_p = 2m_u^{\text{eff}} + m_d^{\text{eff}}$$

Speakers

- Stan Brodsky (SLAC)
- Xiangdong Ji (Maryland)
- Dima Kharzeev (Stony Brook & BNL)
- Keh-Fei Liu (University of Kentucky)
- David Richards (JLab)
- Craig Roberts (ANL)
- Martin Savage (University of Washington)
- Stepan Stepanyan (JLab)
- George Sterman (Stony Brook)

Moderator

Alfred Mueller (Columbia)

$$H_{\text{QCD}} = H_q + H_m + H_g + H_a$$

Quark kinetic and potential energy $H_q = \int d^3x \psi^\dagger (-i\mathbf{D} \cdot \boldsymbol{\alpha}) \psi$

Quark masses $H_m = \int d^3x \bar{\psi} m \psi$

Gluon kinetic and potential energy $H_g = \int d^3x \frac{1}{2} (\mathbf{E}^2 + \mathbf{B}^2)$

Trace anomaly $H_a = \int d^3x \frac{9\alpha_s}{16\pi} (\mathbf{E}^2 - \mathbf{B}^2)$

Workshop Topics

- Hadron Mass Calculation: Lattice QCD and Other Methods
- Hadron Mass Decomposition



Local Organizers

Zein-Eddine Meziani (Temple U.)
Jianwei Qiu (Brookhaven National Lab)





ECT*

EUROPEAN CENTRE FOR THEORETICAL STUDIES
IN NUCLEAR PHYSICS AND RELATED AREAS
TRENTO, ITALY
Institutional Member of the European Expert Committee NUPECC





Castello di Trento ("Trint"), watercolor 19.8 x 27.7, painted by A. Dürer on his way back from Venice (1495). British Museum, London

The Proton Mass: At the Heart of Most Visible Matter

Trento, April 3 - 7, 2017

Main Topics
Hadron mass decomposition in terms of constituents: Uniqueness of the decomposition, Quark mass, and quark and gluon energy contribution, Anomaly contribution, ...
Hadron mass calculations: Lattice QCD (total & individual mass components), Approximated analytical methods, Phenomenological model approaches, ...
Experimental access to hadron mass components: Exclusive heavy quarkonium production at threshold, nuclear gluonometry through polarized nuclear structure function, ...

Confirmed speakers and participants
Alexandrou Constantia (Cyprus University), Brodsky Stan (SLAC), Burkardt Matthias (New Mexico State University), Chen Jian-Ping (Jefferson Lab), Chudakov Eugene (Jefferson Lab), Cloët Ian (Argonne National Lab), de Teramond Guy (University Costa Rica), Deshpande Abhay (Stony Brook University), Eichmann Gernot (Giessen University), Hafidi Kawtar (Argonne National Lab), Hoellbling Christian (University of Wuppertal), Lin Huey-Wen (Michigan State University), Liu Keh-Fei (University of Kentucky), Loeck Cédric (Ecole Polytechnique, Palaiseau), Mulders Piet (Rijke University of Amsterdam), Papanastasiou Ioannis (Yale University), Pascalisia Vladimir (Johannes Gutenberg University of Mainz), Richards David (Jefferson Lab), Roberts Craig (Argonne National Lab), Sliker Karl (University of New Hampshire), Mauro Anselmino (University of Torino & INFN), Bob Jaffe (Massachusetts Institute of Technology), Dima Kharzeev (Stony Brook University), Xiangdong Ji (University of Maryland).

Organizers
Zein-Eddine Meziani (Temple University)
Barbara Pasquini (University of Pavia)
Jianwei Qiu (Jefferson Lab)
Marc Vanderhaeghen (Universität Mainz)

Director of the ECT*: Professor Jochen Wambach (ECT*)

The ECT* is sponsored by the "Fondazione Bruno Kessler" in collaboration with the "Assessorato alla Cultura" (Provincia Autonoma di Trento), funding agencies of EU Member and Associated States and has the support of the Department of Physics of the University of Trento.

For local organization please contact: Gianmaria Ziglio - ECT* Secretariat - Villa Tambosi - Strada delle Tabarelle 286 - 38123 Villazano - Trento - Italy
Tel.:(+39-0461) 314721 Fax:(+39-0461) 314750, E-mail: ect@ectstar.eu or visit <http://www.ectstar.eu>

The proton mass ... a hot topic!

“... The vast majority of the nucleon’s mass is due to quantum fluctuations of quark- antiquark pairs, the gluons, and the energy associated with quarks moving around at close to the speed of light.”

(The 2015 Long Range Plan for Nuclear Science)

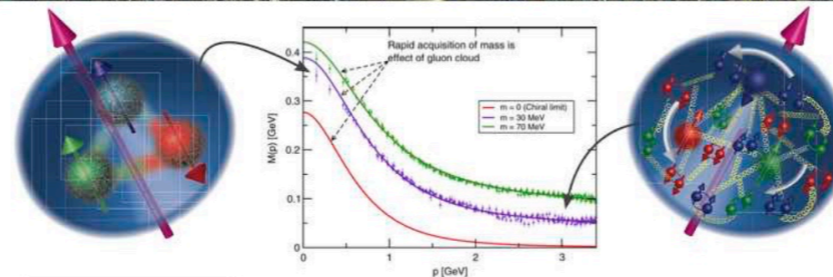
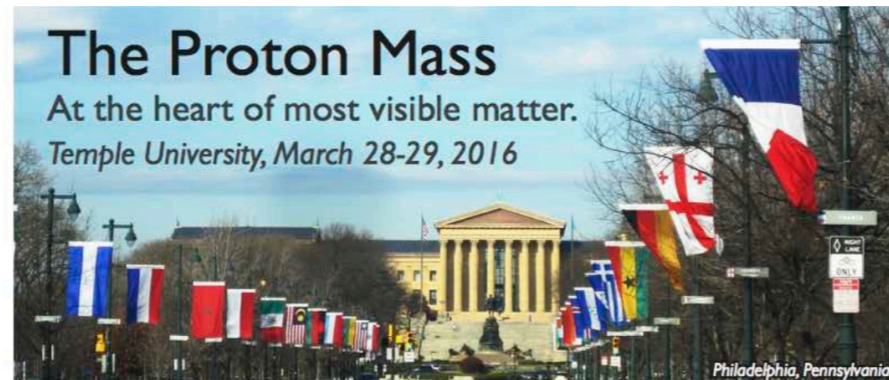

$$M_p = 2m_u^{\text{eff}} + m_d^{\text{eff}}$$

Speakers

- Stan Brodsky (SLAC)
- Xiangdong Ji (Maryland)
- Dima Kharzeev (Stony Brook & BNL)
- Keh-Fei Liu (University of Kentucky)
- David Richards (JLab)
- Craig Roberts (ANL)
- Martin Savage (University of Washington)
- Stepan Stepanyan (JLab)
- George Sterman (Stony Brook)

Moderator

Alfred Mueller (Columbia)

$$H_{\text{QCD}} = H_q + H_m + H_g + H_a$$

Quark kinetic and potential energy $H_q = \int d^3x \psi^\dagger (-i\mathbf{D} \cdot \boldsymbol{\alpha}) \psi$

Quark masses $H_m = \int d^3x \bar{\psi} m \psi$

Gluon kinetic and potential energy $H_g = \int d^3x \frac{1}{2} (\mathbf{E}^2 + \mathbf{B}^2)$

Trace anomaly $H_a = \int d^3x \frac{9\alpha_s}{16\pi} (\mathbf{E}^2 - \mathbf{B}^2)$

Workshop Topics

- Hadron Mass Calculation: Lattice QCD and Other Methods
- Hadron Mass Decomposition

Local Organizers

Zein-Eddine Meziani (Temple U)
Jianwei Qiu (Brookhaven National Lab)





ECT*

EUROPEAN CENTRE FOR THEORETICAL STUDIES
IN NUCLEAR PHYSICS AND RELATED AREAS
TRENTO, ITALY
Institutional Member of the European Expert Committee NUPECC





Castello di Trento ("Trin"), watercolor 19.8 x 27.7, painted by A. Dürer on his way back from Venice (1495). British Museum, London

The Proton Mass: At the Heart of Most Visible Matter

Trento, April 3 - 7, 2017

Main Topics
Hadron mass decomposition in terms of constituents: Uniqueness of the decomposition, Quark mass, and quark and gluon energy contribution, Anomaly contribution, ...
Hadron mass calculations: Lattice QCD (total & individual mass components), Approximated analytical methods, Phenomenological model approaches, ...
Experimental access to hadron mass components: Exclusive heavy quarkonium production at threshold, nuclear gluonometry through polarized nuclear structure function, ...

Confirmed speakers and participants
Alexandrou Constantia (Cyprus University), Brodsky Stan (SLAC), Burkardt Matthias (New Mexico State University), Chen Jian-Ping (Jefferson Lab), Chudakov Eugene (Jefferson Lab), Cloët Ian (Argonne National Lab), de Teramond Guy (University Costa Rica), Deshpande Abhay (Stony Brook University), Eichmann Gernot (Giessen University), Hafidi Kawtar (Argonne National Lab), Hoellbling Christian (University of Wuppertal), Lin Huey-Wen (Michigan State University), Liu Keh-Fei (University of Kentucky), Loeck Cedric (Ecole Polytechnique, Palaiseau), Mulders Piet (Rijke University of Amsterdam), Papanastasiou Ioannis (Yale University), Pascalisia Vladimir (Johannes Gutenberg University of Mainz), Richards David (Jefferson Lab), Roberts Craig (Argonne National Lab), Sliker Karl (University of New Hampshire), Mauro Anselmino (University of Torino & INFN), Bob Jaffe (Massachusetts Institute of Technology), Dima Kharzeev (Stony Brook University), Xiangdong Ji (University of Maryland).

Organizers
Zein-Eddine Meziani (Temple University)
Barbara Pasquini (University of Pavia)
Jianwei Qiu (Jefferson Lab)
Marc Vanderhaeghen (Universität Mainz)

Director of the ECT*: Professor Jochen Wambach (ECT*)

The ECT* is sponsored by the "Fondazione Bruno Kessler" in collaboration with the "Assessorato alla Cultura" (Provincia Autonoma di Trento), funding agencies of EU Member and Associated States and has the support of the Department of Physics of the University of Trento.

For local organization please contact: Gianmaria Ziglio - ECT* Secretariat - Villa Tambosi - Strada delle Tabarelle 286 - 38123 Villazano - Trento - Italy
Tel.:(+39-0461) 314721 Fax:(+39-0461) 314750, E-mail: ect@ectstar.eu or visit http://www.ectstar.eu

JLab will play a leading role:
Access trace anomaly through elastic
 J/ψ production near threshold

Binding energy of the J/ψ - nucleon potential

- ☆ Color neutral objects:
gluonic Van der Waals force
- ☆ **At threshold**, spin-averaged scattering amplitude related to **s-wave scattering length $a_{\psi p}$**
$$T_{\psi p} = 8\pi(M + M_{\psi})a_{\psi p}$$
- ☆ **Binding $B_{\psi p}$** can be **derived from $a_{\psi p}$**

Binding energy of the J/ψ - nucleon potential

- ☆ Color neutral objects:
gluonic Van der Waals force
- ☆ **At threshold**, spin-averaged scattering amplitude related to **s-wave scattering length $a_{\psi p}$**

$$T_{\psi p} = 8\pi(M + M_{\psi})a_{\psi p}$$

- ☆ **Binding $B_{\psi p}$** can be **derived from $a_{\psi p}$**
- ☆ Estimates between 0.05-0.30 fm, corresponding to $B_{\psi p} < 20$ MeV
- ☆ LQCD: $B_{\psi p} < 40$ MeV
S. R. Beane *et al.*, Phys. Rev. D 91, 114503 (2015)
- ☆ Recent fit to existing data in a dispersive framework:
 - ☆ $a_{\psi p} \sim 0.05$ fm ($B_{\psi p} \sim 3$ MeV)
O. Gryniuk and M. Vanderhaeghen, Phys. Rev. D 94, 074001 (2016)

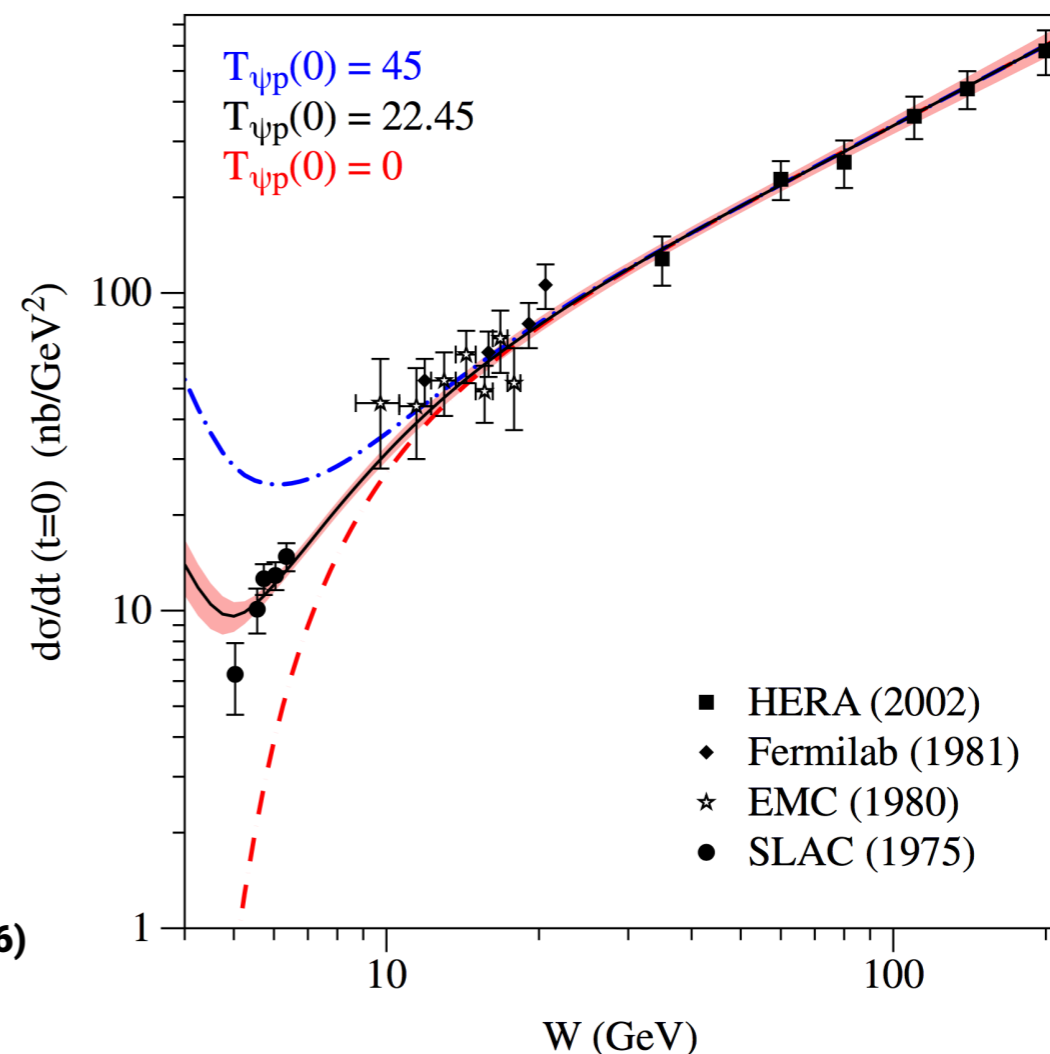

Binding energy of the J/ψ - nucleon potential

- ☆ Color neutral objects:
gluonic Van der Waals force
- ☆ **At threshold**, spin-averaged scattering amplitude related to **s-wave scattering length $a_{\psi p}$**

$$T_{\psi p} = 8\pi(M + M_{\psi})a_{\psi p}$$

- ☆ **Binding $B_{\psi p}$** can be **derived from $a_{\psi p}$**

- ☆ Estimates between 0.05-0.30 fm, corresponding to $B_{\psi p} < 20$ MeV

- ☆ LQCD: $B_{\psi p} < 40$ MeV

S. R. Beane *et al.*, Phys. Rev. D 91, 114503 (2015)

- ☆ Recent fit to existing data in a dispersive framework:

- ☆ $a_{\psi p} \sim 0.05$ fm ($B_{\psi p} \sim 3$ MeV)

O. Gryniuk and M. Vanderhaeghen, Phys. Rev. D 94, 074001 (2016)

- ☆ Photo-production near threshold constrained through dispersion relations, not data
- ☆ **Threshold experiments needed!**

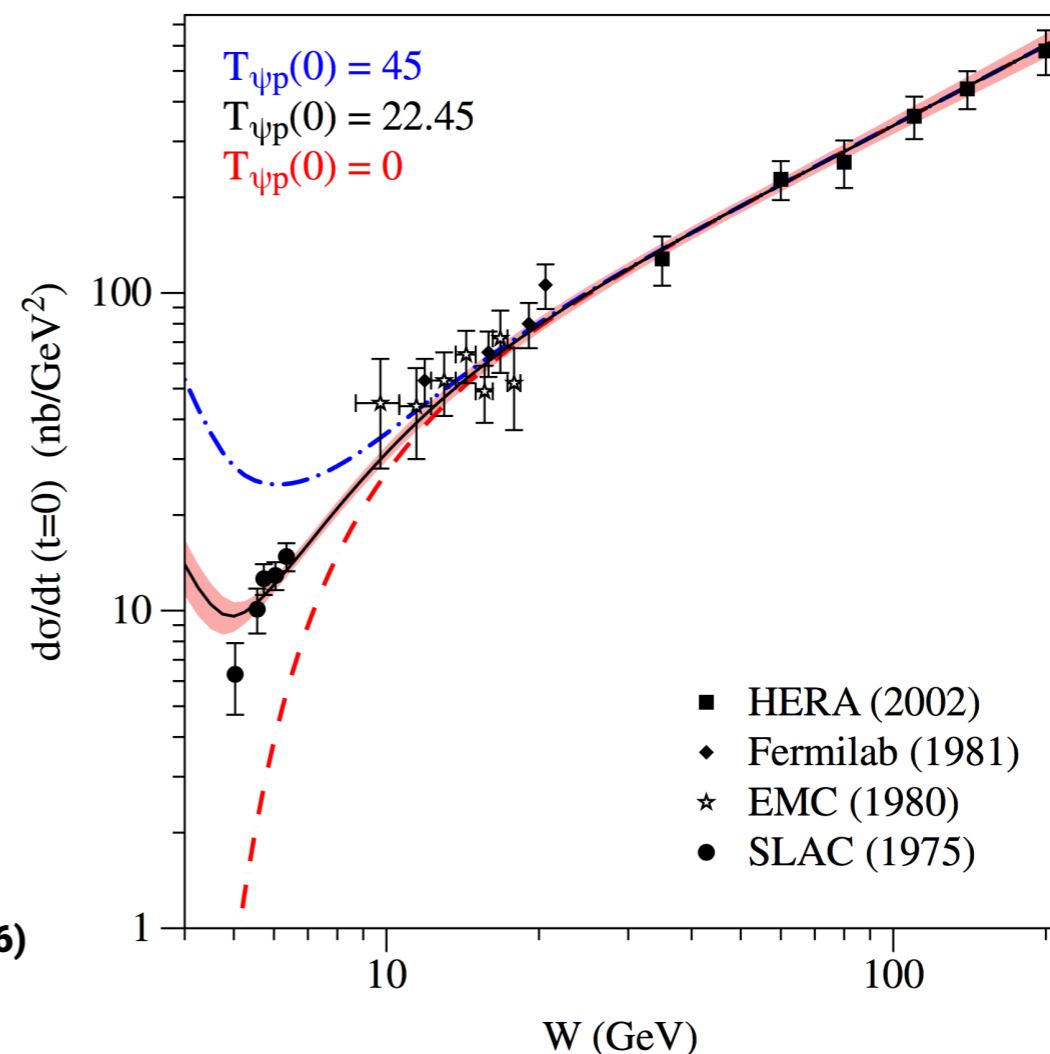

B-H asymmetry: access scattering length $a_{\psi p}$

- ☆ **Interference** between elastic J/ψ production near threshold and **Bethe-Heitler**
- ☆ **Forward-backward asymmetry** near the J/ψ invariant mass peak
- ☆ Sensitive to real part of the scattering amplitude, hence $a_{\psi p}$ and $B_{\psi p}$

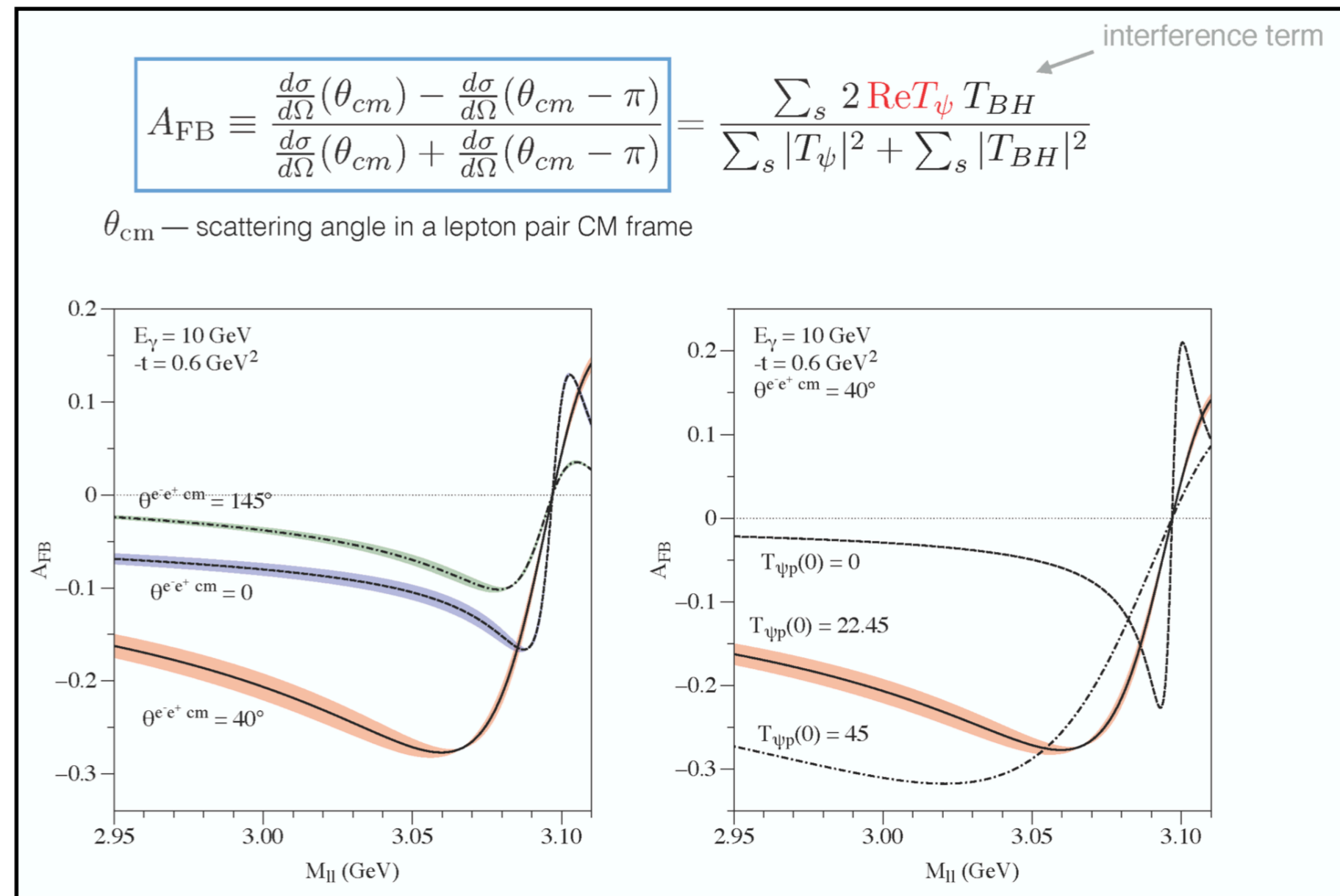
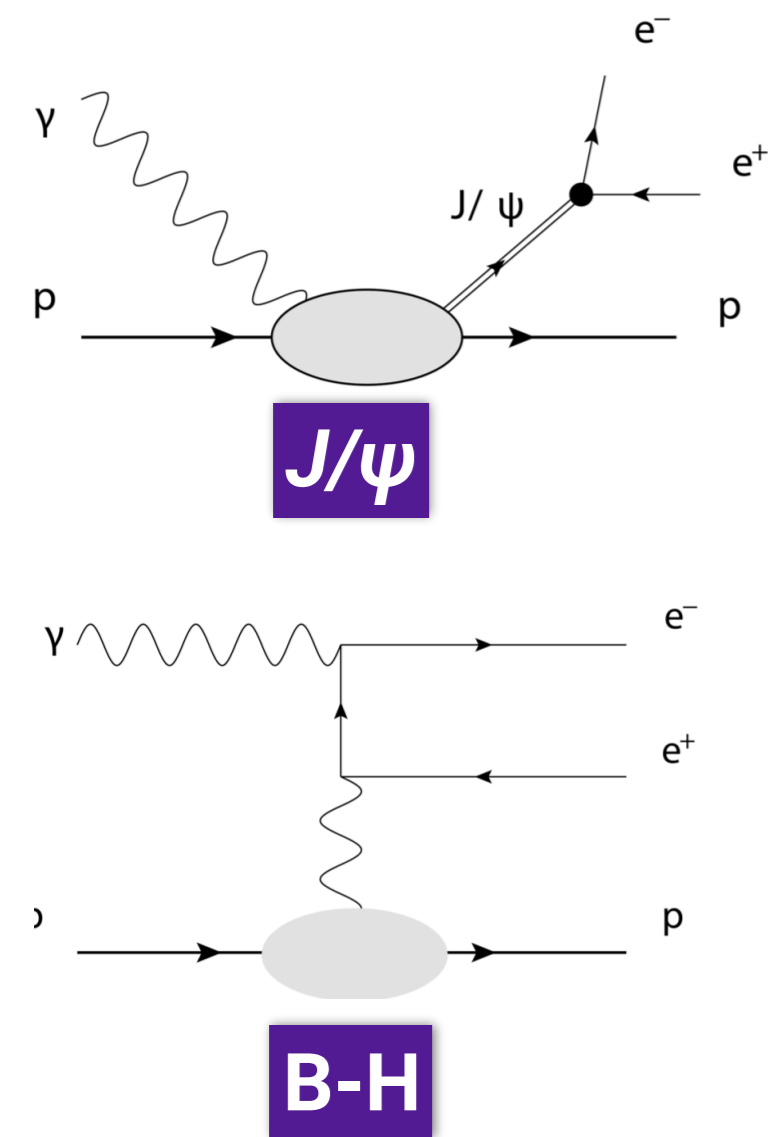

charmed "pentaquark" in photo-production

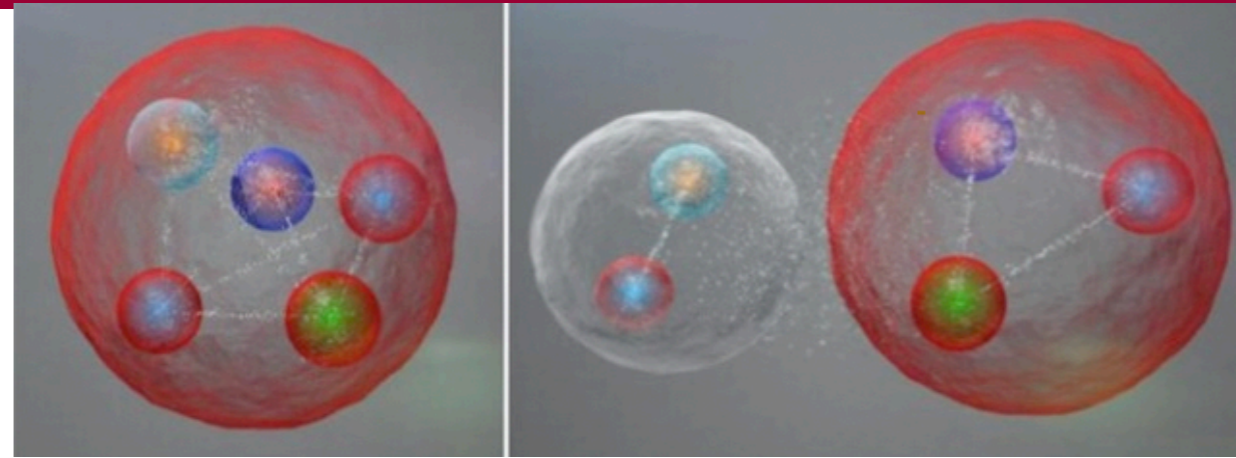
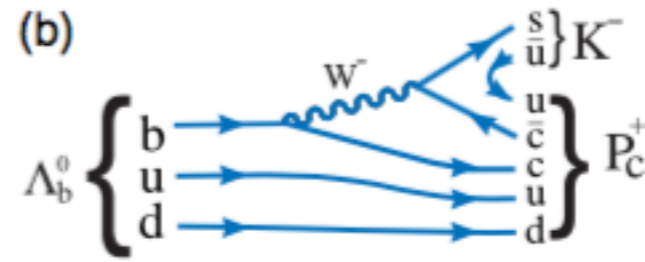
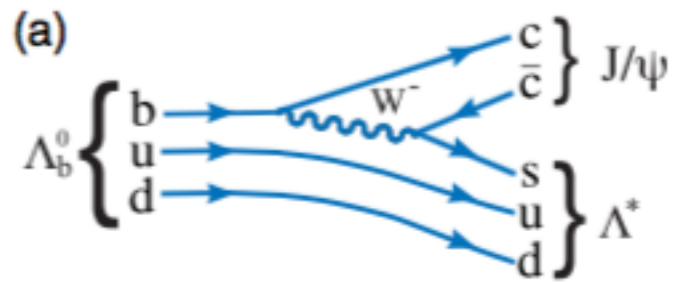

charmed “pentaquark” in photo-production

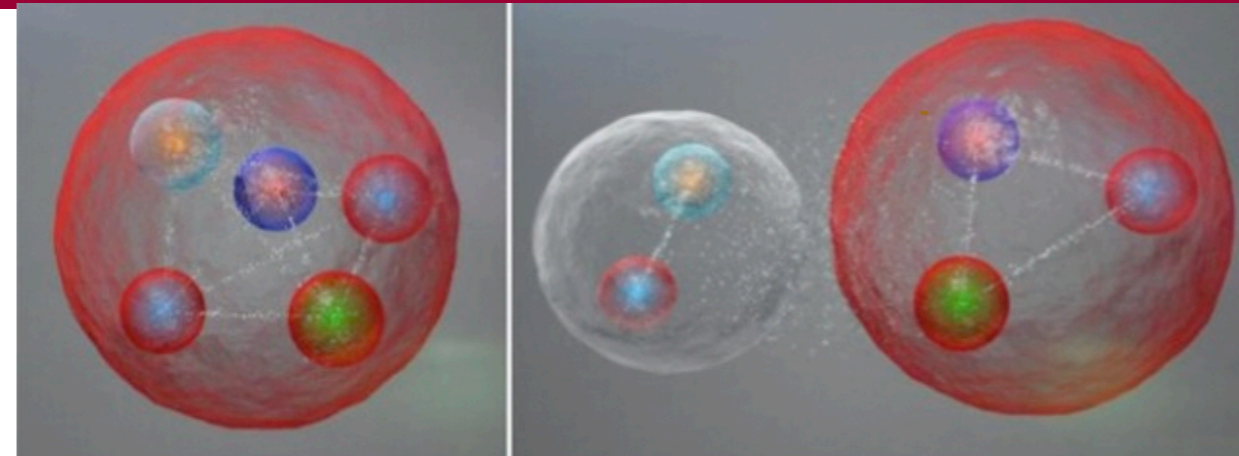
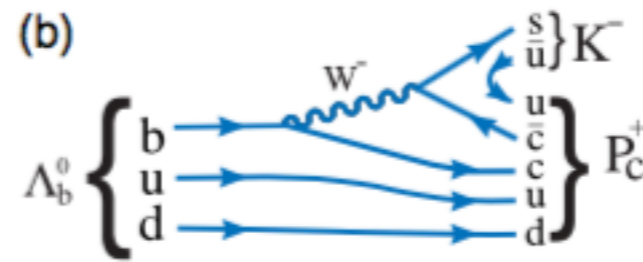
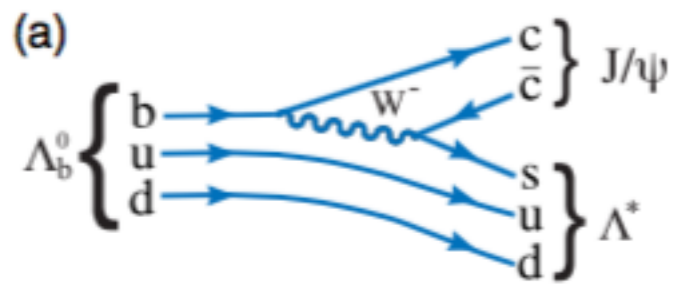

- Possible explanations for LHCb observations:
 - ★ **LHCb**: 2 new **charmed “pentaquark”** (P_c) states
 - ★ **alternative: kinematic enhancements** through anomalous triangle singularity (**ATS**)

Lui X-H, et al., PLB 757 (2016), p231
(and references therein)

charmed “pentaquark” in photo-production

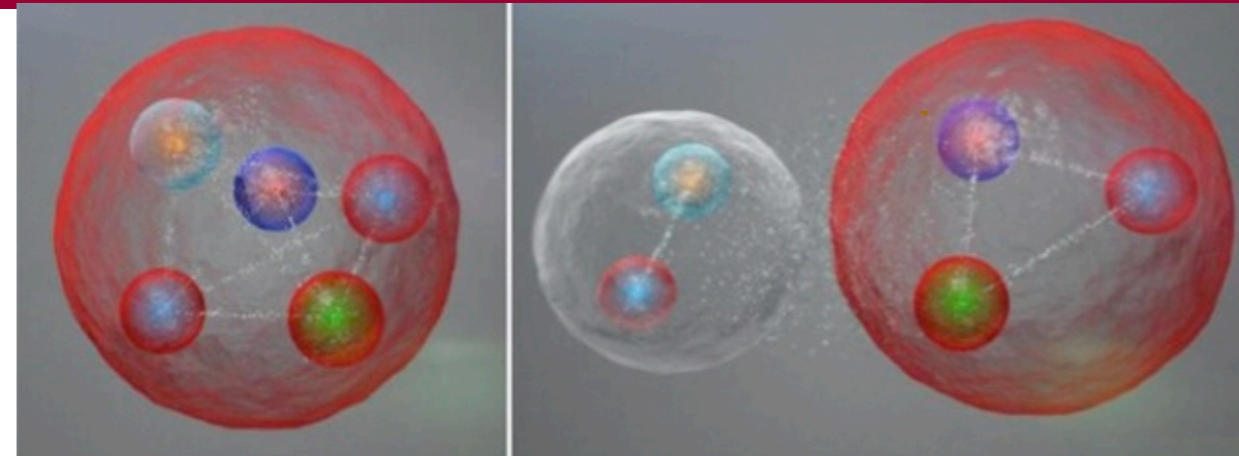
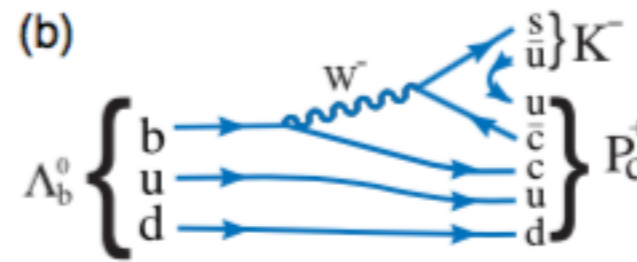
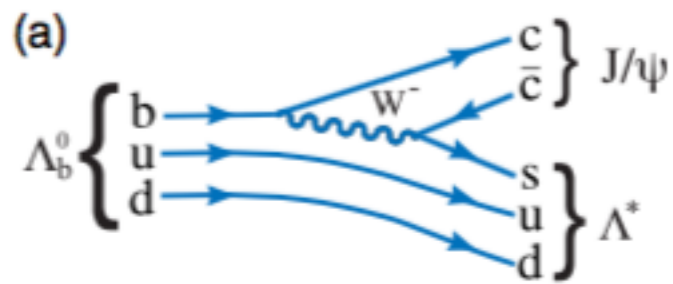

Possible explanations for LHCb observations:

★ **LHCb**: 2 new charmed “pentaquark” (P_c) states

★ **alternative: kinematic enhancements** through anomalous triangle singularity (**ATS**)

Lui X-H, *et al.*, PLB 757 (2016), p231
(and references therein)

★ **Photo-production** ideal tool to **distinguish** between both explanations

★ if P_c real states, **also created in photo-production**

★ kinematic enhancement through **ATS not possible**

Wang Q., *et al.*, PRD 92-3 (2015) 034022
(and references therein)

charmed “pentaquark” in photo-production

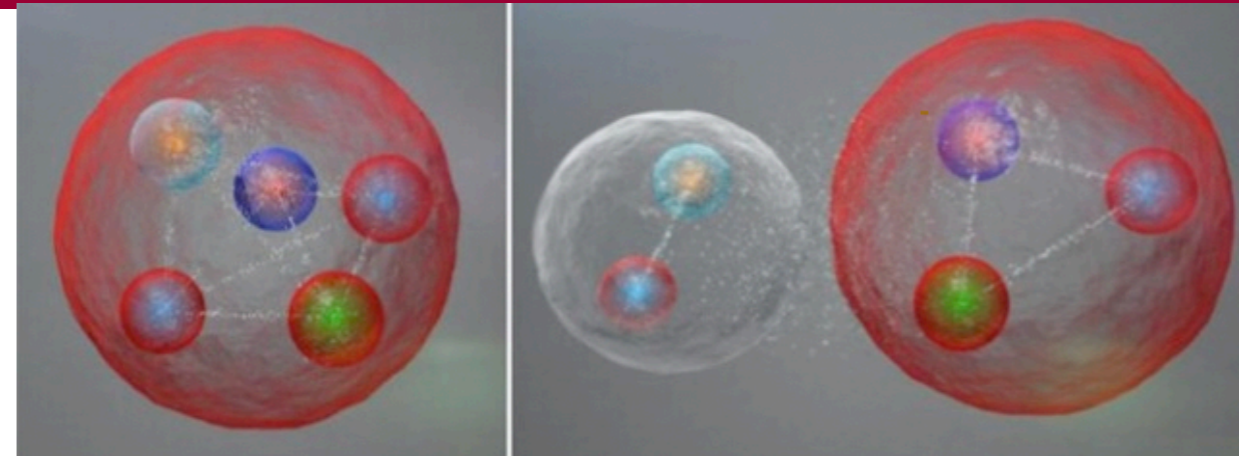
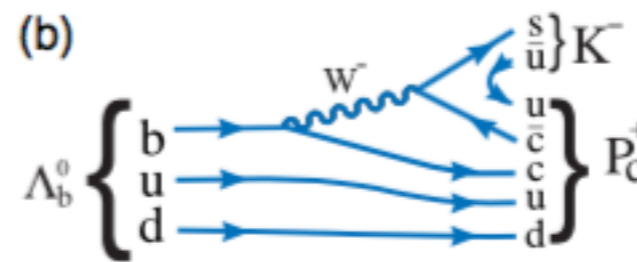
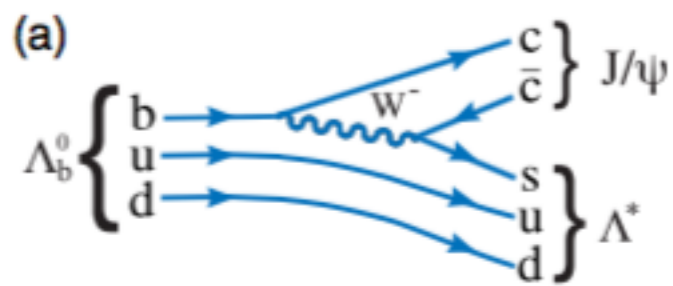

- Possible explanations for LHCb observations:

- ★ **LHCb**: 2 new charmed “pentaquark” (P_c) states

- ★ **alternative: kinematic enhancements** through anomalous triangle singularity (**ATS**)

Lui X-H, et al., PLB 757 (2016), p231
(and references therein)

- Photo-production** ideal tool to **distinguish** between both explanations

- ★ if P_c real states, **also created in photo-production**

- ★ kinematic enhancement through **ATS not possible**

Wang Q., et al., PRD 92-3 (2015) 034022
(and references therein)

- $P_c(4450)$ translates to **narrow peak around $E_\gamma = 10$ GeV**

JLab perfect place for this measurement!

J/ψ at JLab in **the 12GeV era**



- ☆ CEBAF: High-luminosity continuous electron beam
- ☆ 4 Experimental Halls
- ☆ 11GeV at Hall A, B and C
- ☆ 12GeV at Hall D

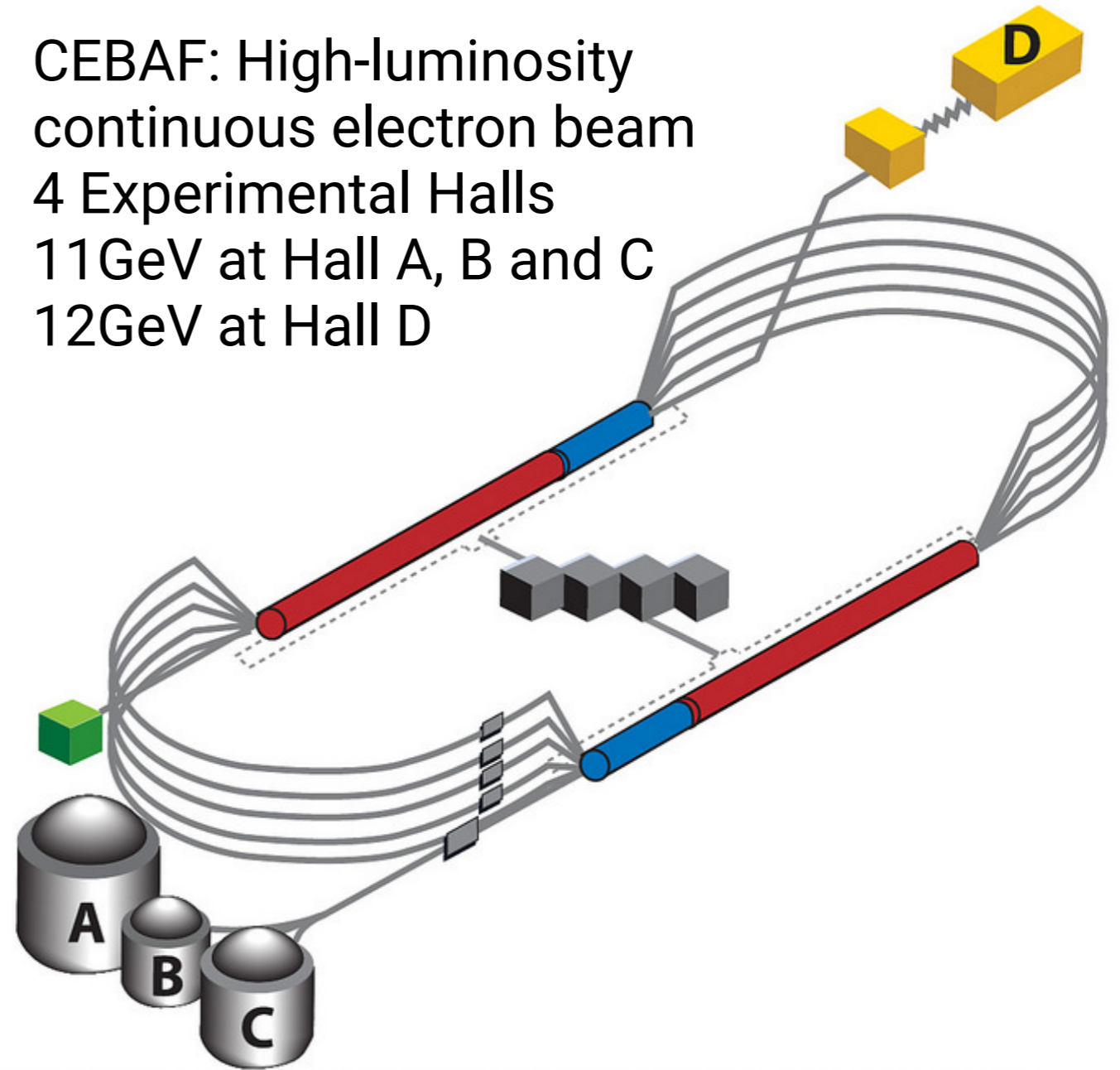

JLab is the ideal laboratory to measure J/ψ near threshold, due to luminosity, resolution and energy reach!

J/ψ in Hall D/GlueX

First J/ψ at JLab!

Expected daily yield: $\sim 5-10 J/\psi$

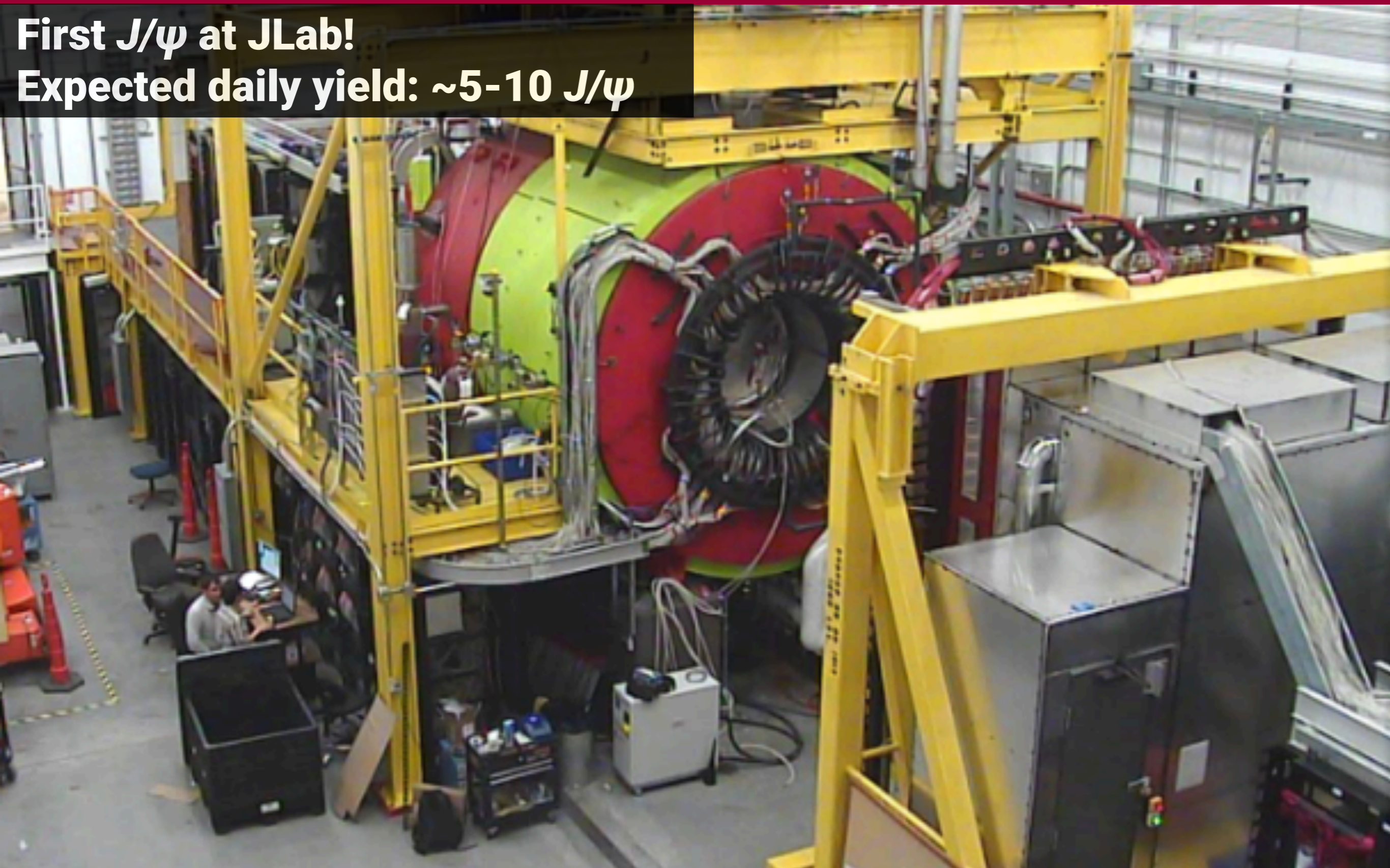

J/ψ experiment E12-12-001 in Hall B/CLAS12

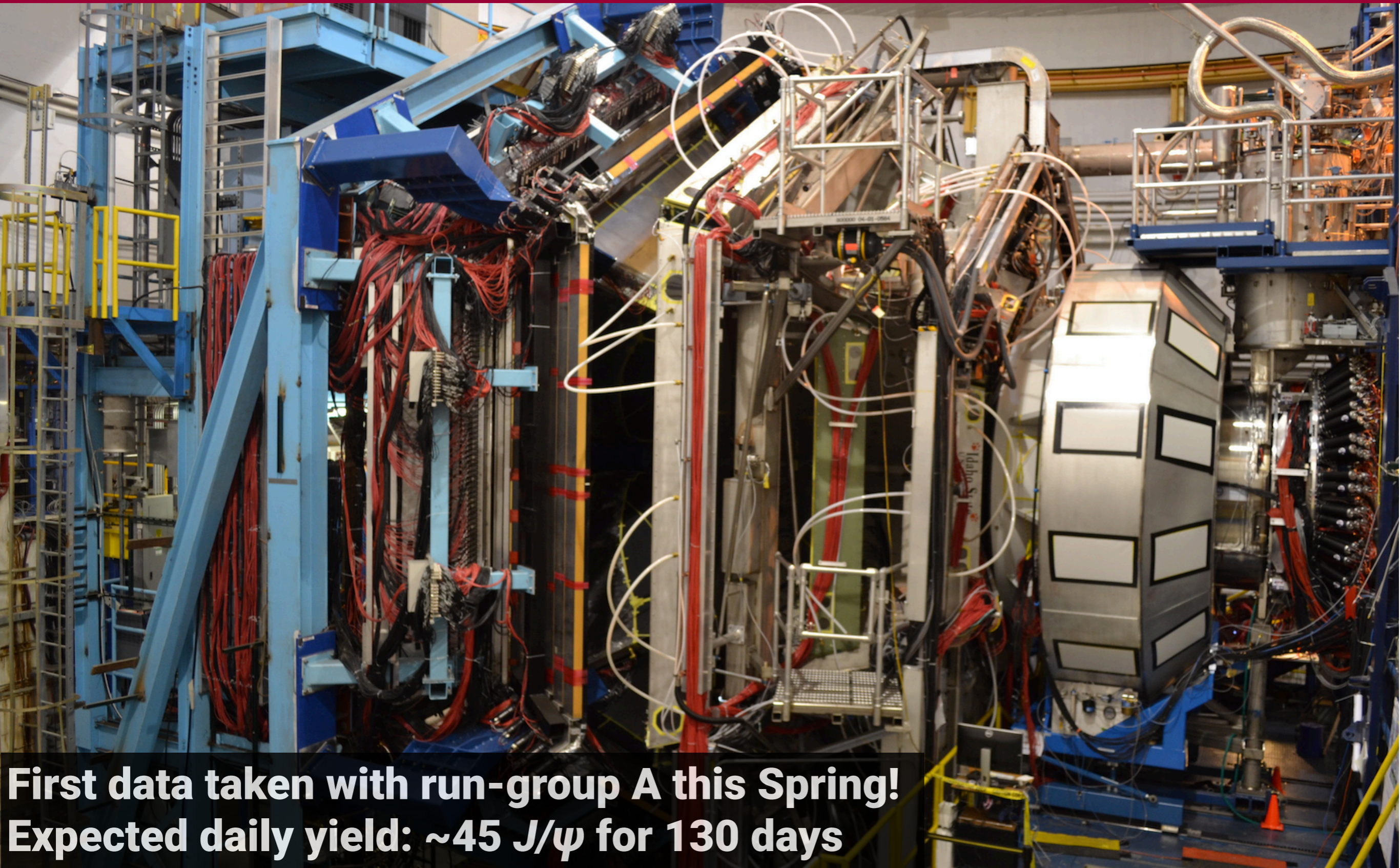

**First data taken with run-group A this Spring!
Expected daily yield: $\sim 45 J/\psi$ for 130 days**

Pentaquark search E12-16-007 in Hall C

$J/\psi-007$

- ☆ 50 μ A electron beam at 10.6 GeV for **11 days**
- ☆ 9% copper radiator
- ☆ 15cm **liquid hydrogen target**
- ☆ **total 10% RL**
- ☆ Detect J/ψ decay leptons in coincidence
 - ☆ Bremsstrahlung photon energy fully constrained

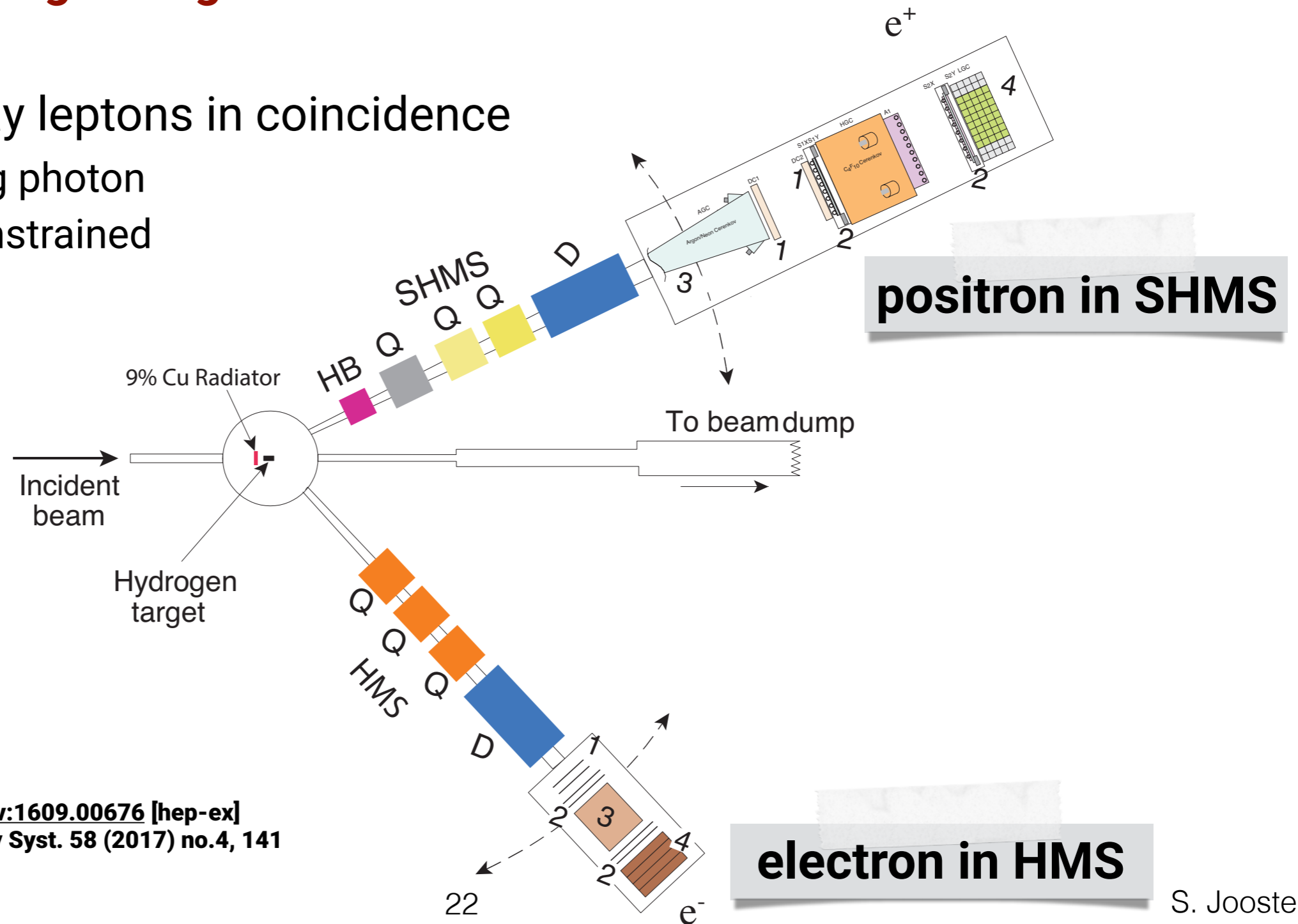

Z.-E. Meziani, S. Joosten *et al.*, [arXiv:1609.00676](https://arxiv.org/abs/1609.00676) [hep-ex]
K. Hafidi, S. Joosten *et al.*, *Few Body Syst.* 58 (2017) no.4, 141

Pentaquark search E12-16-007 in Hall C

$J/\psi-007$

- ☆ 50 μ A electron beam at 10.6 GeV for **11 days**
- ☆ 9% copper radiator
- ☆ 15cm **liquid hydrogen target**
- ☆ **total 10% RL**
- ☆ Detect J/ψ decay leptons in coincidence
 - ☆ Bremsstrahlung photon energy fully constrained

**High-impact experiment
...will run February 2019!**

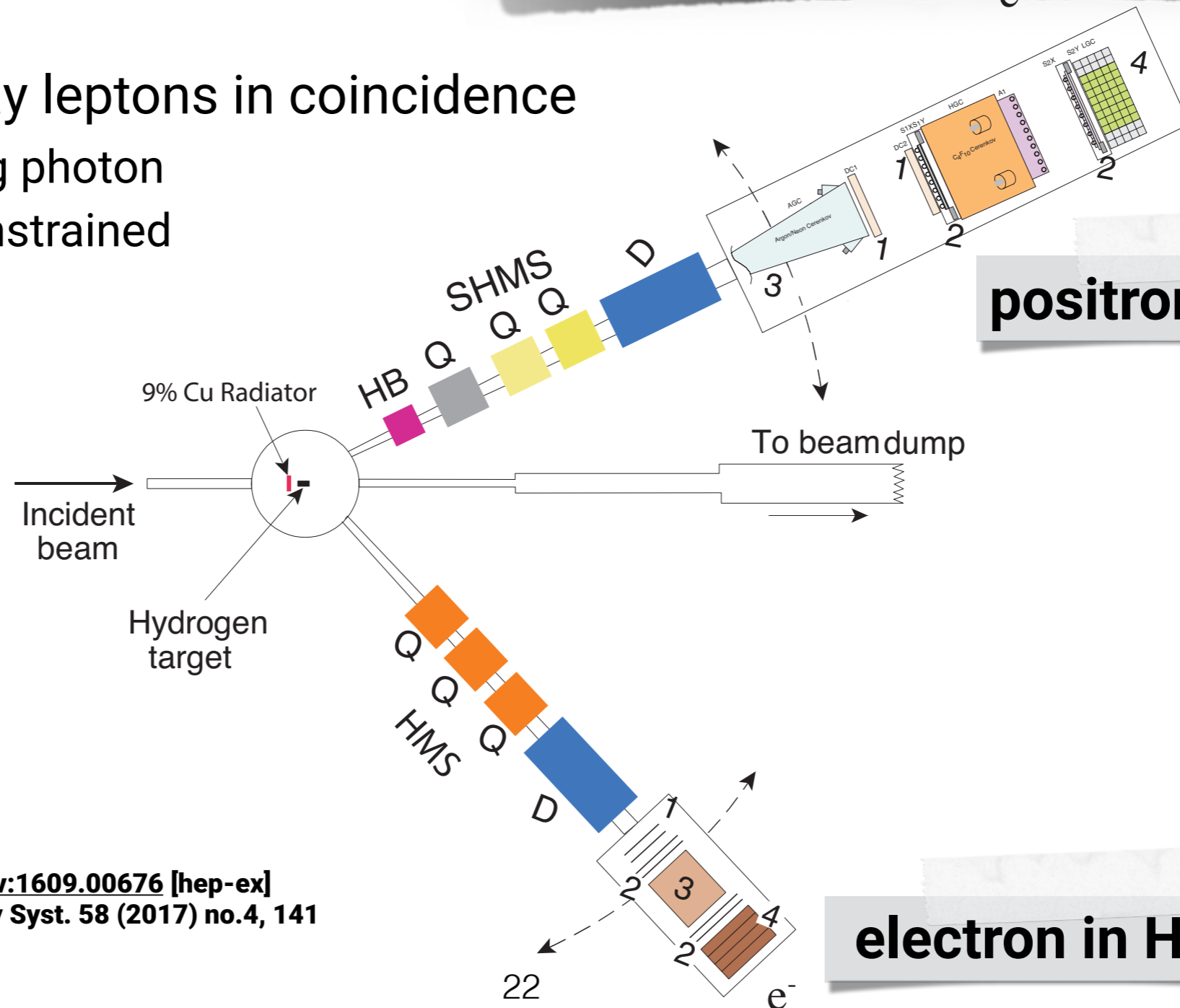

Z.-E. Meziani, S. Joosten *et al.*, [arXiv:1609.00676](https://arxiv.org/abs/1609.00676) [hep-ex]
K. Hafidi, S. Joosten *et al.*, *Few Body Syst.* 58 (2017) no.4, 141

Resonant J/ψ production through P_c decay

$J/\psi - 007^5$

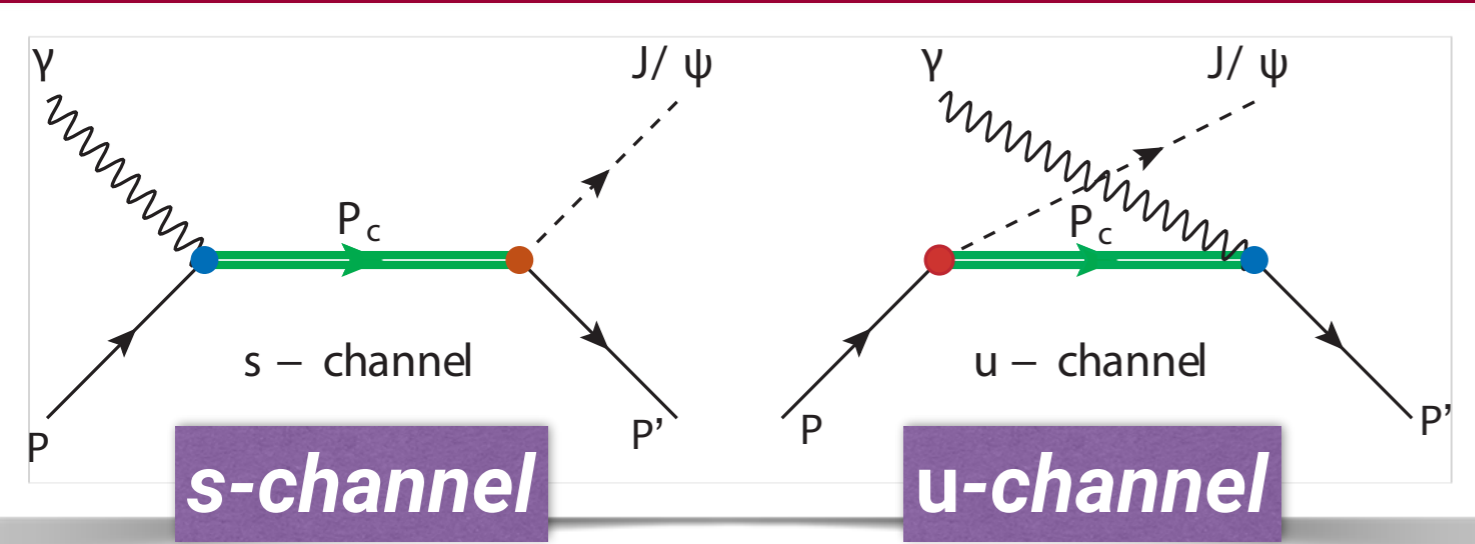

Resonant J/ψ production through P_c decay

$J/\psi - 007^{\sigma}$

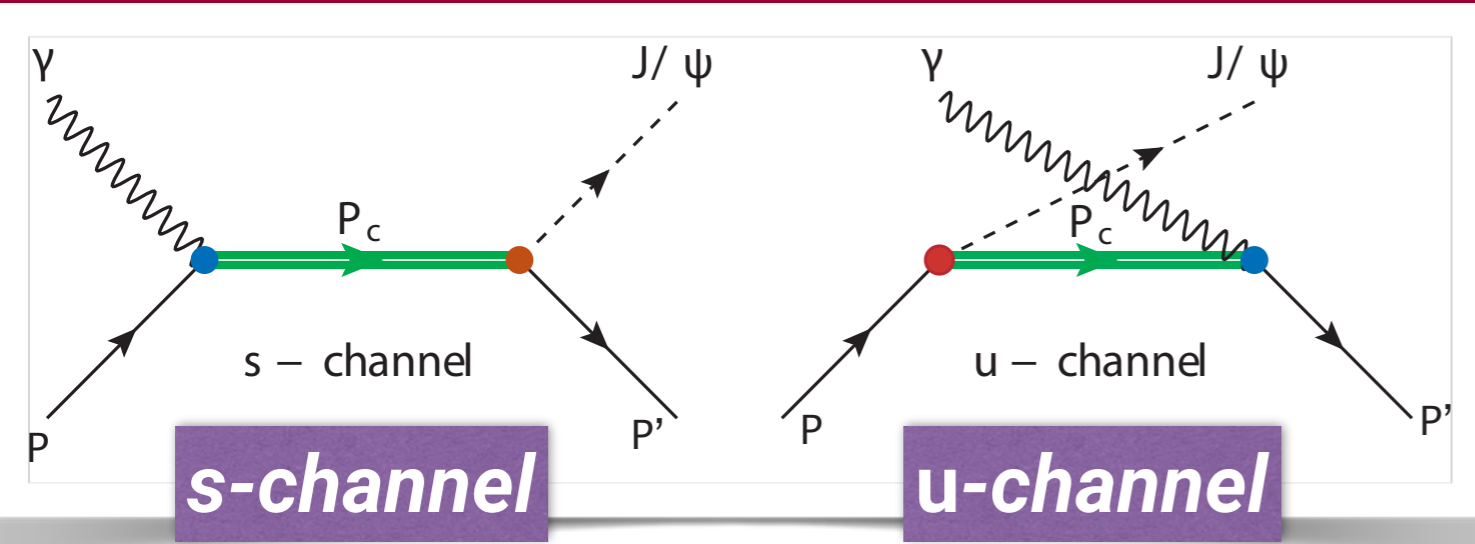

- ★ Cross section depends on **coupling of P_c to $(J/\psi, p)$ channel**

Resonant J/ψ production through P_c decay

$J/\psi - 007$

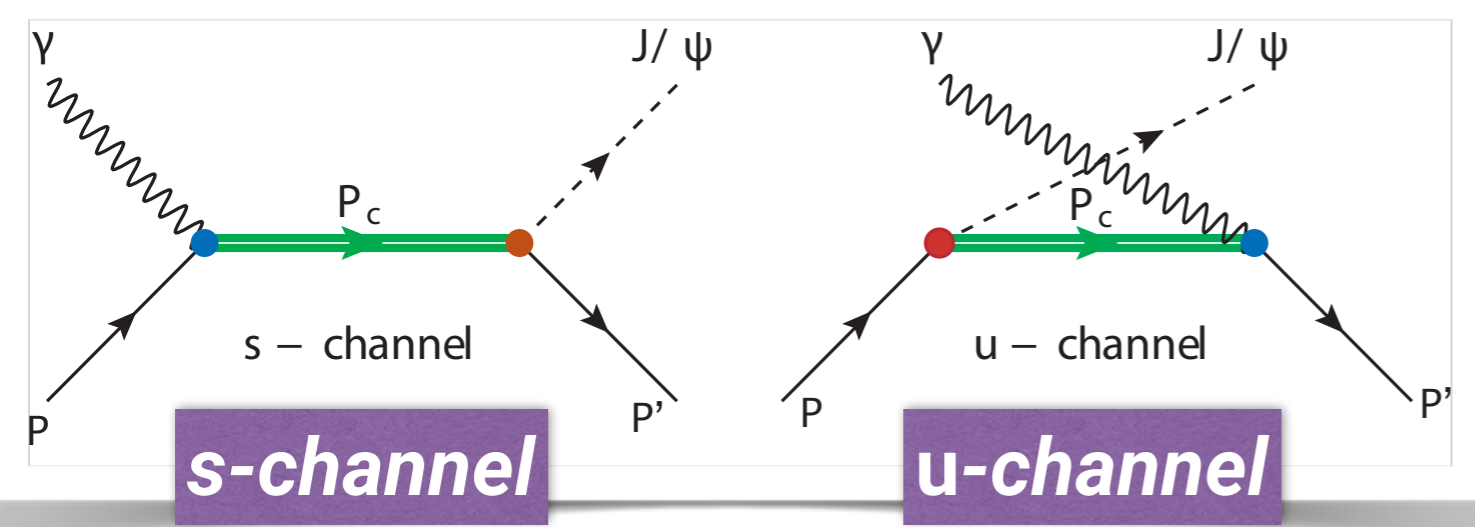

$$\frac{d\sigma}{d\cos\theta_{J/\psi}} (\gamma p \rightarrow P_c \rightarrow J/\psi p)$$

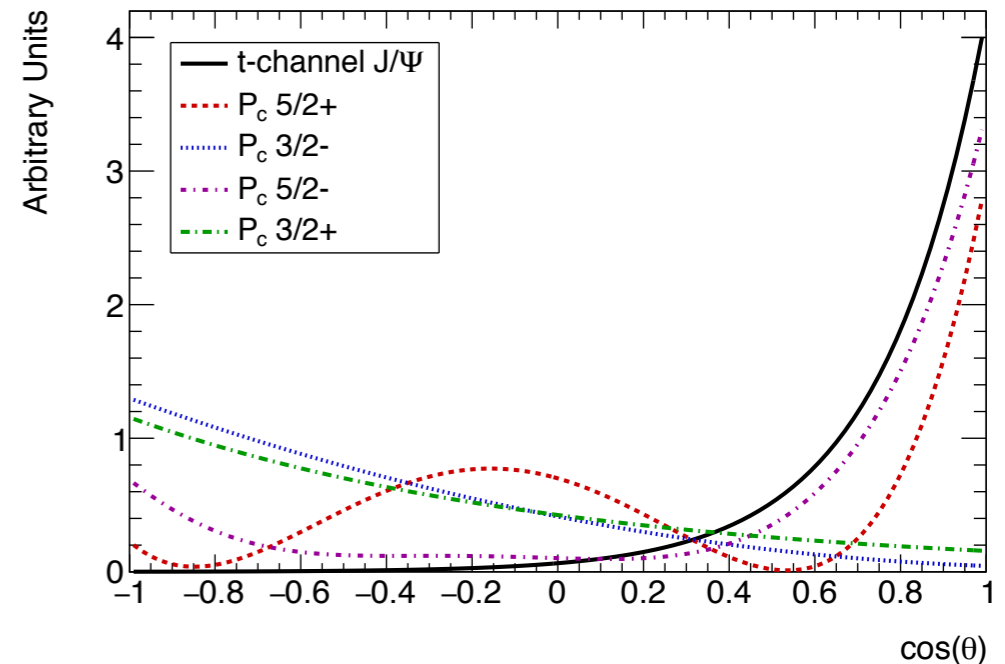

- ★ Cross section depends on **coupling of P_c to $(J/\psi, p)$ channel**
- ★ **J/ψ angular distribution** differs between t -channel and $s(u)$ -channel

Resonant J/ψ production through P_c decay

$J/\psi-007^{\mathcal{F}}$

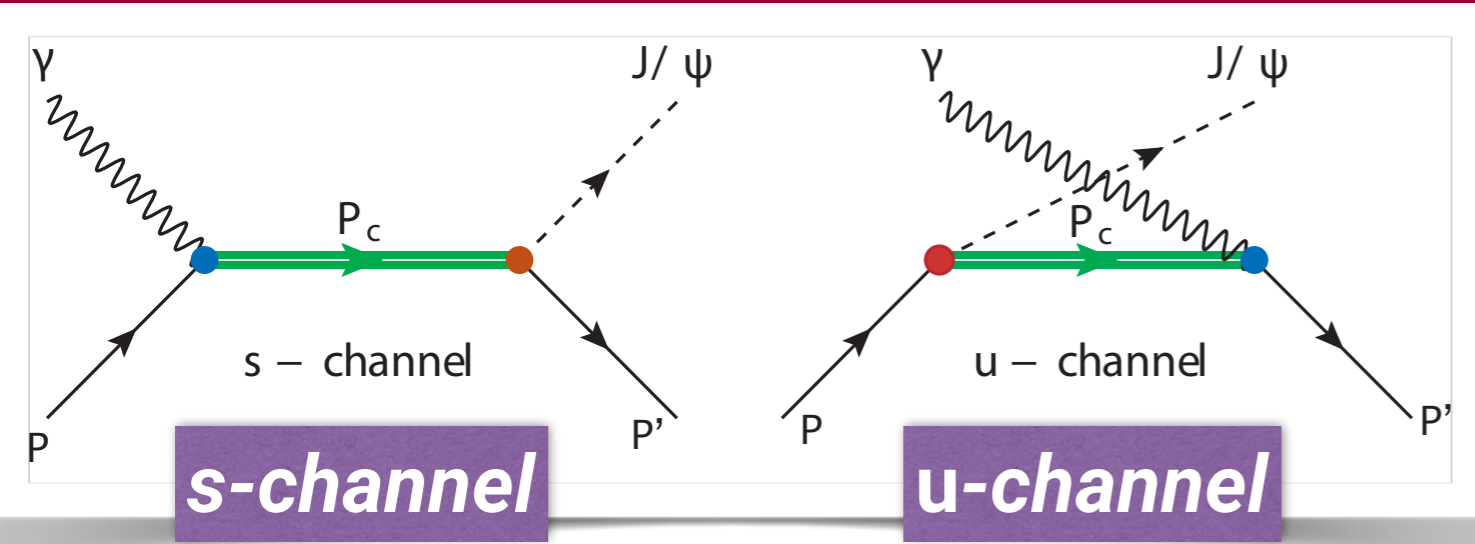

$$\frac{d\sigma}{d\cos\theta_{J/\psi}} (\gamma p \rightarrow P_c \rightarrow J/\psi p)$$

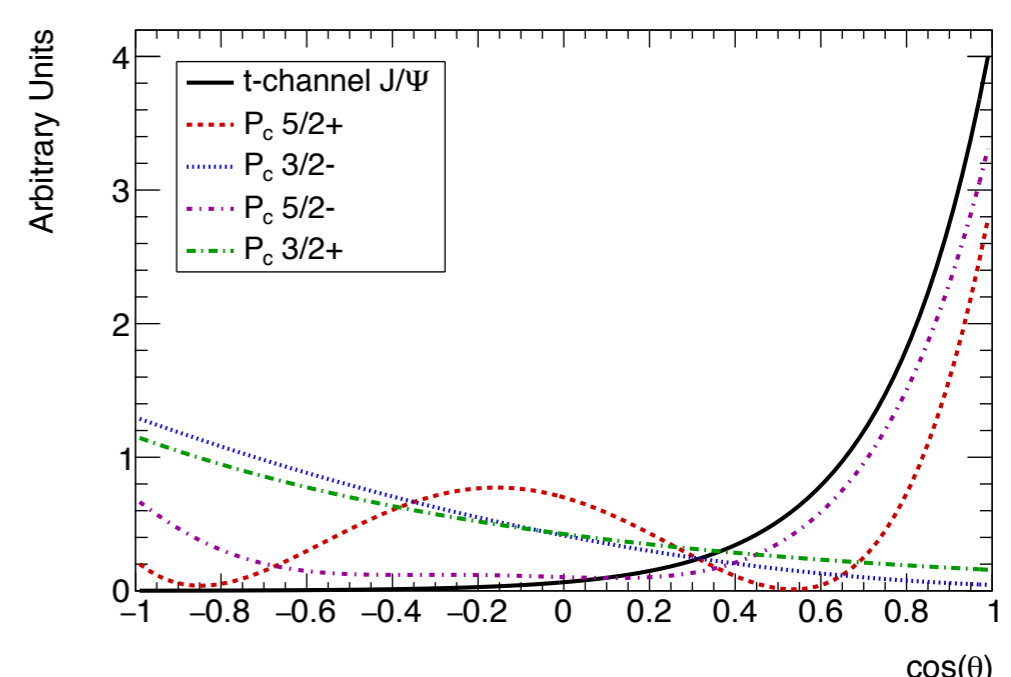

- ★ Cross section depends on **coupling of P_c to $(J/\psi, p)$ channel**
- ★ **J/ψ angular distribution** differs between t -channel and $s(u)$ -channel

Leverage angular dependence to maximize sensitivity at low coupling!

- 2 settings:
 - ★ “**SIGNAL**” (#1) to maximize S/B
 - ★ “**BACKGROUND**” (#2) to precisely determine t -channel J/ψ cross section

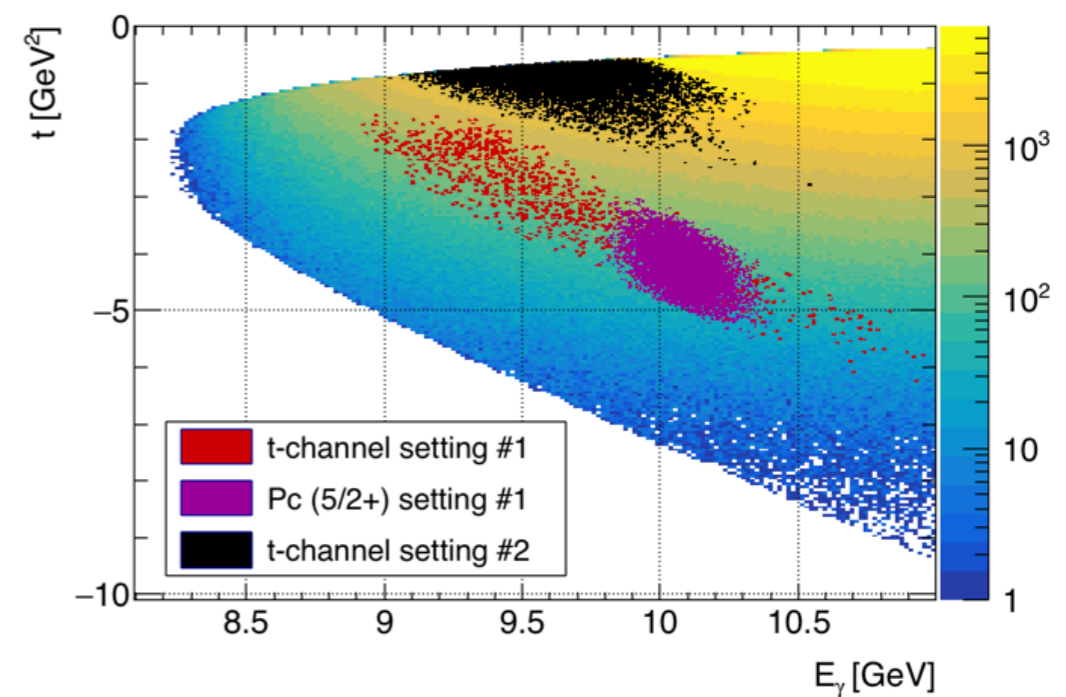

Projected results for P_c search in Hall C

$J/\psi - 007\psi$

- 2+9 days of beam time at $50\mu\text{A}$
- 5/2+ peak dominates the spectrum**
- ☆ 26x reduction in t -channel background rate
- Background measurement will provide **first-hand information about t -channel production near threshold**

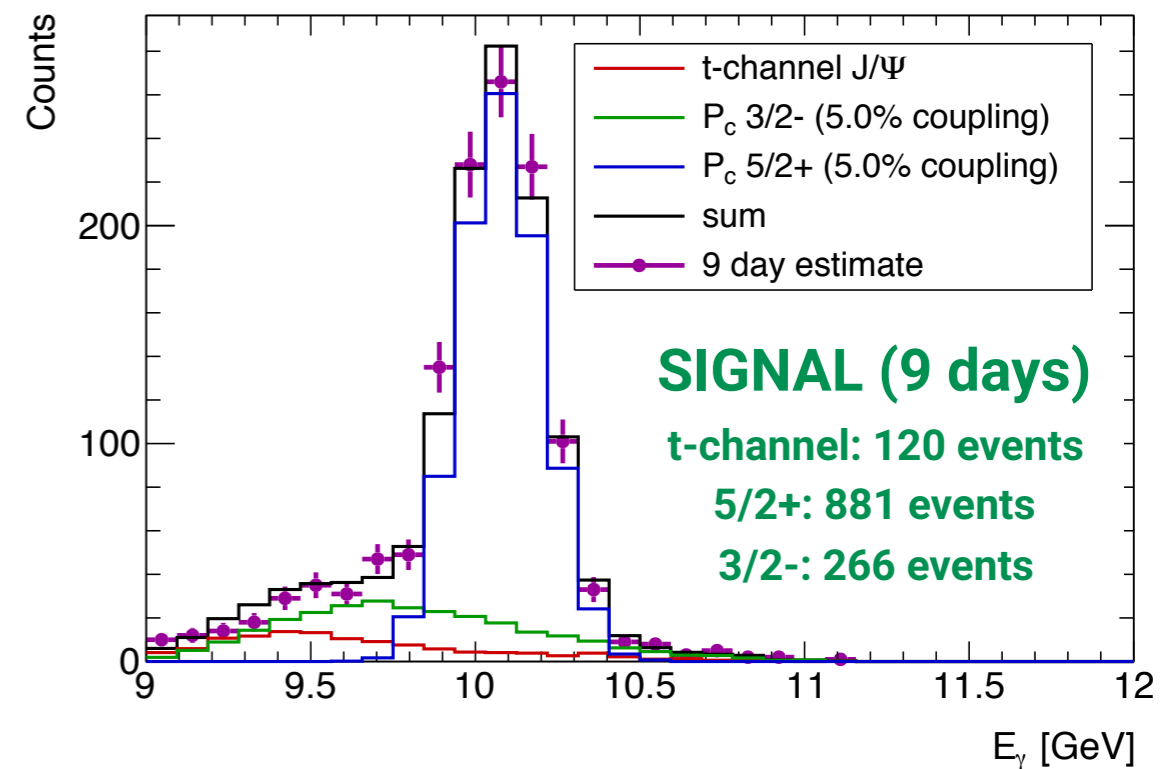
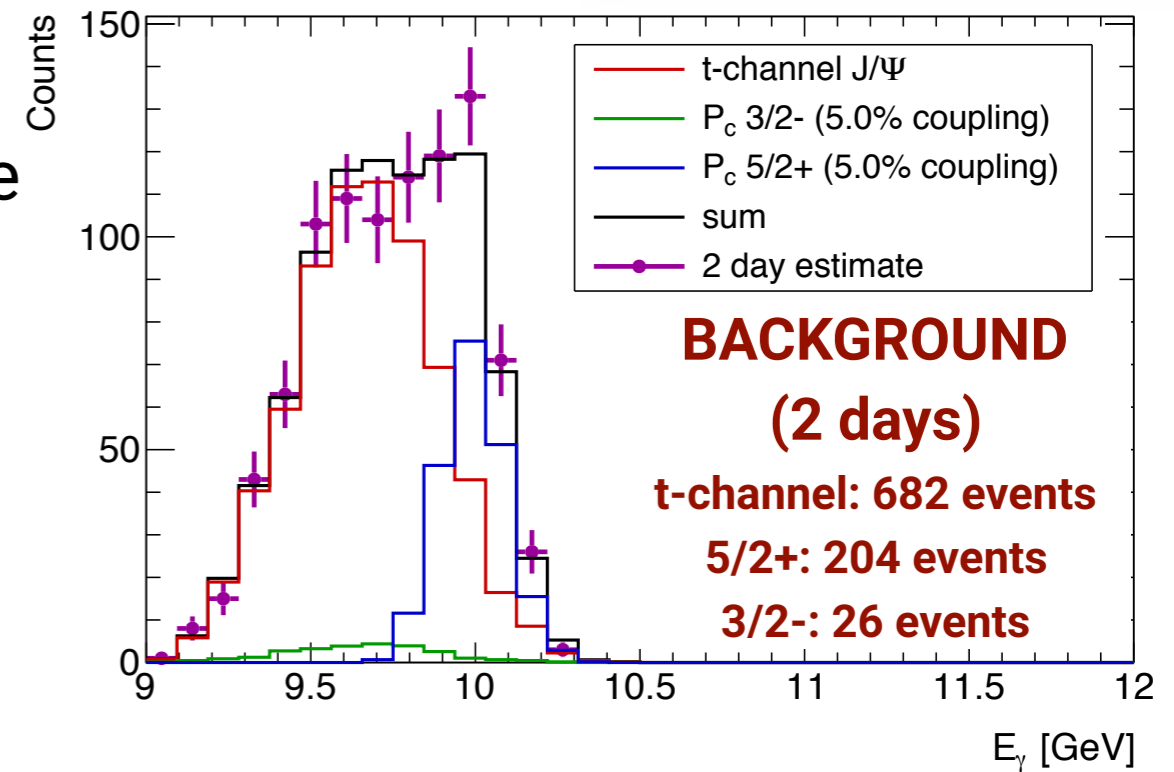

Projected results for P_c search in Hall C

$J/\psi - 007\sigma$

- 2+9 days of beam time at $50\mu\text{A}$
- 5/2+ peak dominates the spectrum**
- ☆ 26x reduction in t -channel background rate
- Background measurement will provide **first-hand information about t -channel production near threshold**

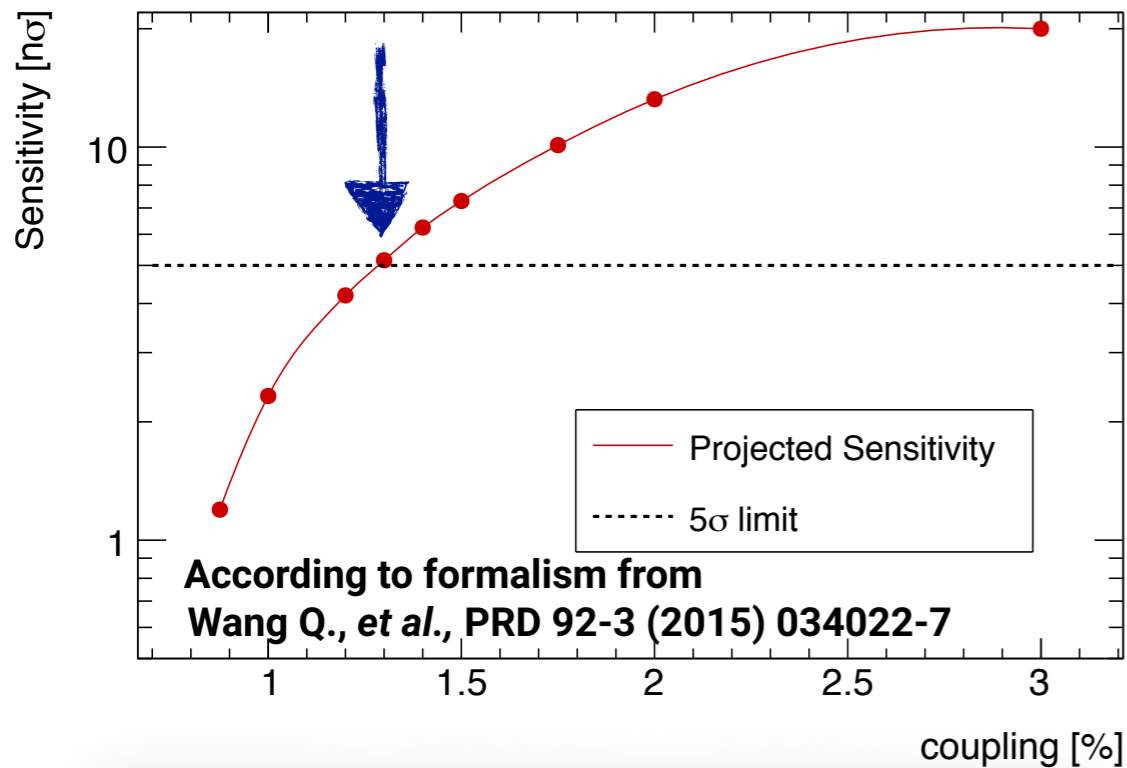

**Significance $> 20\sigma!$
(in case of 5% coupling)**

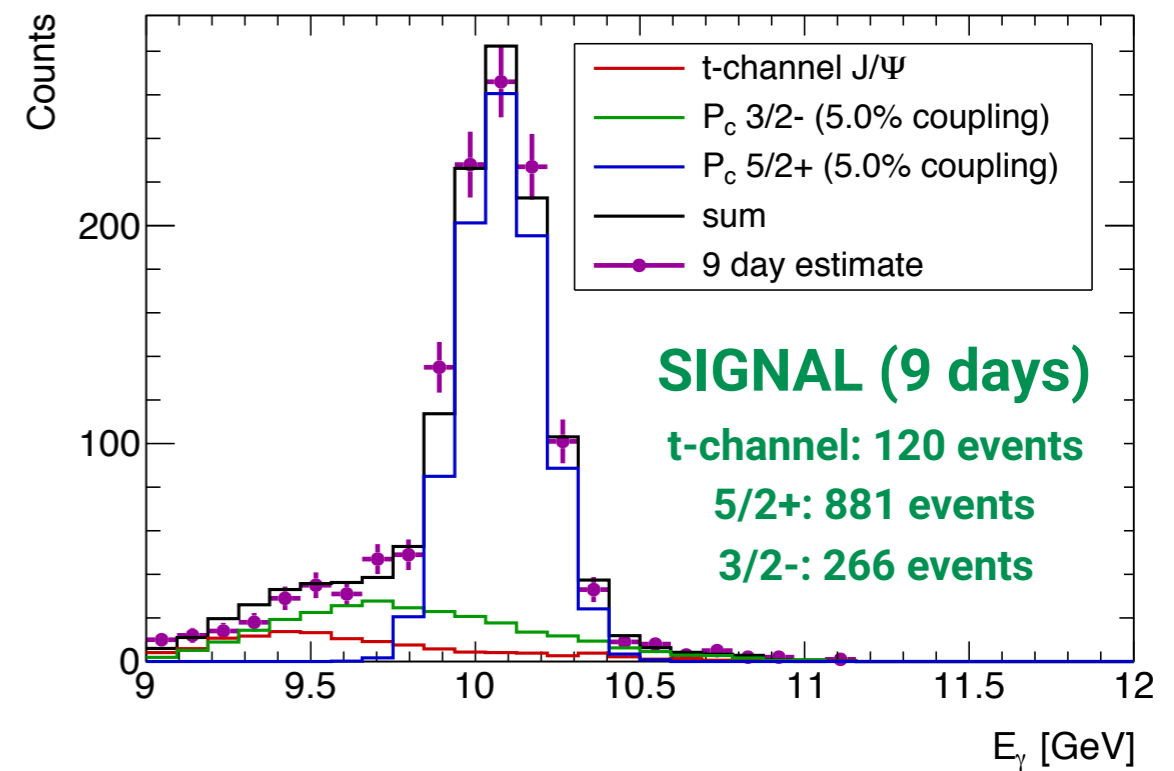
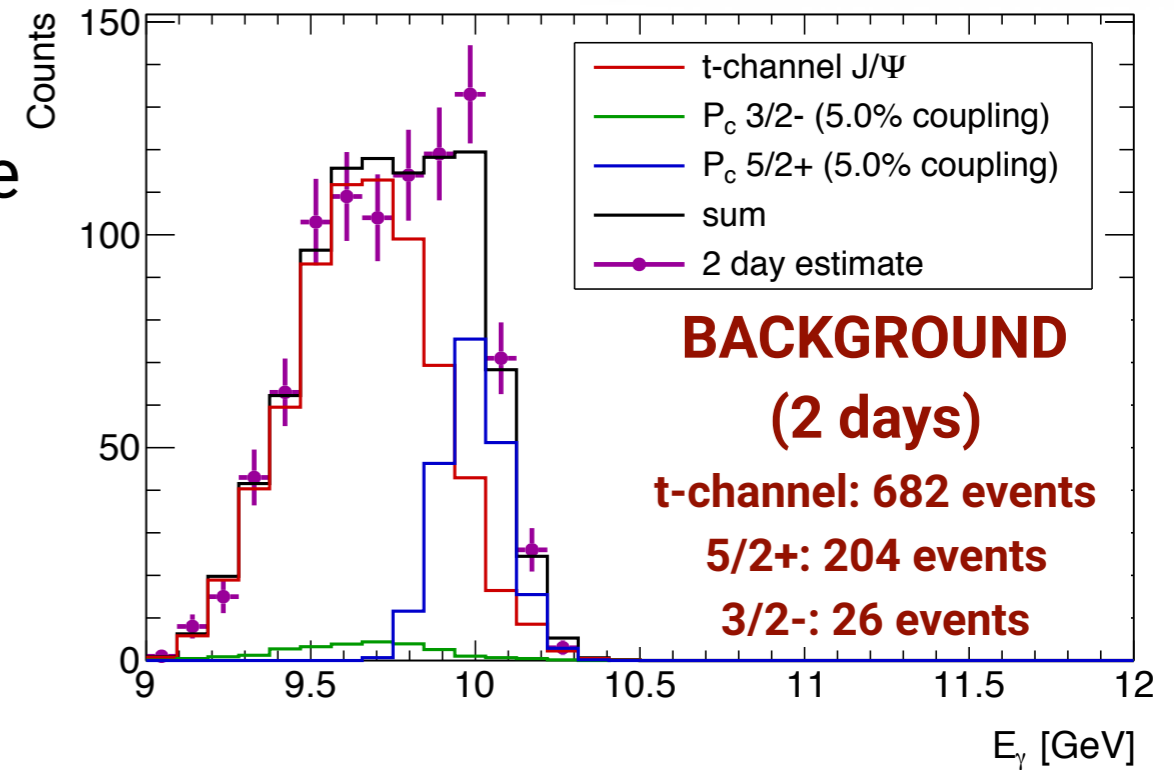

J/ψ experiment E12-12-006 at SoLID

ATHENNA Collaboration

- $3\mu\text{A}$ electron beam at 11 GeV for **50 days**
- 11 GeV beam 15cm **liquid hydrogen target**
- **Ultra-high luminosity** (43.2 ab^{-1})
- General purpose **large-acceptance** spectrometer
- Symmetric acceptance for electrons and positrons

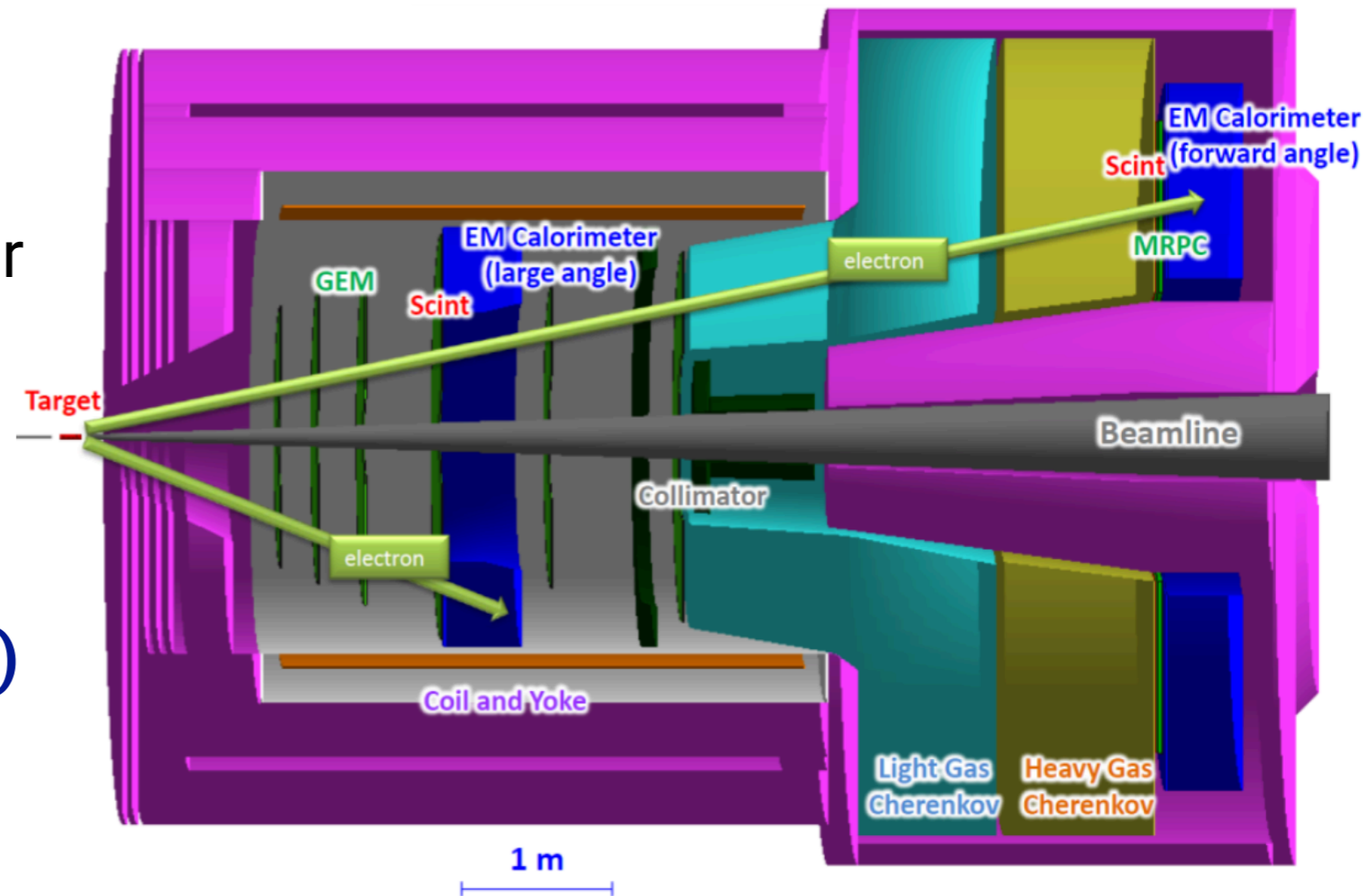

$$\gamma/\gamma^* + N \rightarrow N + J/\psi$$

- Electro-production
- Real photo-production through bremsstrahlung in the target cell

K. Hafidi, S. Joosten et al., *Few Body Syst.* 58 (2017) no.4, 141 and references therein

J/ψ experiment E12-12-006 at SoLID

ATHENNA Collaboration

Photo-production

- 2-fold coincidence + recoil proton
- t -channel J/ψ rate: **1627 per day**
- Advantage over electro-production**
 - Energy reach in charmed pentaquark region
 - High rate

Electro-production

- 3-fold coincidence (3 leptons)
- t -channel J/ψ rate: **86 per day**
- Advantage over photo-production:**
 - Less background
 - Closer to threshold

Sensitivity below 10^{-3} nb !

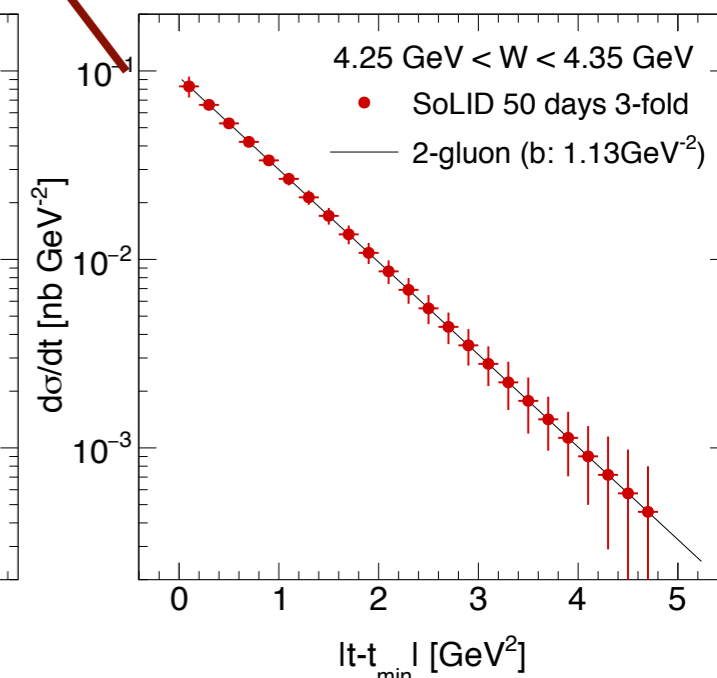
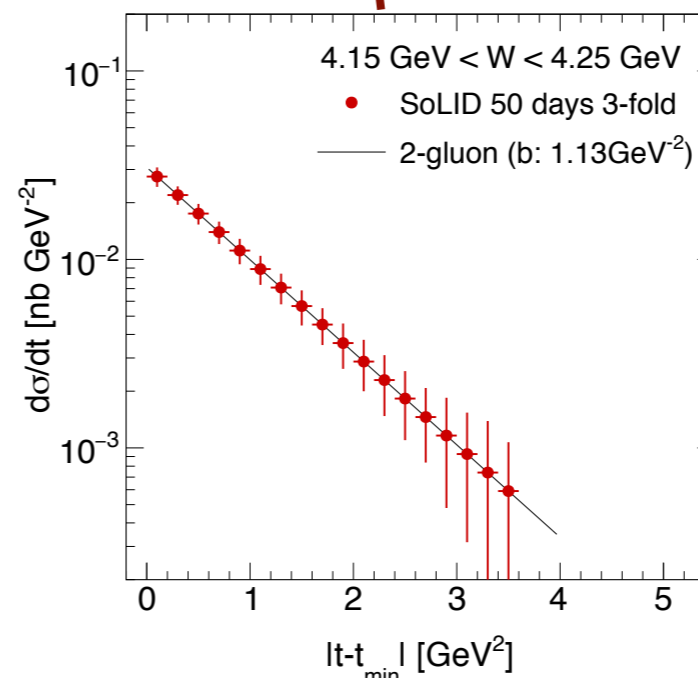
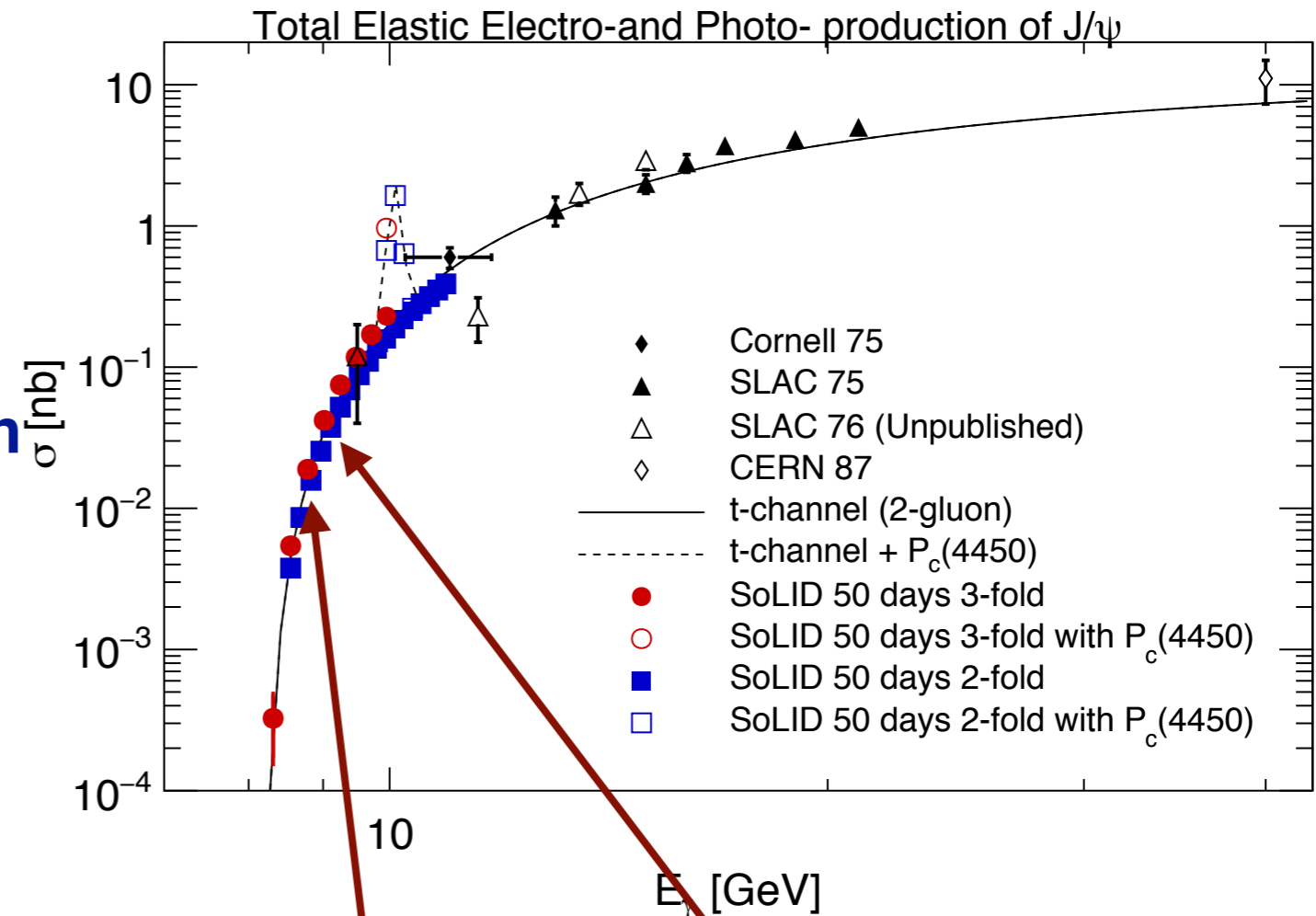

J/ψ experiments at JLab **in a nutshell**

	GlueX HALL D	HMS+SHMS HALL C	CLAS 12 HALL B	SoLID HALL A
J/ψ Rate (photo-prod.)	5-10/day	#1: 13/day #2: 341/day	45/day	1627/day
J/ψ Rate (electro-prod.)				86/day
Experiment		E12-16-007	E12-12-001	E12-12-006
PAC days		9+2	130	50
When?	Ongoing	Early 2019	Ongoing	~10 years?

Exciting times for near-threshold J/ψ production!

Υ photo-production at an EIC

- **Quasi-real production** at an EIC
- Using nominal EIC detector (consistent with white paper)
 - Both electron and muon channel
- **Fully exclusive** reaction
- Can go **to near-threshold region**

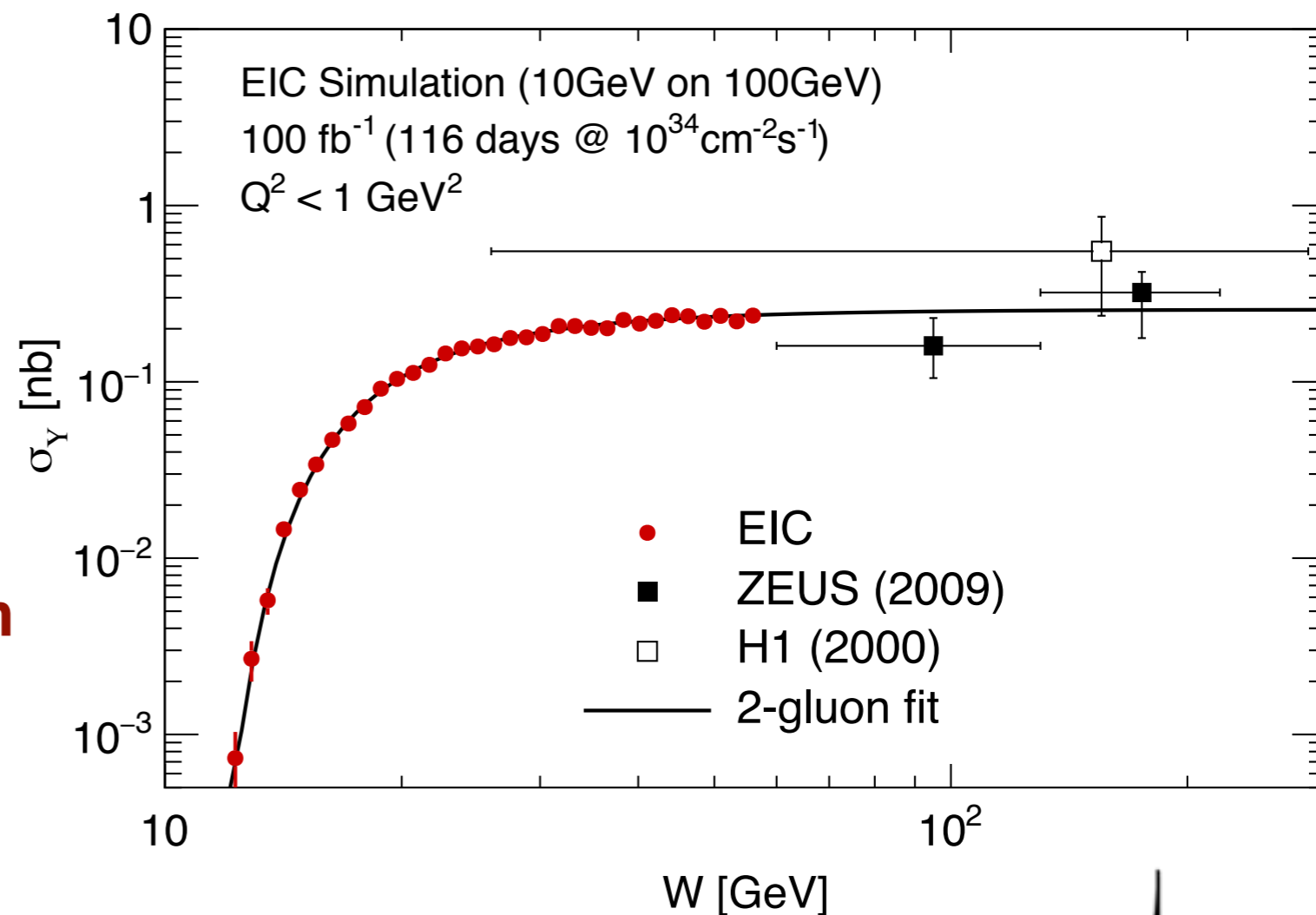

- **$\Upsilon(1s)$ production possible at threshold!**
 - Provides measure for **universality**, complimentary to threshold J/ψ program at JLab12
 - Is there a “beautiful” pentaquark?
- **Sensitivity down to $\sim 10^{-3}$ nb!**

quarkonium production **at high energies**

Deeply-virtual quarkonium production and the gluon GPD

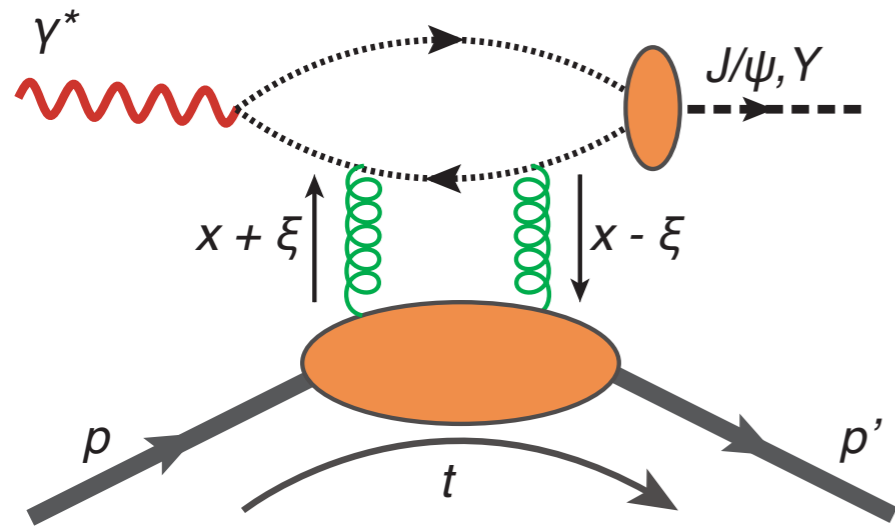

Hard scale: $Q^2 + M_V^2$

Modified Bjorken-x: $x_V = \frac{Q^2 + M_V^2}{2p \cdot q}$

- ☆ **average unpolarized gluon GPD** related to t -dependent cross section (LO)

$$|\langle \mathcal{H}_g \rangle|(t) \propto \sqrt{\frac{d\sigma}{dt}(t) / \frac{d\sigma}{dt}(t=0)}$$

- ☆ **Fourier transform:**
transverse gluonic profile

$$\rho(|\vec{b}_T|, x_V) = \int \frac{d^2 \vec{\Delta}_T}{(2\pi)^2} e^{i\vec{\Delta}_T \vec{b}_T} |\langle \mathcal{H}_g \rangle|(t = -\vec{\Delta}_T^2)$$

Deeply-virtual quarkonium production and the gluon GPD

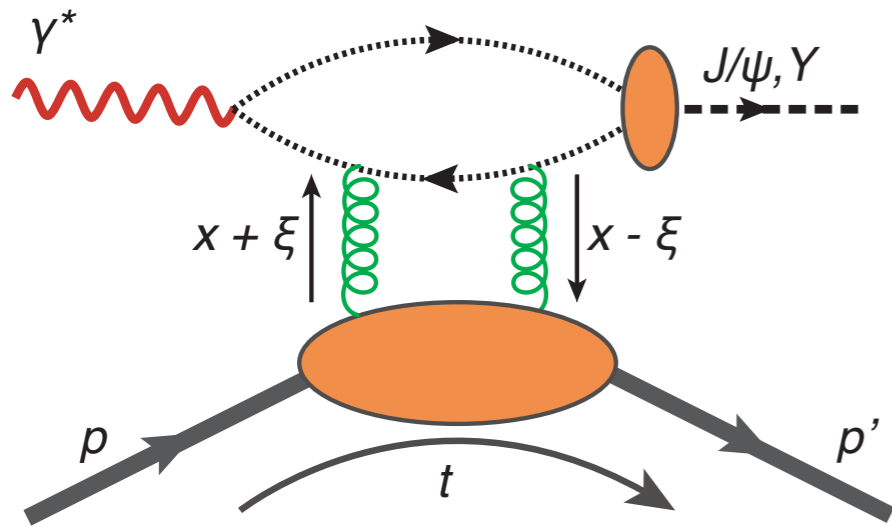

Hard scale: $Q^2 + M_V^2$

Modified Bjorken-x: $x_V = \frac{Q^2 + M_V^2}{2p \cdot q}$

- ★ **average unpolarized gluon GPD** related to t -dependent cross section (LO)

$$|\langle \mathcal{H}_g \rangle|(t) \propto \sqrt{\frac{d\sigma}{dt}(t) / \frac{d\sigma}{dt}(t=0)}$$

- ★ **Fourier transform:**
transverse gluonic profile

$$\rho(|\vec{b}_T|, x_V) = \int \frac{d^2 \vec{\Delta}_T}{(2\pi)^2} e^{i\vec{\Delta}_T \vec{b}_T} |\langle \mathcal{H}_g \rangle|(t = -\vec{\Delta}_T^2)$$

★ Remarks:

- ★ **Simplest possible GPD extraction**
- ★ **Intrinsic systematic uncertainty** due to **extrapolation** outside of measured t -range
- ★ **NLO effects** could be significant
 - ★ Corrections expected to be smaller for $Y(1s)$ than for J/ψ

Gluon tomography with J/ψ

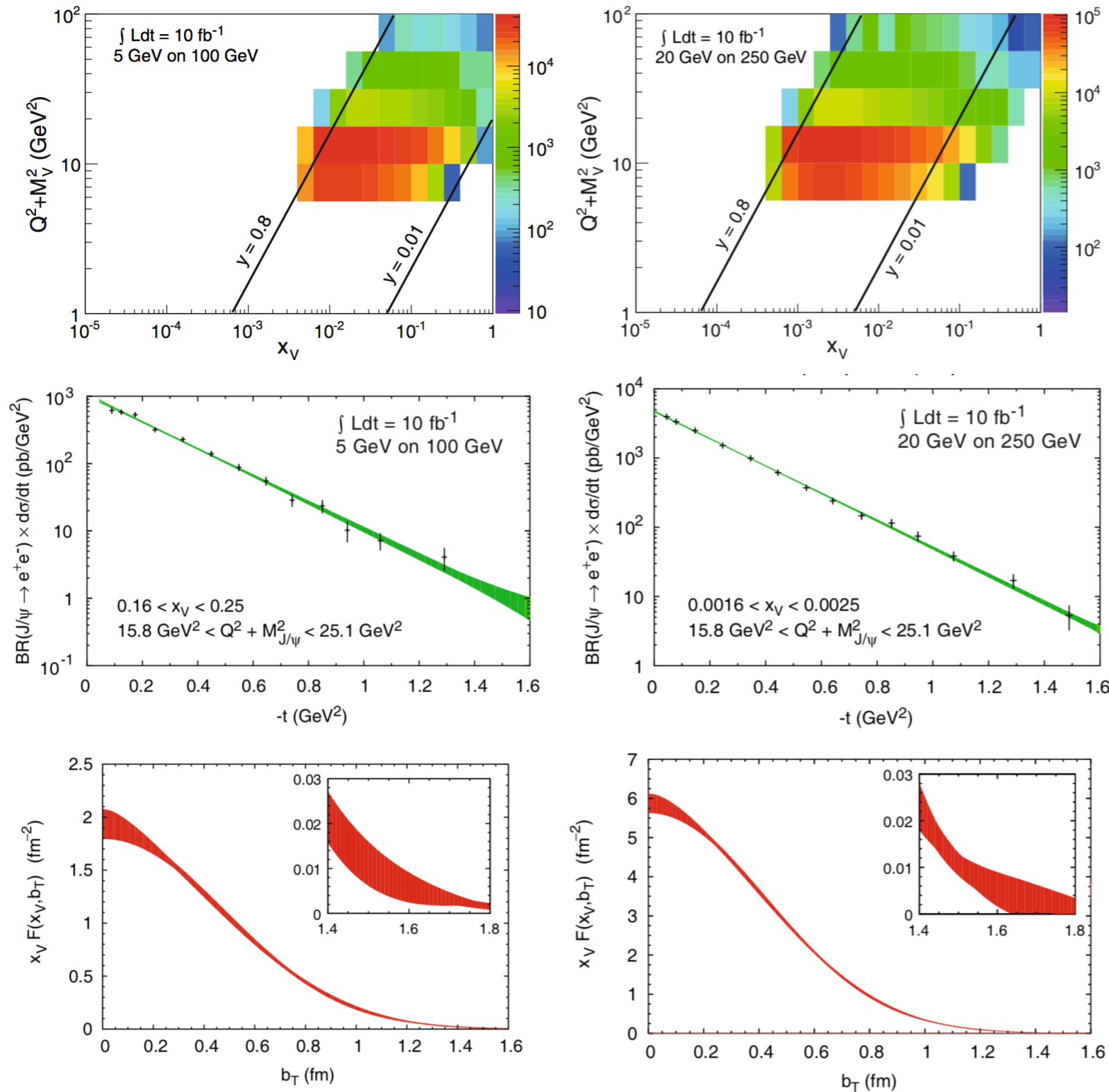

Gluon GPD in fine bins of x_V and Q^2 (from EIC white paper)

t -spectra

Normalized average gluon density

Gluon tomography with J/ψ

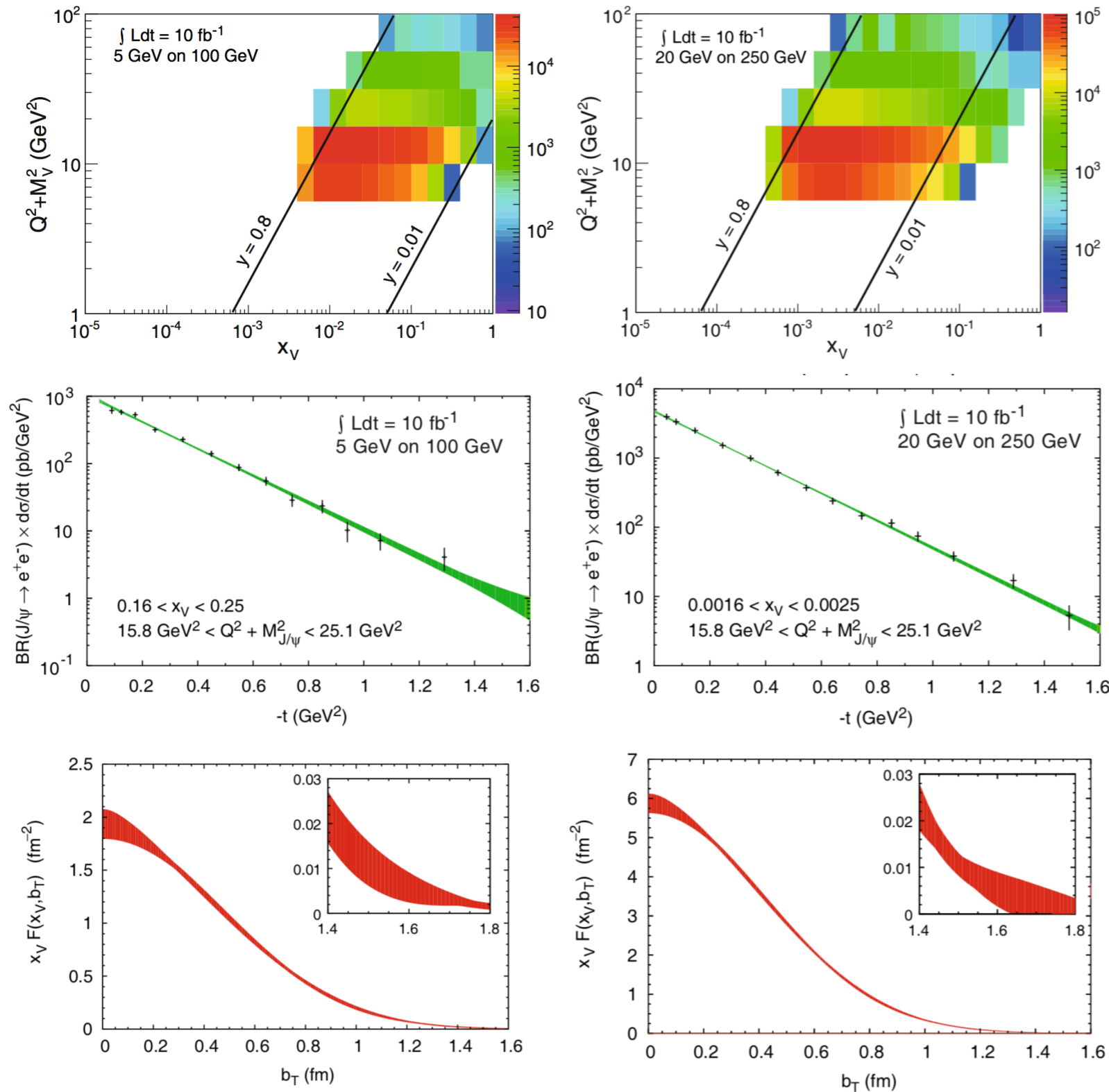

Gluon GPD in fine bins of x_V and Q^2 (from EIC white paper)

t -spectra

**Only possible at an EIC:
from the valence region
deep into the sea!**

**Normalized
average gluon
density**

Gluon tomography with $Y(1s)$

- ★ Nominal EIC detector
- ★ 10x more luminosity
- ★ Electron and muon channels

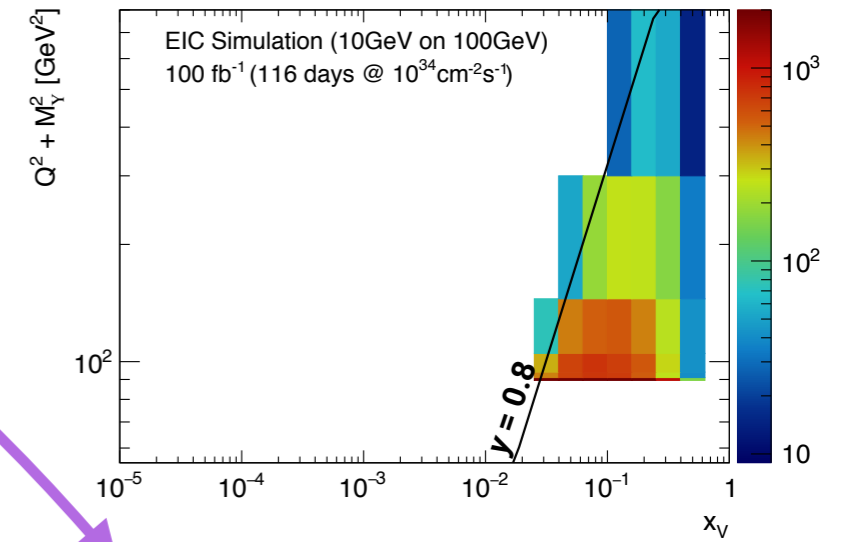
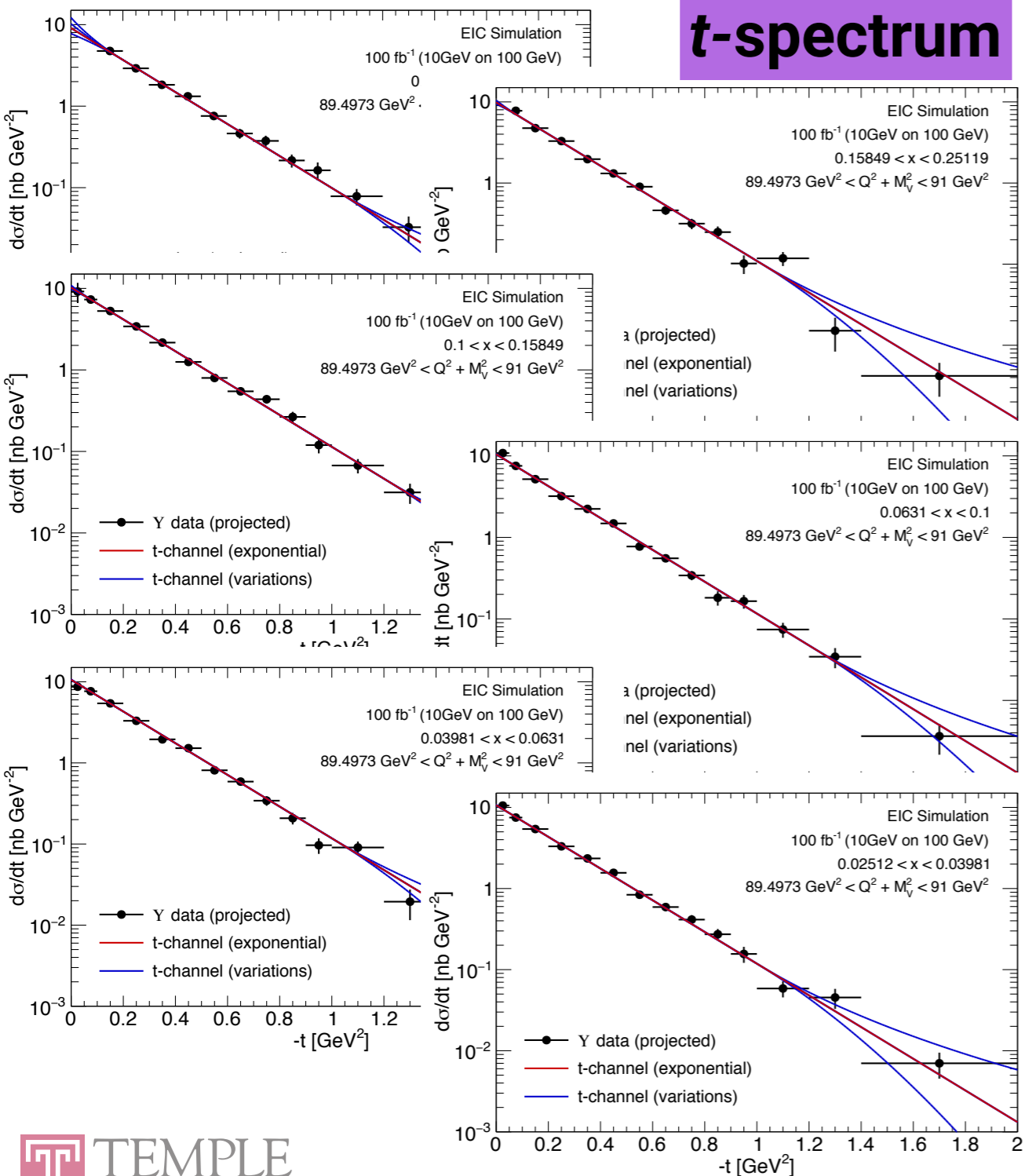

Average gluon density:

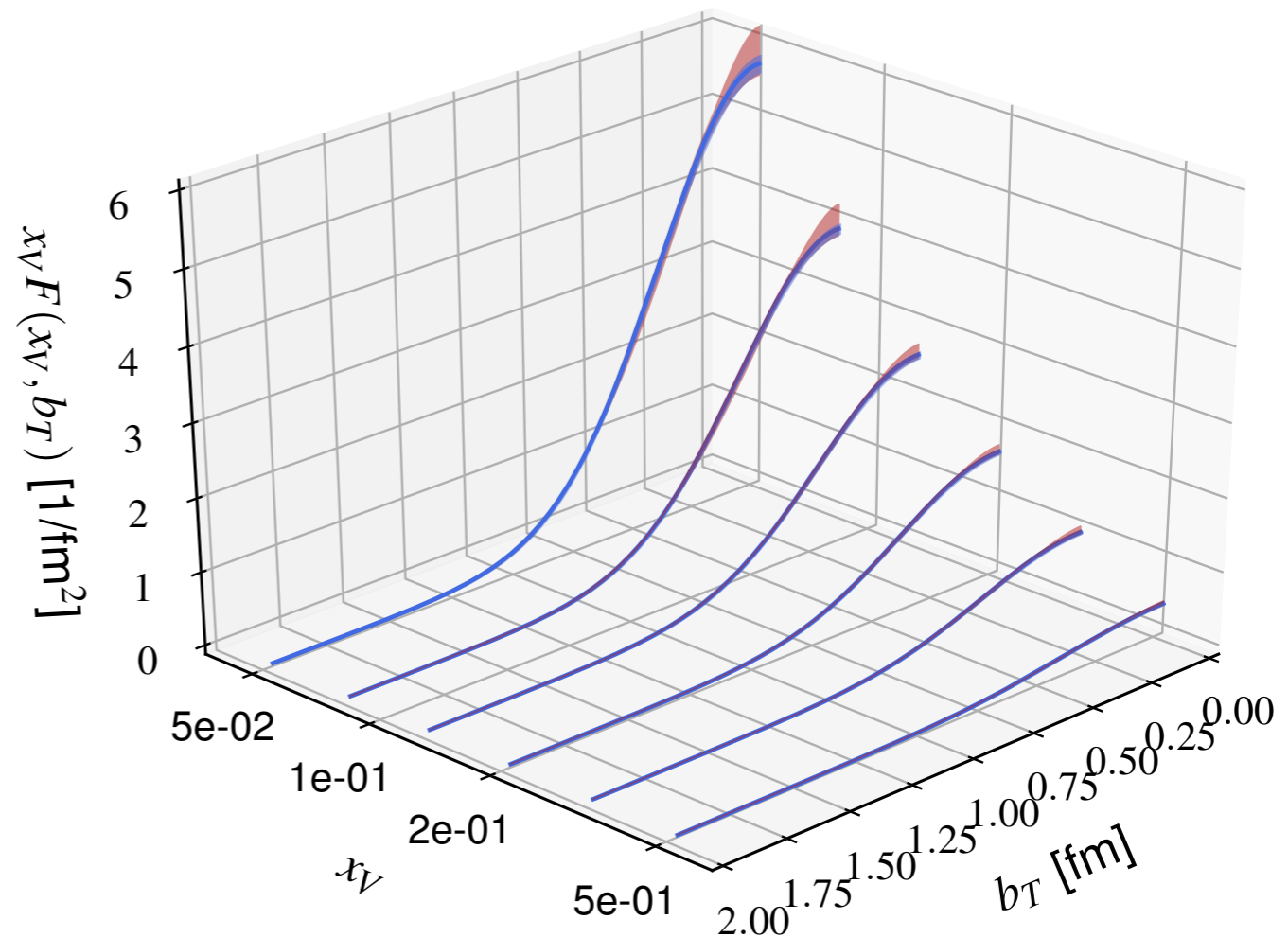

Conclusion

- **Quarkonium** production an important tool to study the **gluonic fields** in the nucleon
- **Threshold production** of quarkonium can shed light on the **trace anomaly**, quarkonium-nucleon **binding** and **proton mass**
- Possible to study “charming” (and “beautiful”?) pentaquarks
- At **high energies**: possible to access **gluon GPDs**
- Can test universality by comparing Y to J/ψ results
- **JLab12 and the EIC** are (will be) perfectly positioned to **significantly contribute to these topics**

This work is supported by DOE grant DE-FG02-94ER4084

BACKUP SLIDES

Accelerator and detector parameters

eRHIC (BNL)

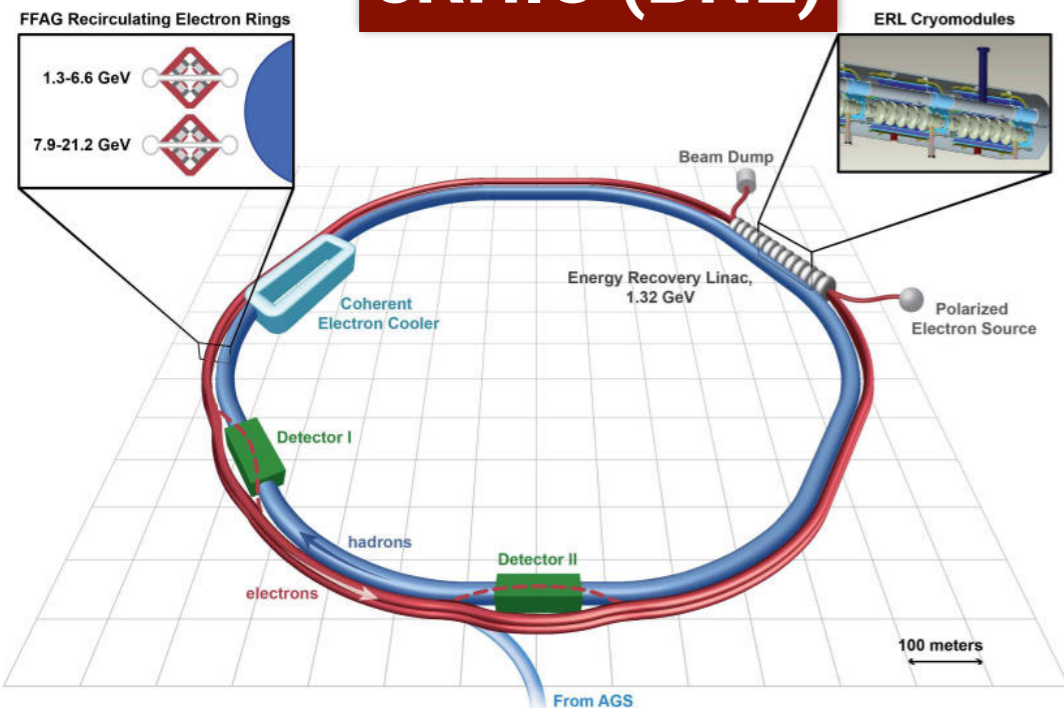

JLEIC (JLab)

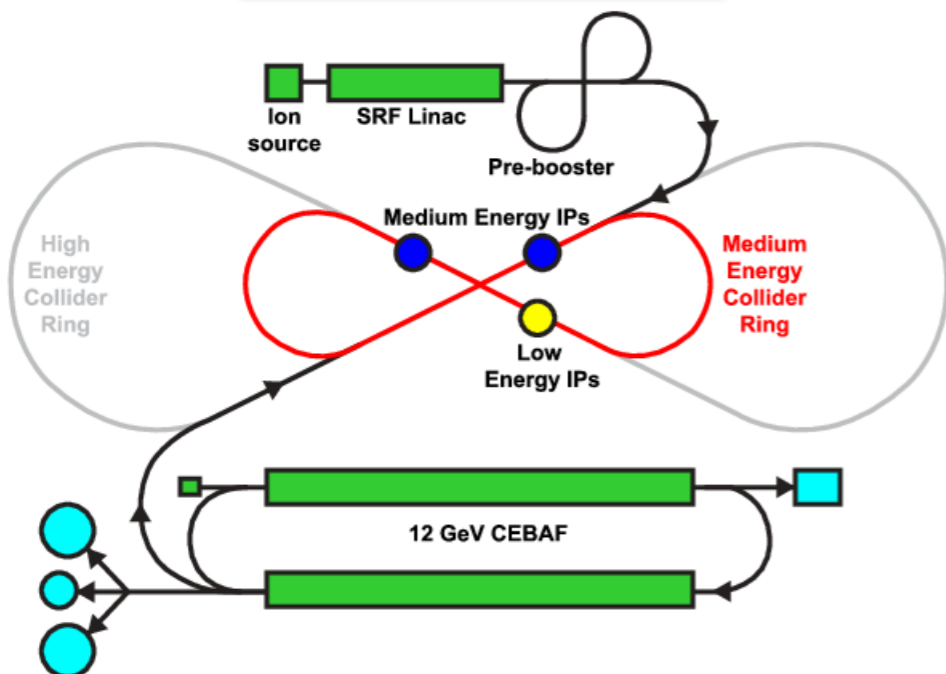

- Nominal parameters relevant to quarkonium production:
 - (Consistent with accelerator/detector specs from white-paper for J/ψ production)
 - **10 GeV electrons on 100 GeV protons:** in range of both designs
 - **Luminosity: 100 fb^{-1}** (116 days @ $10^{34} \text{ cm}^{-2}\text{s}^{-1}$)
 - **Acceptance:**
 - **Leptons:** pseudo-rapidity $|\eta| < 5$
 - **Recoil proton:** scattering angle $\theta > 2 \text{ mrad}$
 - Resolution:
 - Angular $< 0.5 \text{ mrad}$
 - Momentum $< 1\%$

$$\frac{d\sigma}{dQ^2 dy dt} = \Gamma_T (1 + \epsilon R) D \frac{d\sigma_\gamma}{dt}$$

$$R = \left(\frac{AM_V^2 + Q^2}{AM_V^2} \right)^{n_1} - 1$$

$$D = \left(\frac{M_V^2}{M_V^2 + Q^2} \right)^{n_2}$$

$$\frac{d\sigma_\gamma}{dt}$$

- Martynov, et. al., "Photoproduction of Vector Mesons in the Soft Dipole Pomeron Model." PRD 67 (7), 2003. doi:10.1103/PhysRevD.67.074023
- R. Fiore et al., "Exclusive Jpsi electroproduction in a dual model." PRD80:116001, 2009"
- A. Airapetian et al, "Exclusive Leptoproduction of rho0 Mesons on Hydrogen at Intermediate W Values", EPJ C 17 (2000) 389-398
- Adams et al., "Diffractive production of rho0 mesons in muon-proton interactions 470 GeV", ZPC74 (1997) 237-261.
- M Tytgat, "Diffractive production of rho0 and omega vector mesons at HERMES" DESY-Thesis 2001-018 (2001)
- P. Liebing, "Can the Gluon Polarization be Extracted From HERMES Data", DESY-Thesis (2004)
- Brodsky, S J, E Chudakov, P Hoyer, and J M Laget. 2001. "Photoproduction of Charm Near Threshold." Physics Letters B 498 (1-2): 23-28. doi:10.1016/S0370-2693(00)01373-3.

Angular dependence of the decay lepton pair in the J/psi Helicity frame

$$\mathcal{W}(\cos \theta_{\text{CM}}) = \frac{3}{8} (1 + r_{00}^{04} + (1 - 3r_{00}^{04}) \cos^2 \theta_{\text{CM}})$$

$$R = \frac{1}{\epsilon} \frac{r_{00}^{04}}{1 - r_{00}^{04}}$$

- J. Breitweg et al. (ZEUS), Exclusive electro-production of rho0 and J/psi mesons at HERA, EPJ-C 6-4 (1999)
- Chekanov et al. (ZEUS), Exclusive photo production of J/psi mesons at HERA (2002)
- K. Schilling et. Al, Nucl.Phys. B 61, 381 (1973)

Photon Energy Reconstruction

- Can **unambiguously** reconstruct the initial photon energy from the reconstructed J/ψ momentum and energy
- Assumptions:
 - photon beam along the z-axis
 - proton target at rest
 - 2 final state particles: a proton and a J/ψ

$$E_\gamma = \frac{M_J^2 - 2E_J M_P}{2(E_J - M_p - P_J \cos \theta)}$$

L-T separation and the Q^2 dependence of R

- **s-channel helicity conservation (SCHC):**
 - J/ψ takes on (virtual) photon polarization
 - **Angular distribution of the decay pair**

$$\mathcal{W}(\cos \theta_{\text{CM}}) = \frac{3}{8} (1 + r_{00}^{04} + (1 - 3r_{00}^{04}) \cos^2 \theta_{\text{CM}})$$

- Can extract **R in 3D** (Q^2, x_V, t)

$$R \equiv \frac{\sigma_L}{\sigma_T} = \frac{1}{\epsilon} \frac{r_{00}^{04}}{1 - r_{00}^{04}}$$

