

European
Research
Council

Flavour Physics circa 2013

Tim Gershon
University of Warwick and CERN

2 May 2013



Outline

- Why flavour physics in the LHC era?
- Selected highlights of recent results
 - Production and spectroscopy
 - CP violation and the Unitarity Triangle
 - Rare decays
- Future prospects

Quark flavour mixing a.k.a. CKM phenomenology

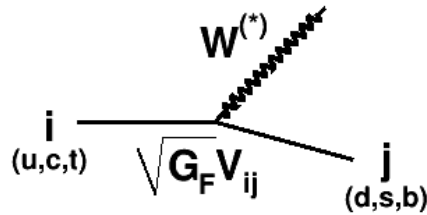

$$V_{CKM} = \begin{pmatrix} V_{ud} & V_{us} & V_{ub} \\ V_{cd} & V_{cs} & V_{cb} \\ V_{td} & V_{ts} & V_{tb} \end{pmatrix} = \begin{pmatrix} 1 - \frac{1}{2}\lambda^2 & \lambda & A\lambda^3(\rho - i\eta) \\ -\lambda & 1 - \frac{1}{2}\lambda^2 & A\lambda^2 \\ A\lambda^3(1 - \rho - i\eta) & -A\lambda^2 & 1 \end{pmatrix} + O(\lambda^4)$$

N.B. V_{ts} has imaginary part at $O(\lambda^4)$

- CKM theory is highly predictive
 - huge range of phenomena over a massive energy scale predicted by only 4 independent parameters
- CKM matrix is hierarchical
 - theorised connections to quark mass hierarchies, or (dis-)similar patterns in the lepton sector
 - origin of CKM matrix from diagonalisation of Yukawa (mass) matrices after electroweak symmetry breaking
 - distinctive flavour sector of Standard Model not necessarily replicated in extended theories → strong constraints on models
- CKM mechanism introduces CP violation
 - only source of CP violation in the Standard Model ($m_\nu = \theta_{QCD} = 0$)

Two routes to heaven for flavour physics

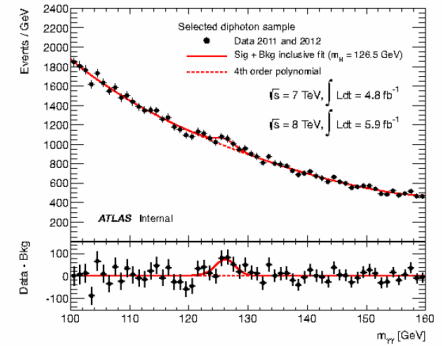

CP violation
(extra sources must exist)

But

- No guarantee of the scale
- No guarantee of effects in the quark sector
- Realistic prospects for CPV measurement in νs due to large θ_{13}

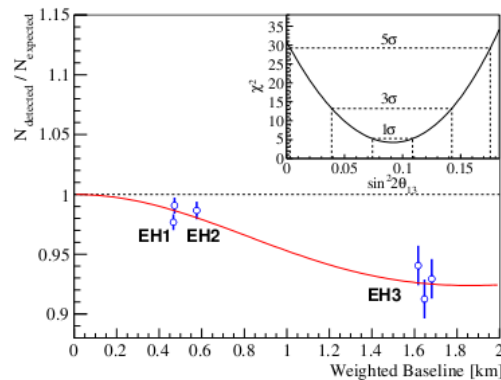

SM

Rare decays
(strong theoretical arguments)

But

- How high is the NP scale?
- Why have FCNC effects not been seen?

NP

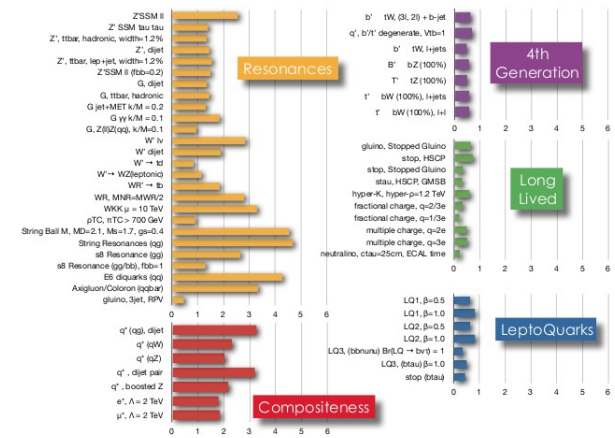

Absence of NP signals at ATLAS/CMS → argument for searches via rare decays stronger

Search for $\mu^+ \rightarrow e^+ \gamma$

$\mu^+ \rightarrow e^+ \gamma$

- positive muons \rightarrow no muonic atoms
- continuous (DC) muon beam at PSI \rightarrow minimise accidental coincidences

MEG arXiv:1303.0754

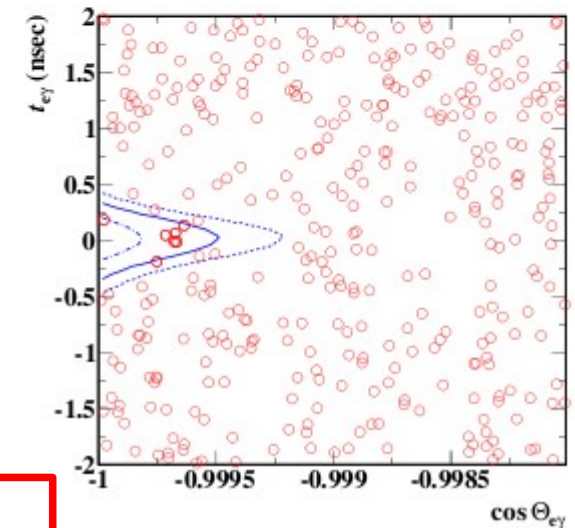
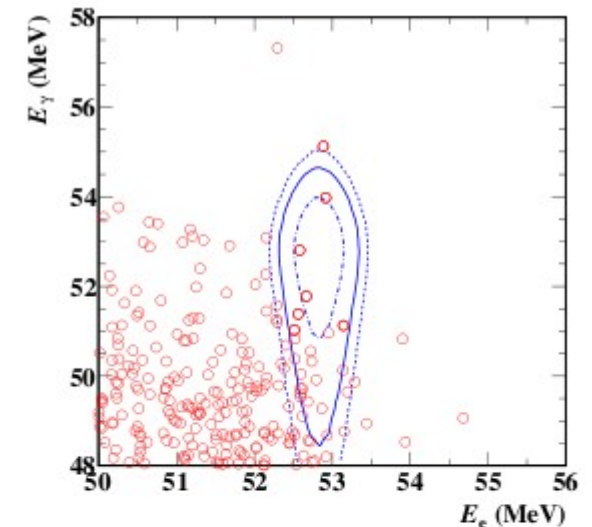
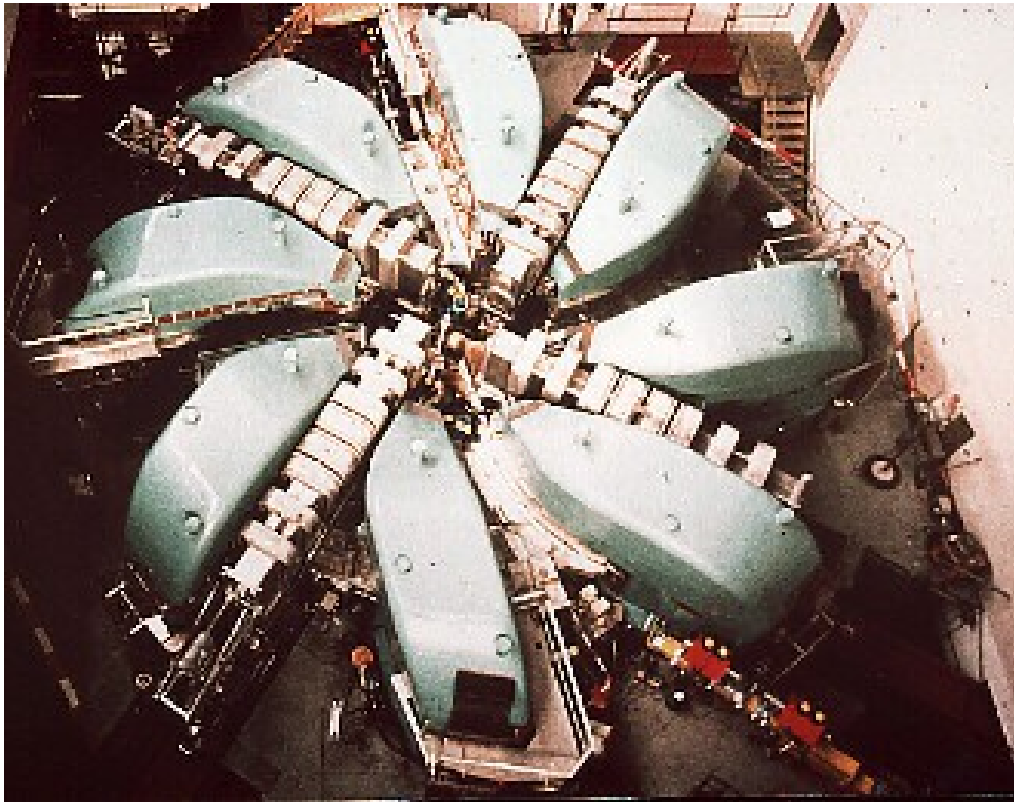

$$B(\mu^+ \rightarrow e^+ \gamma) < 5.7 \cdot 10^{-13} \text{ @ 90\% CL}$$

Why flavour physics in the LHC era?

- There is still much physics to be done with the datasets of BaBar, Belle, CDF, D0, CLEO, BES, etc.
 - Discovery potential complementary to other experiments
 - New experiments in the charged lepton sector add additional potential
- LHC is the world's most copious source of heavy flavoured fermions
 - LHCb experiment instruments the forward region for best b & c physics capability
 - extends the physics reach of the LHC programme, exploring *beyond* the energy frontier
 - Must also exploit the capability of ATLAS and CMS in this sector
- In addition to studying flavour-changing phenomena, excellent opportunities to study unresolved issues in QCD
 - Puzzles concerning heavy flavour production and spectroscopy

The LHCb detector

- In high energy collisions, $b\bar{b}$ pairs produced predominantly in forward or backward directions
- LHCb is a forward spectrometer
 - a new concept for HEP experiments

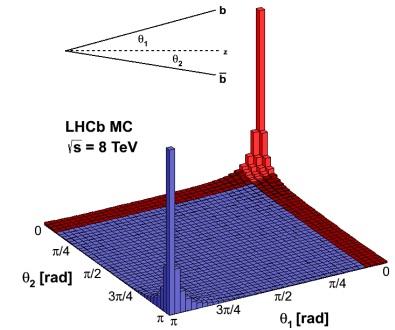

The LHCb Detector
JINST 3 (2008) S08005

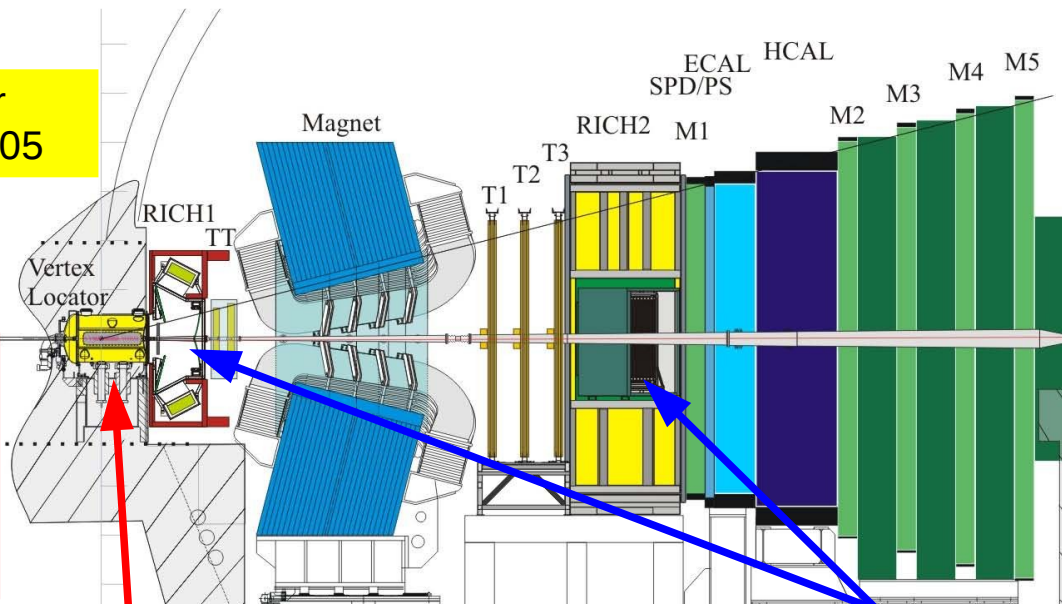

Precision primary and secondary vertex measurements

Excellent K/π separation capability

The LHCb trigger

JINST 8 (2013) P04022

Challenge is

- to efficiently select most interesting B decays
- while maintaining manageable data rates

Main backgrounds

- “minimum bias” inelastic pp scattering
- other charm and beauty decays

Handles

- high p_T signals (muons)
- displaced vertices

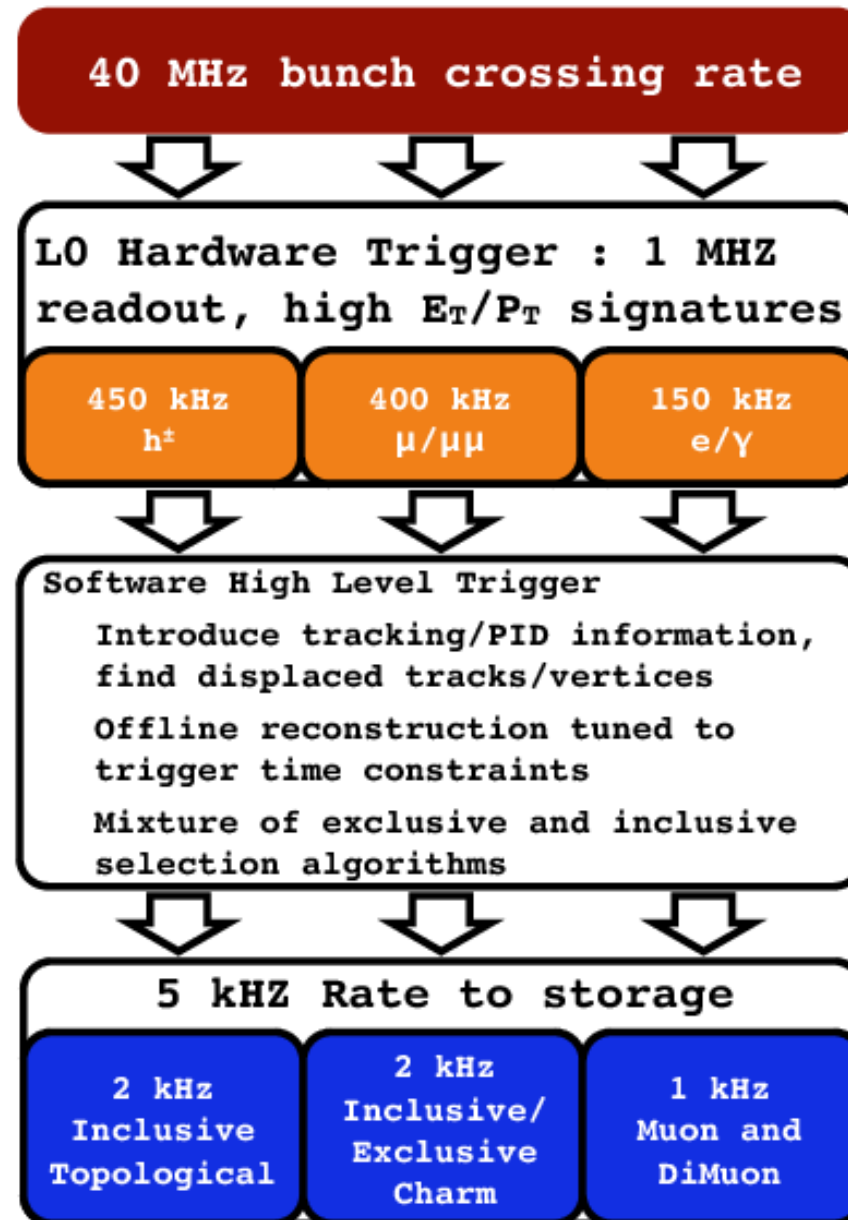

Selected highlights of results Production and spectroscopy

Observations of new states

(no, not the Higgs)

“Observation of a New χ_b State in Radiative Transitions to $Y(1S)$ and $Y(2S)$ at ATLAS”

Phys. Rev. Lett. 108 (2012) 152001

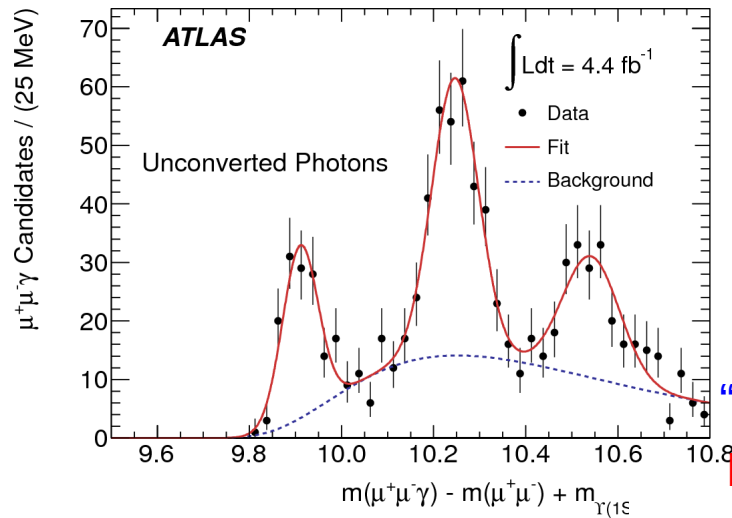

“Observation of excited Λ_b^0 baryons”

Phys. Rev. Lett. 109 (2012) 172003

“Observation of a New Ξ_b Baryon”

Phys. Rev. Lett. 108 (2012) 252002

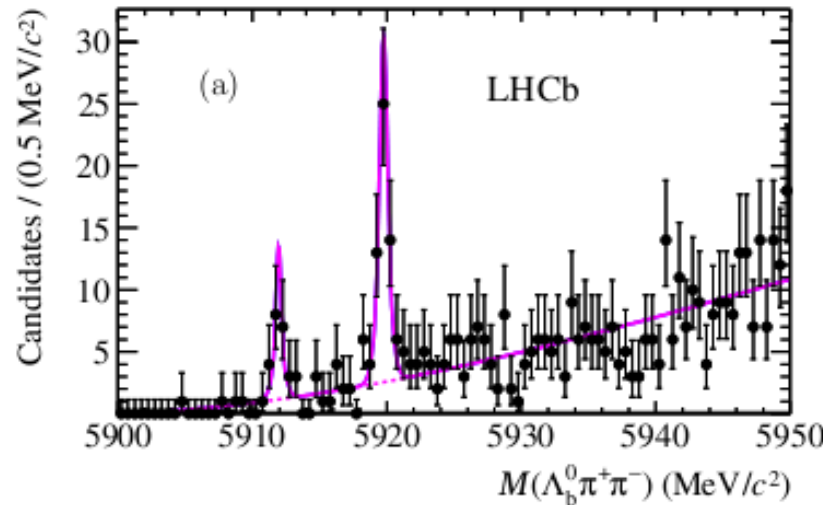
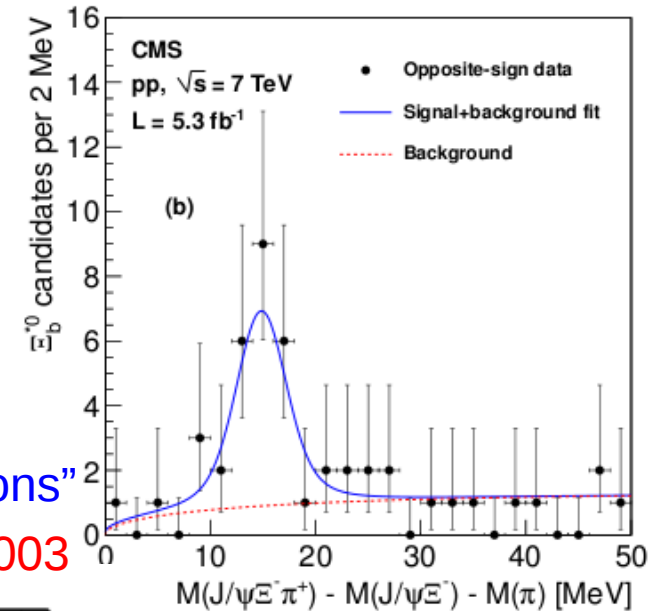

Unconventional states (I)

X(3872)

LHCb arXiv:1302.6269

- X(3872) discovered in $B \rightarrow XK$, with $X \rightarrow J/\psi\pi\pi$ (Belle PRL 91 (2003) 262001)
- **Does not fit well with expectations for conventional states**
 - above open charm threshold but narrow
- J^{PC} limited to 1^{++} or 2^{-+} by previous analyses (CDF PRL 98 (2007) 132002)
- LHCb analysis uses production from B decay, and full (5D) angular distribution of decay chain (assuming $J^{PC}(\pi\pi) = 1^{-}$; see also CMS arXiv:1302.3968)
- Likelihood ratio test used to compare hypotheses

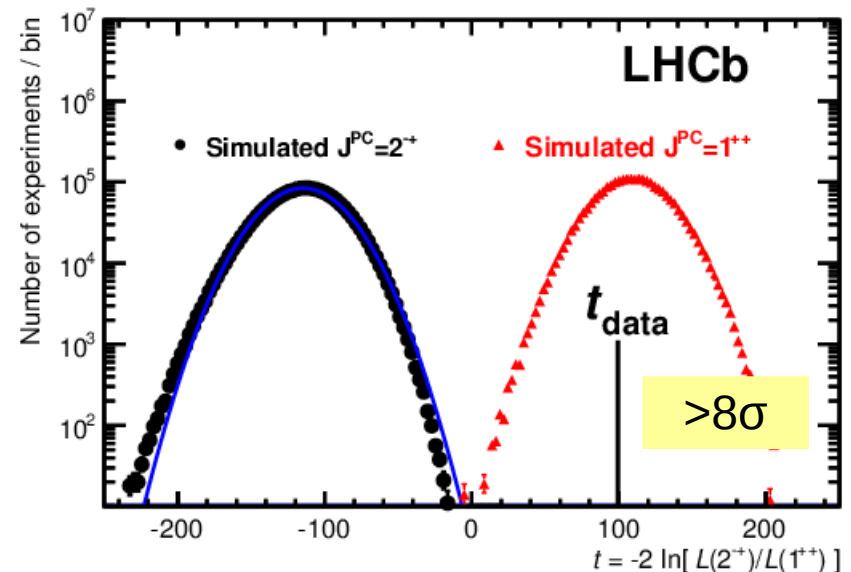
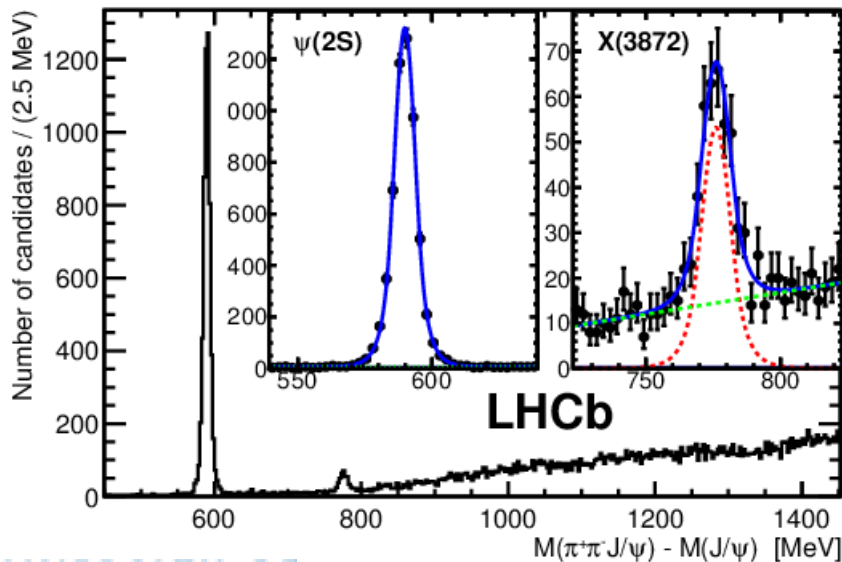

$J^{PC} = 1^{++}$ supports molecular interpretation of X(3872)
... but then how to explain production in hadron collisions?

Unconventional states (II)

Charged bottomonium-like states

Belle

PRL 108 (2012) 122001

Studied in " $\Upsilon(5S)$ " \rightarrow $(b\bar{b})\pi^+\pi^-$
amplitude analyses

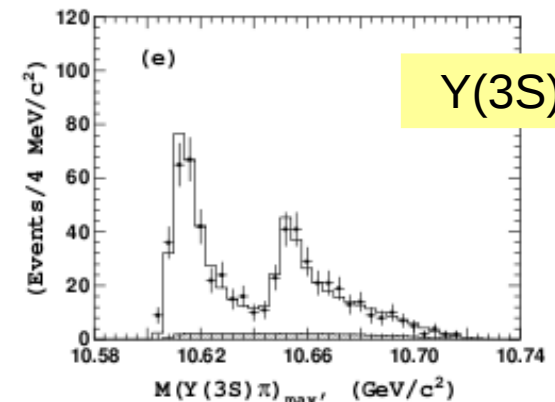
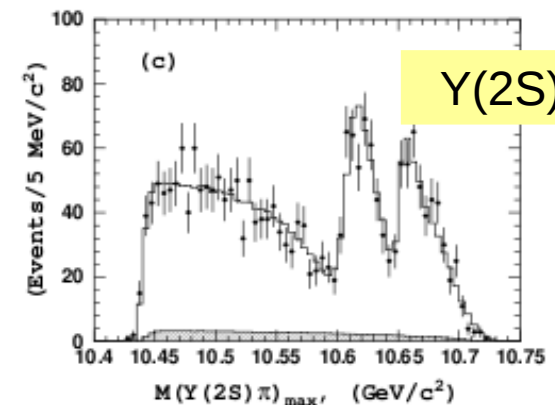
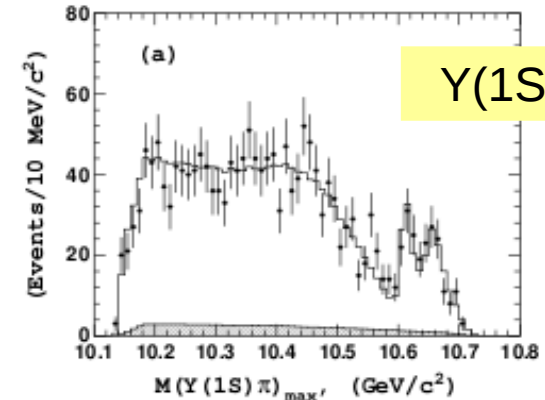
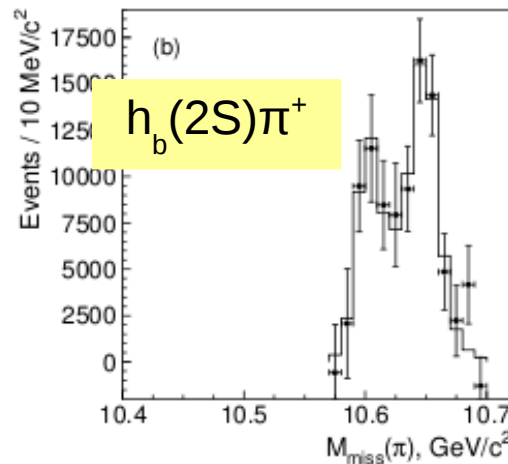
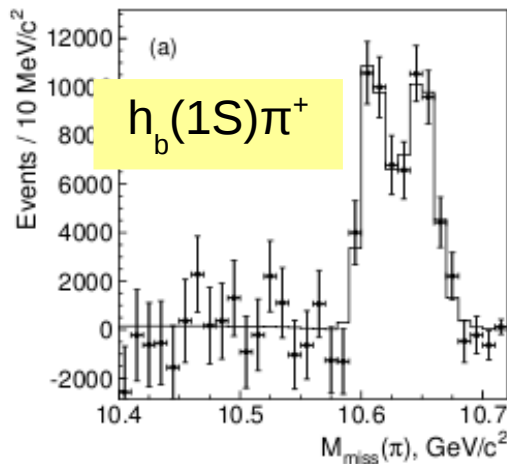

Final state	$\Upsilon(1S)\pi^+\pi^-$	$\Upsilon(2S)\pi^+\pi^-$	$\Upsilon(3S)\pi^+\pi^-$	$h_b(1P)\pi^+\pi^-$	$h_b(2P)\pi^+\pi^-$
$M[Z_b(10610)], \text{MeV}/c^2$	$10611 \pm 4 \pm 3$	$10609 \pm 2 \pm 3$	$10608 \pm 2 \pm 3$	$10605 \pm 2^{+3}_{-1}$	10599^{+6+5}_{-3-4}
$\Gamma[Z_b(10610)], \text{MeV}$	$22.3 \pm 7.7^{+3.0}_{-4.0}$	$24.2 \pm 3.1^{+2.0}_{-3.0}$	$17.6 \pm 3.0 \pm 3.0$	$11.4^{+4.5+2.1}_{-3.9-1.2}$	13^{+10+9}_{-8-7}
$M[Z_b(10650)], \text{MeV}/c^2$	$10657 \pm 6 \pm 3$	$10651 \pm 2 \pm 3$	$10652 \pm 1 \pm 2$	$10654 \pm 3^{+1}_{-2}$	10651^{+2+3}_{-3-2}
$\Gamma[Z_b(10650)], \text{MeV}$	$16.3 \pm 9.8^{+6.0}_{-2.0}$	$13.3 \pm 3.3^{+4.0}_{-3.0}$	$8.4 \pm 2.0 \pm 2.0$	$20.9^{+5.4+2.1}_{-4.7-5.7}$	$19 \pm 7^{+11}_{-7}$
Rel. normalization	$0.57 \pm 0.21^{+0.19}_{-0.04}$	$0.86 \pm 0.11^{+0.04}_{-0.10}$	$0.96 \pm 0.14^{+0.08}_{-0.05}$	$1.39 \pm 0.37^{+0.05}_{-0.15}$	$1.6^{+0.6+0.4}_{-0.4-0.6}$
Rel. phase, degrees	$58 \pm 43^{+4}_{-9}$	$-13 \pm 13^{+17}_{-8}$	$-9 \pm 19^{+11}_{-26}$	187^{+44+3}_{-57-12}	$181^{+65+74}_{-105-109}$

Interpretation of Z_b^+ states as $B^{(*)}B^*$ molecules

Unconventional states (III)

Charged charmonium-like states

BESIII arXiv:1303.5949
also Belle arXiv:1304.0121

Studied in $Y(4260) \rightarrow J/\psi \pi^+ \pi^-$
not amplitude analysis

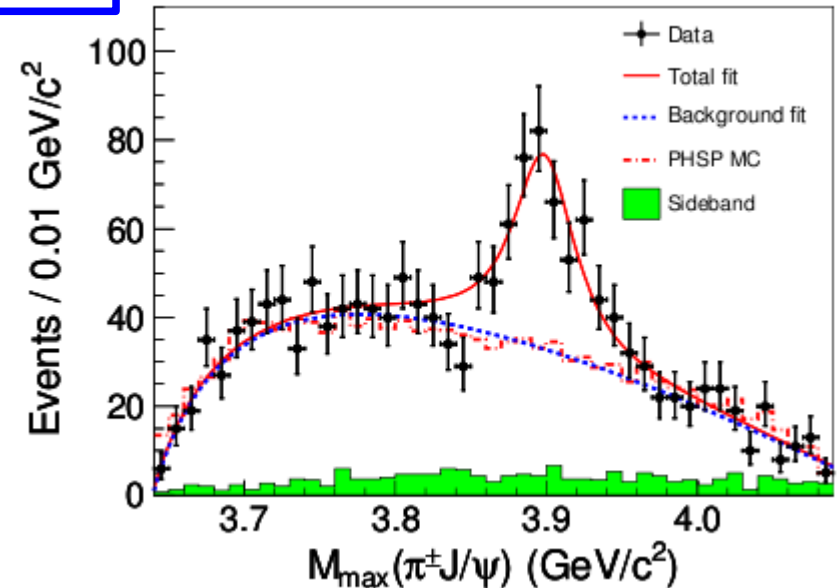
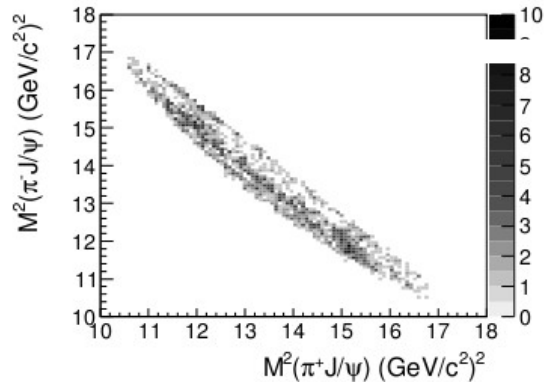
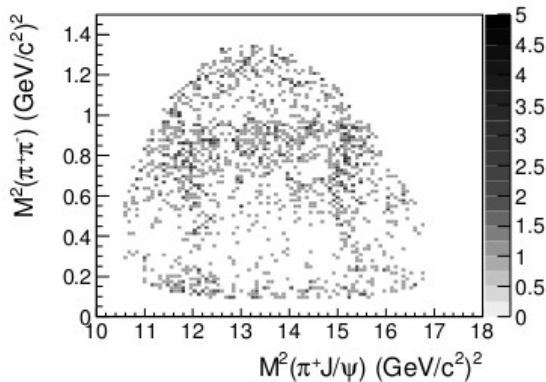

$Z_c(3900)$ adds to a list of claimed charged charmonium-like states

($Z(4430)$ in $\psi'\pi^+$, $Z_1(4050)$, $Z_2(4250)$ in $\chi_{c1}\pi^+$)

Independent confirmations (or refutations) needed ...

Careful amplitude analyses are necessary to understand broad peaks

“The story of the pentaquark shows how poorly we understand QCD” – F. Wilczek, 2005
→ are we approaching understanding beyond $q\bar{q}$ and qqq ?

Selected highlights of results CP violation and the Unitarity Triangle



The Unitarity Triangle

- The CKM matrix must be unitary

$$V_{CKM}^+ V_{CKM} = V_{CKM} V_{CKM}^+ = 1$$

- Provides numerous tests of constraints between independent observables, such as

$$|V_{ud}|^2 + |V_{us}|^2 + |V_{ub}|^2 = 1$$

$$V_{ud} V_{ub}^* + V_{cd} V_{cb}^* + V_{td} V_{tb}^* = 0$$

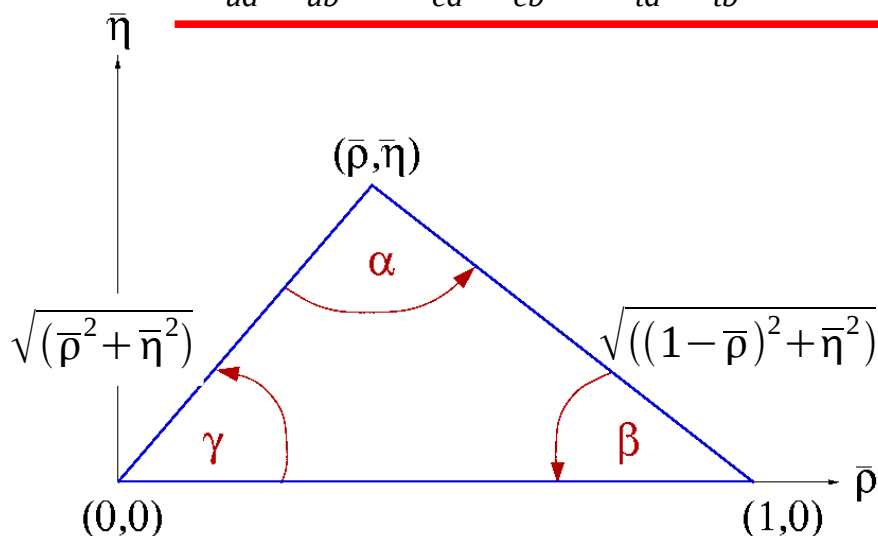

<http://ckmfitter.in2p3.fr>
see also <http://www.utfit.org>

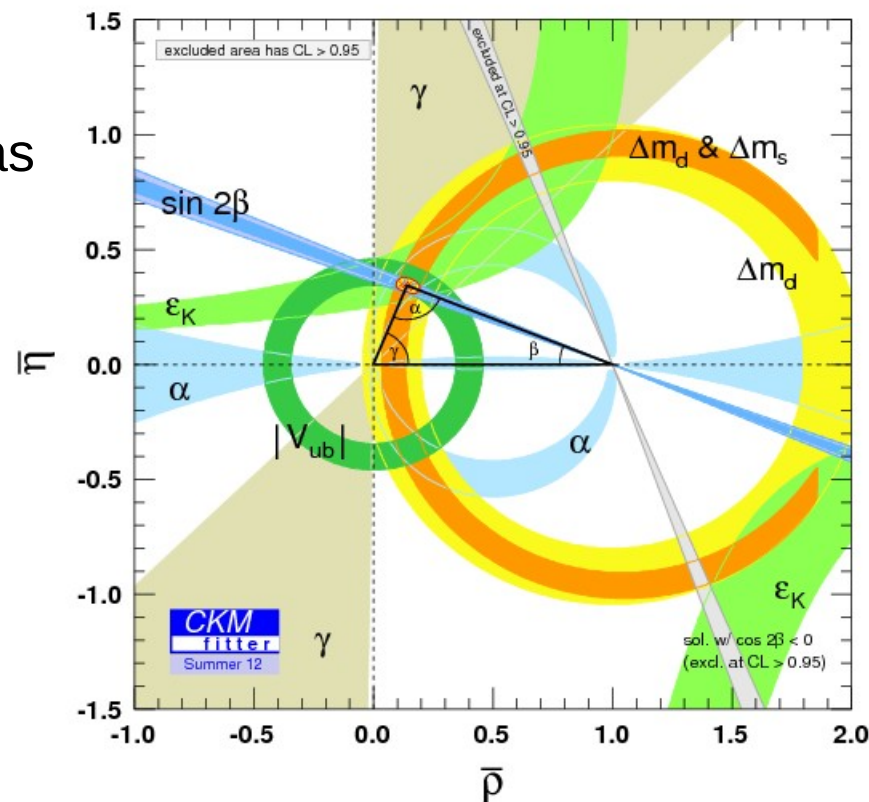

Consistency of measurements tests the Standard Model and provides model-independent constraints on New Physics

Large CP violation effects exist $\sin(2\beta)$ from $B^0 \rightarrow J/\psi K_S^0$

BABAR

BELLE

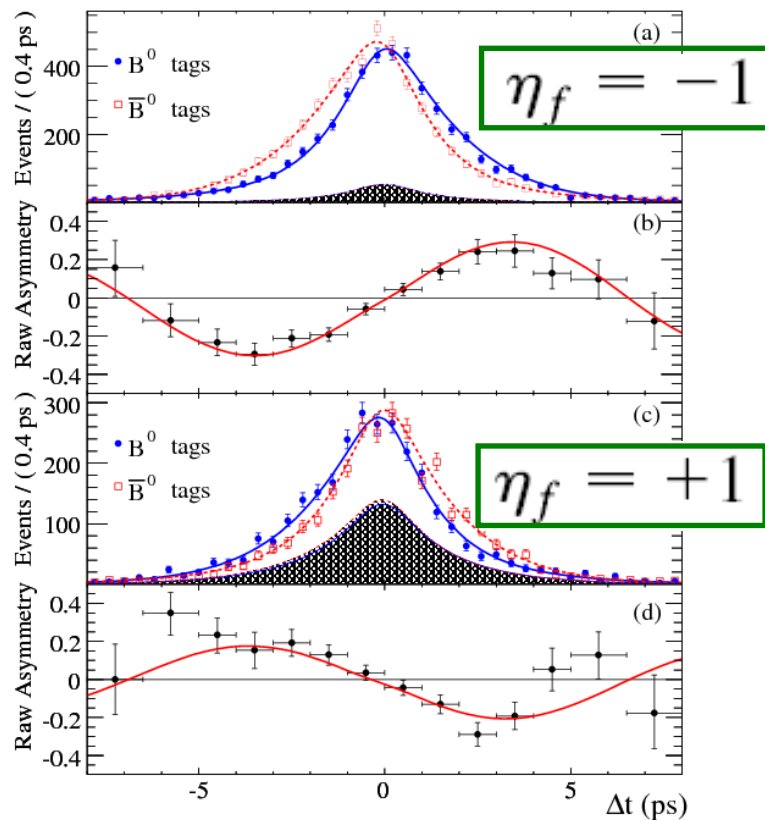

PRD 79 (2009) 072009

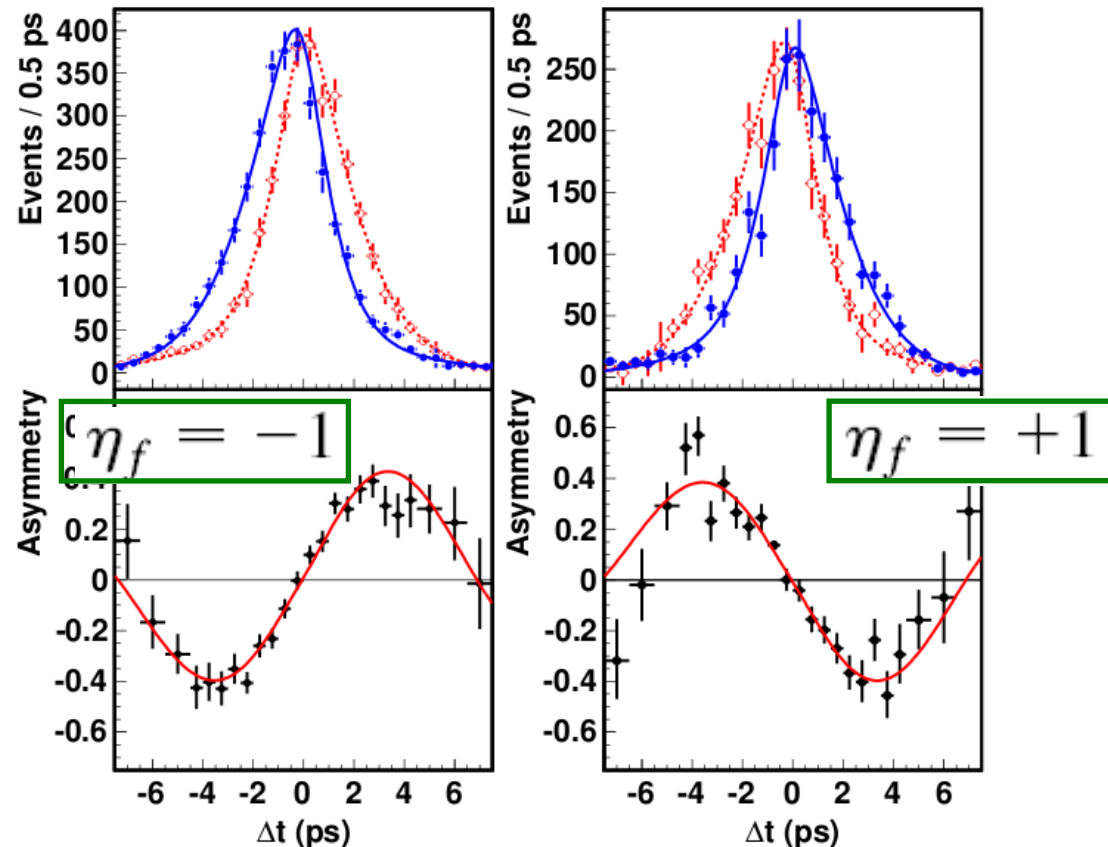

PRL 108 (2012) 171802

World average: $\sin(2\beta) = 0.679 \pm 0.020$

... and T is also violated, as expected

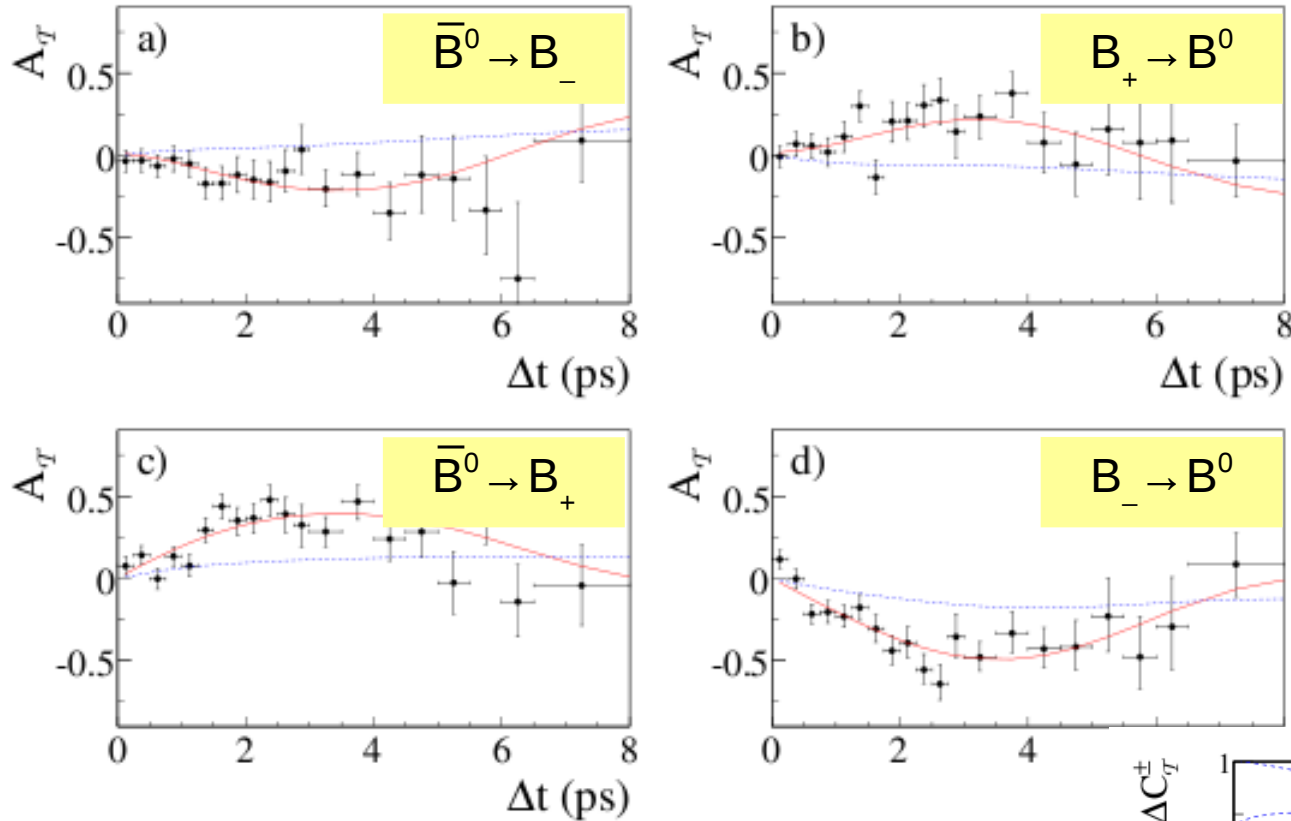

BaBar
PRL 109 (2012) 211801

Generalisation of usual $\sin(2\beta)$ analysis allowing for separate CP, T and CPT violating terms

No significant sign of CPT violation in any test

e.g. $A_T(\bar{B}^0 \rightarrow B_-)$ between $(l^- \text{ tag}, J/\psi K_S, \Delta t > 0)$
and $(l^+ \text{ tag}, J/\psi K_L, \Delta t < 0)$
 $\sim \frac{1}{2}(\Delta S_T^+ \sin(\Delta m_d \Delta t) + \Delta C_T^+ \cos(\Delta m_d \Delta t))$

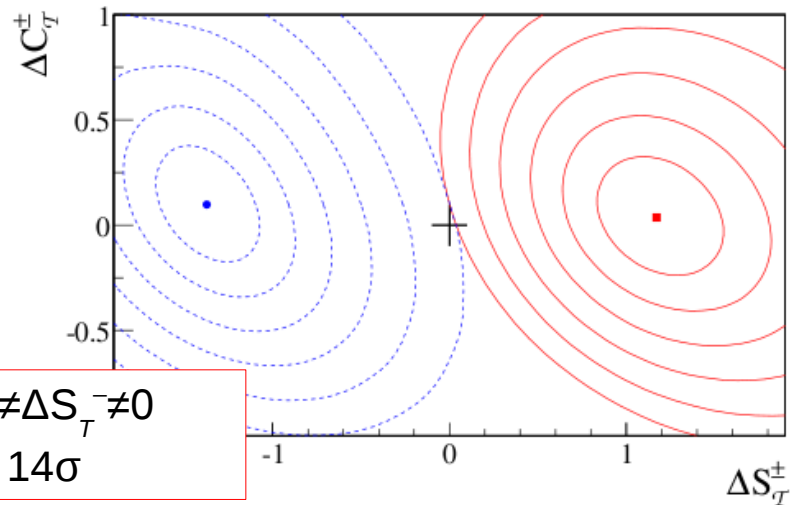

Contours show $\Delta S_T^+ \neq \Delta S_T^- \neq 0$
→ T violation at 14σ

Large *direct* CP violation effects also exist

LHCb-CONF-2012-018, -028

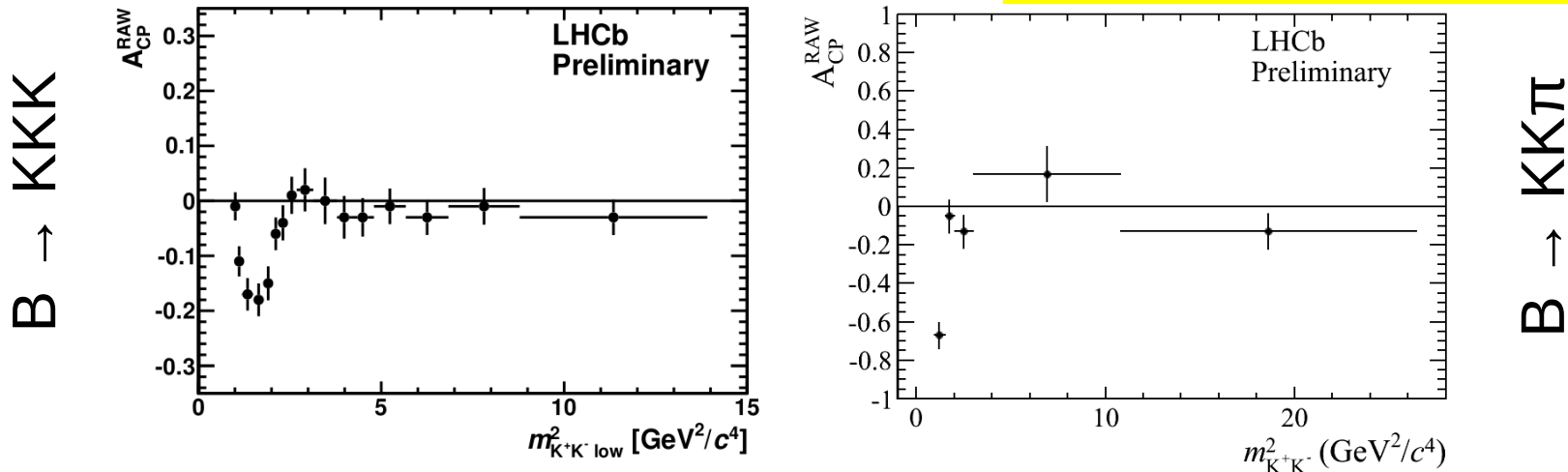

Large CP violation effects with strong variation across the Dalitz plot
Detailed studies in progress to understand origin of these effects

PLB 712 (2012) 203

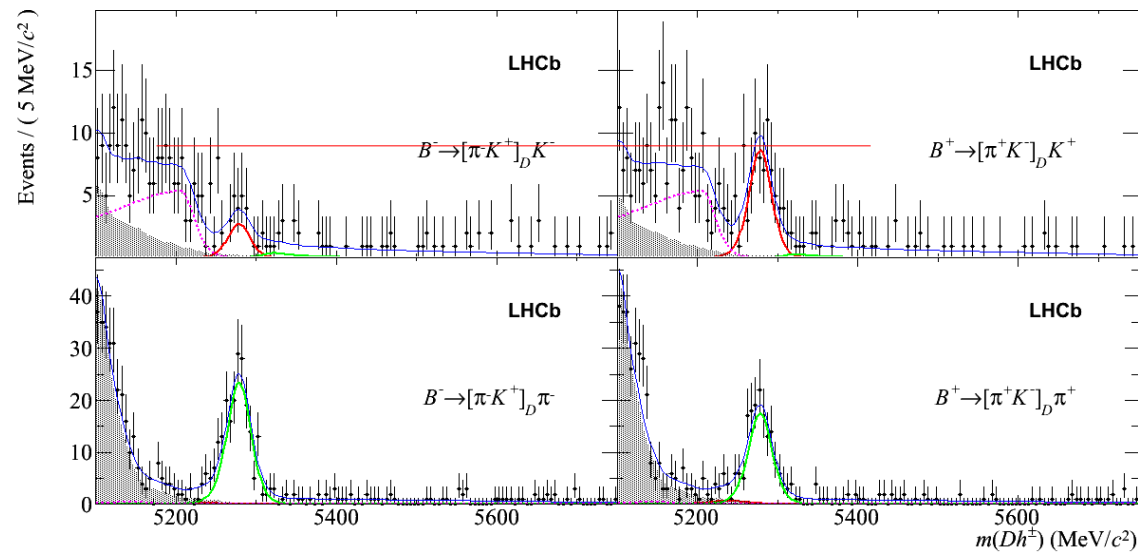

... also in B_s^0 decays

LHCb arXiv:1304.6173

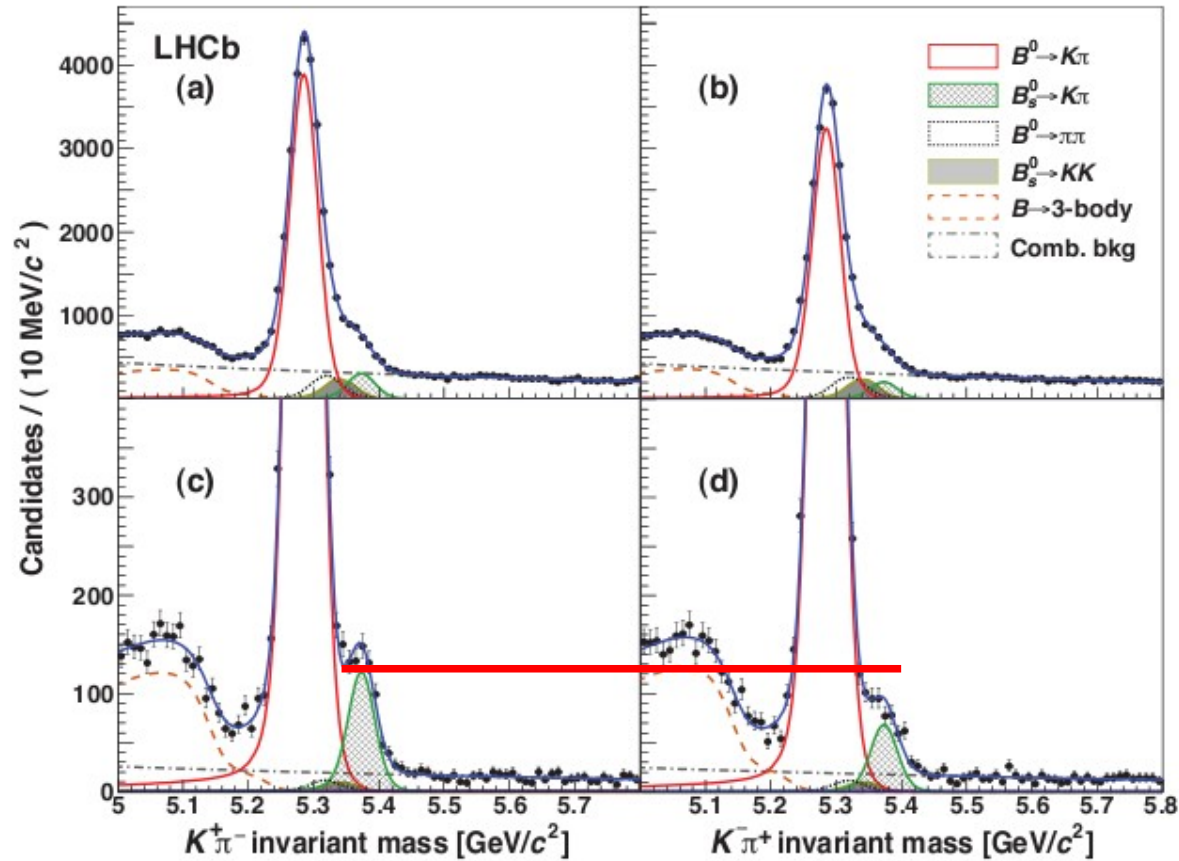

$$A_{CP}(B_s^0 \rightarrow K^- \pi^+) = 0.27 \pm 0.04 (\text{stat}) \pm 0.01 (\text{syst}).$$

5σ observation of CP violation in $B_s \rightarrow K\pi$ decays

γ from combination of $B^+ \rightarrow DK^+$ modes

BaBar PRD 87 (2013) 052015
Belle CKM2012 preliminary
LHCb-PAPER-2013-020
& LHCb-CONF-2013-006

- All direct CP violation effects caused by γ in the Standard Model
- Only those in $B \rightarrow DK$ type processes involve only tree-level diagrams
 - enable determination of γ with negligible theoretical uncertainty
- Several different B and D decays can be used
- Combination includes results from GLW/ADS ($D \rightarrow hh$) & GGSZ ($D \rightarrow K_s hh$)
- Sensitivity: BaBar & Belle each $\sim 16^\circ$; latest LHCb $\sim 12^\circ$

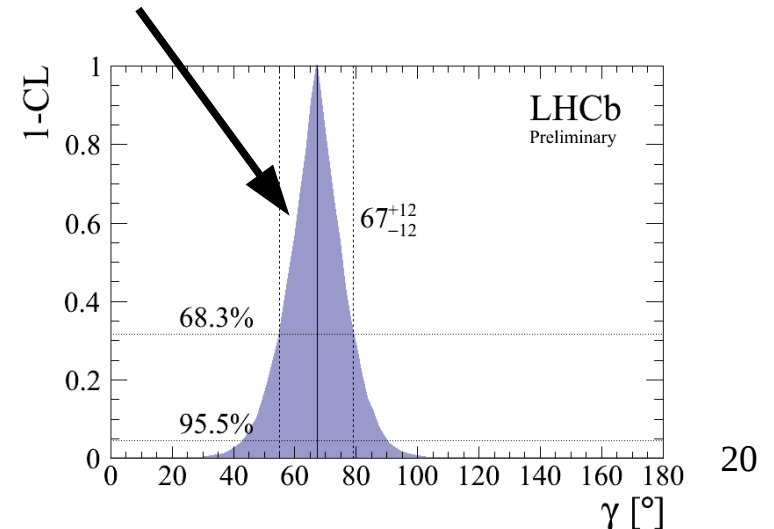
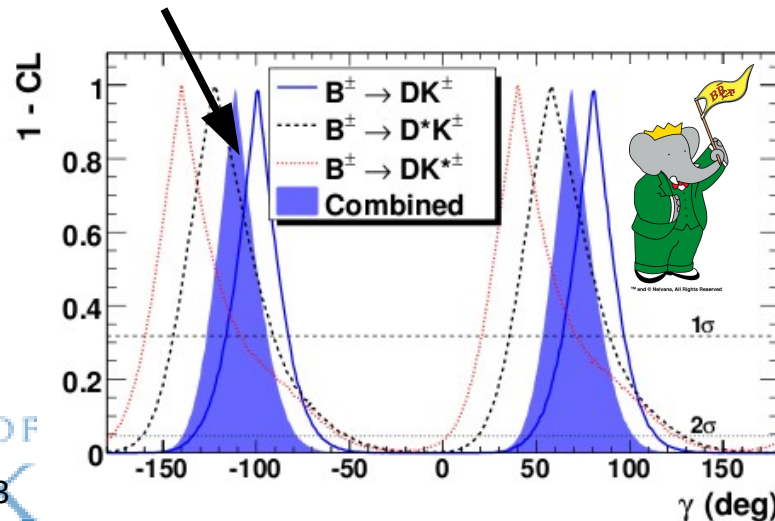

Neutral meson mixing – oscillation phenomena over 4 orders in magnitude

LHCb PRL 110 (2013) 101802

LHCb arXiv:1304.4741

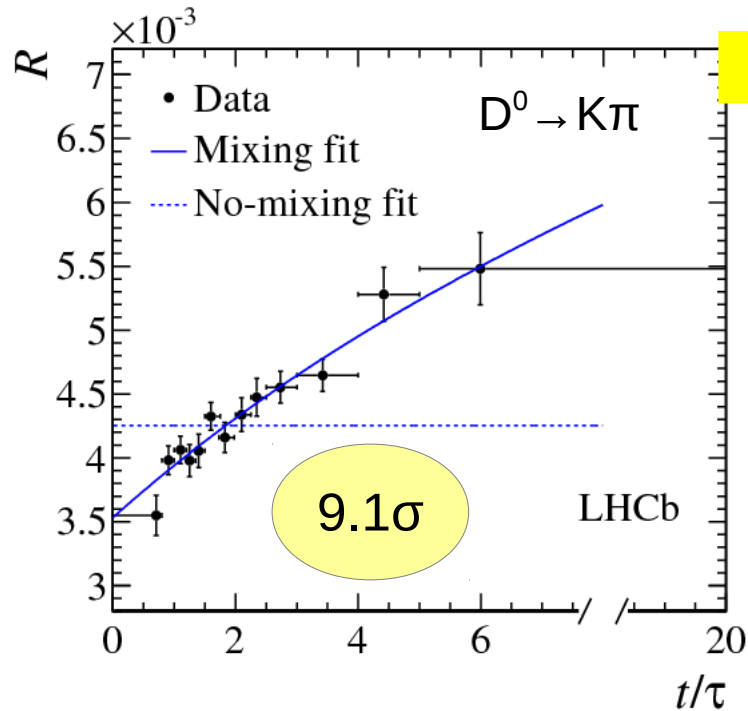

LHCb PLB 719 (2013) 318

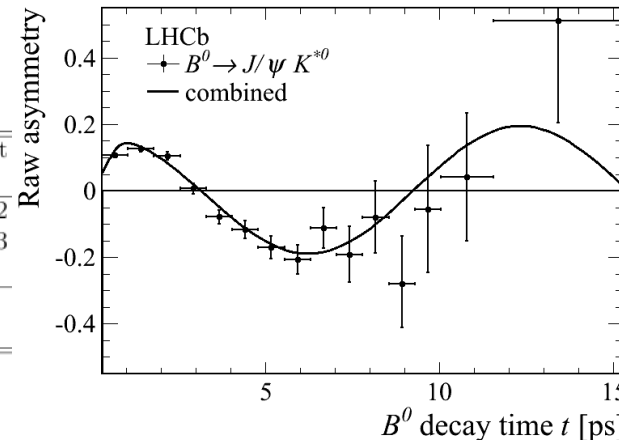
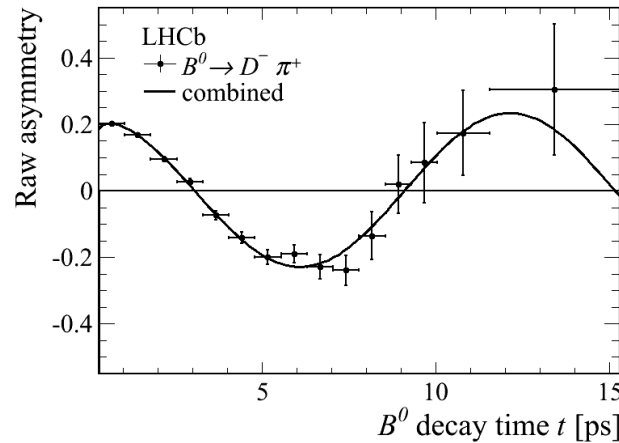

$B_s^0 \rightarrow D_s \pi$

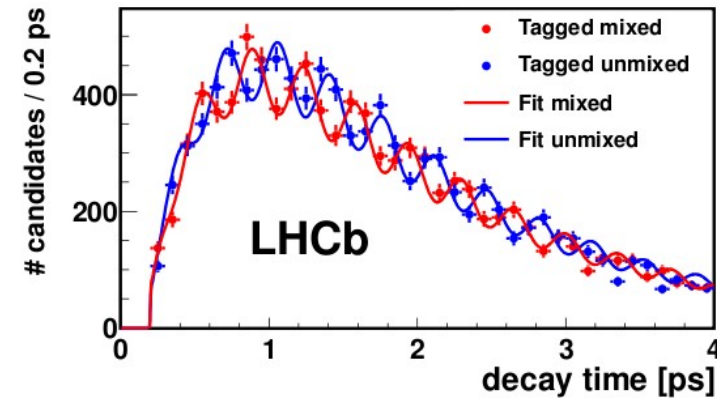

$\Delta m_s = (17.768 \pm 0.023 \text{ (stat)} \pm 0.006 \text{ (syst)}) \text{ ps}^{-1}$
 O(%) precision & still statistically limited

Fit type (χ^2/ndf)	Parameter	Fit result (10^{-3})	Correlation coefficient		
			R_D	y'	x'^2
Mixing (9.5/10)	R_D	3.52 ± 0.15	1	-0.954	+0.882
	y'	7.2 ± 2.4		1	-0.973
	x'^2	-0.09 ± 0.13			1
No mixing (98.1/12)	R_D	4.25 ± 0.04			

Is there CP violation in B mixing?

Semileptonic asymmetries in both B_d and B_s systems negligibly small in the SM

D0 PRD 84 (2011) 052007

Results of inclusive dimuon asymmetry analysis 3.9σ from SM

Systematics reduced by magnet polarity inversions, and from use of control samples, such as single muon sample

$$A_{sl}^b = (0.594 \pm 0.022) a_{sl}^d + (0.406 \pm 0.022) a_{sl}^s$$

Constraint in $a_{sl}^d - a_{sl}^s$ plane obtained from oscillated B_d or B_s enriched samples (cutting on impact parameter)

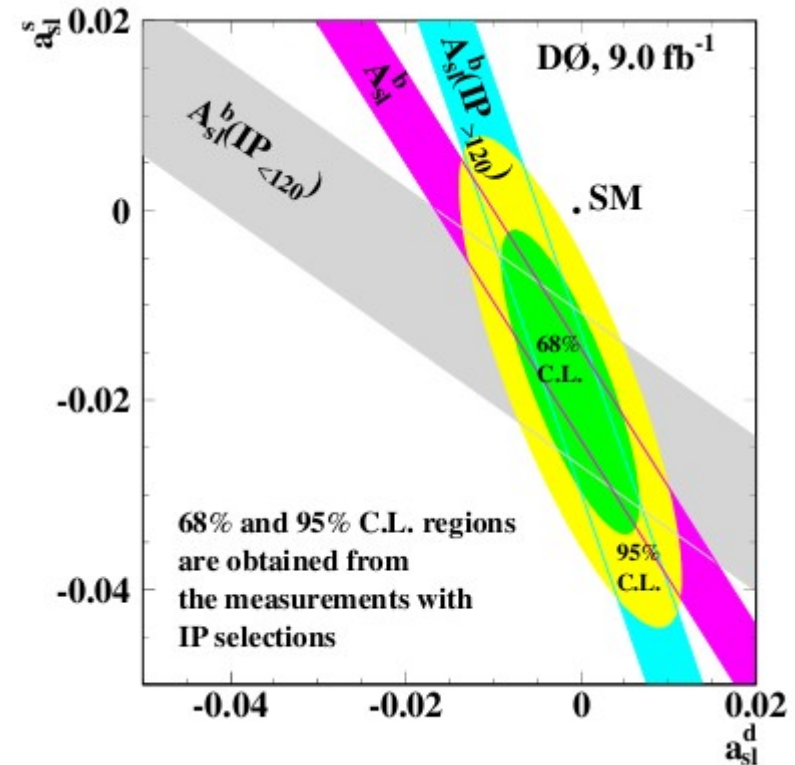

Is there CP violation in B *mixing*?

Semileptonic asymmetries in both B_d and B_s systems negligibly small in the SM

D0 PRD 84 (2011) 052007,
PRL 110 (2013) 011801,
PRD 86 (2012) 072009

Results of inclusive dimuon asymmetry analysis 3.9σ from SM

Including results on a_{sl}^d and a_{sl}^s individually (from $D^{(*)+}\mu^- \nu X$ and $D_s^{*+}\mu^- \nu X$ samples) puts combination at 2.9σ from SM

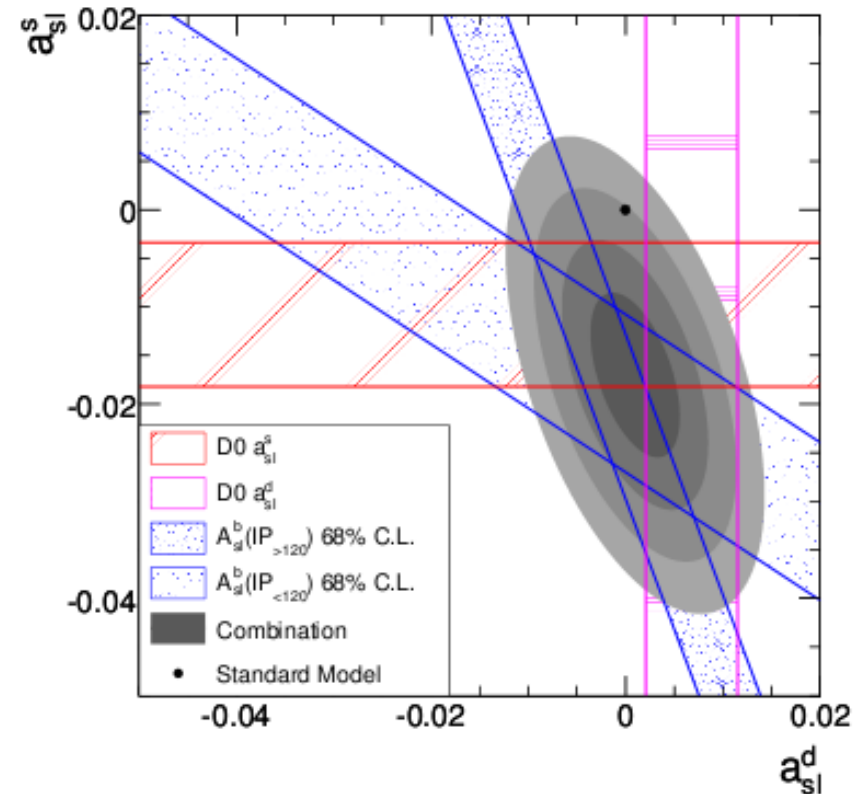

Is there CP violation in B *mixing*?

Semileptonic asymmetries in both B_d and B_s systems negligibly small in the SM

Results of inclusive dimuon asymmetry analysis 3.9σ from SM

Including results on a_{sl}^d and a_{sl}^s individually (from $D^{(*)+}\mu^- \nu X$ and $D_s^+ \mu^- \nu X$ samples) puts combination at 2.9σ from SM

Including B factory a_{sl}^d and LHCb a_{sl}^s results give average 2.4σ from the SM

Situation unclear – improved measurements needed

Must prepare for $\%o$ level measurements

D0 PRD 84 (2011) 052007,
PRL 110 (2013) 011801,
PRD 86 (2012) 072009
LHCb-CONF-2012-022
BaBar CKM2012 preliminary

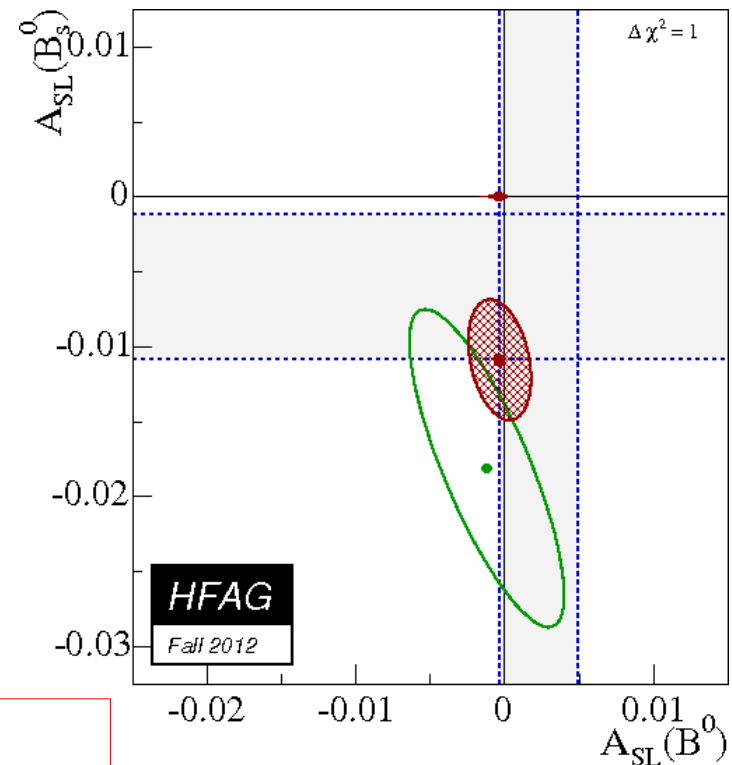

Warning: scale changed from previous slide

Improved measurements of B_s oscillations and CP violation

LHCb arXiv:1304.2600

$B_s \rightarrow J/\psi KK$ (& $J/\psi \pi\pi$)

LHCb arXiv:1303.7125

$B_s \rightarrow \phi\phi$

Start to compare tree-level decays with much rarer penguin processes \rightarrow sensitive test with higher statistics

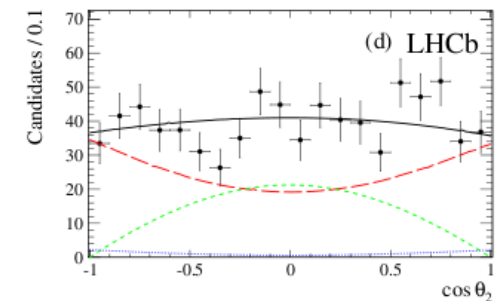
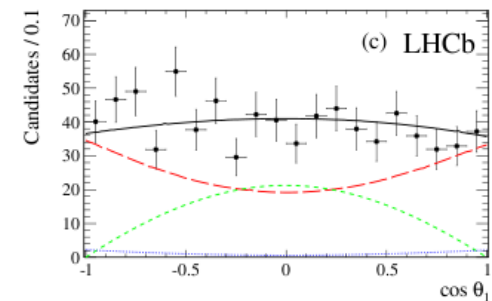
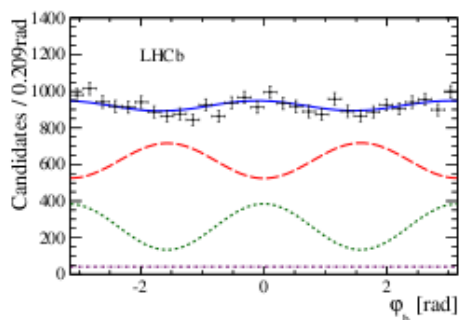
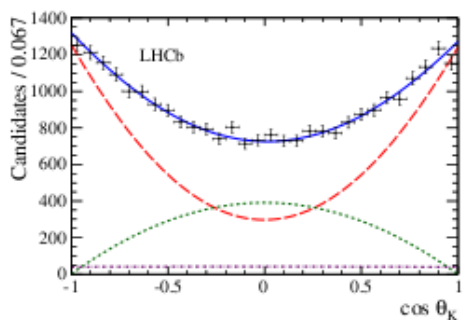
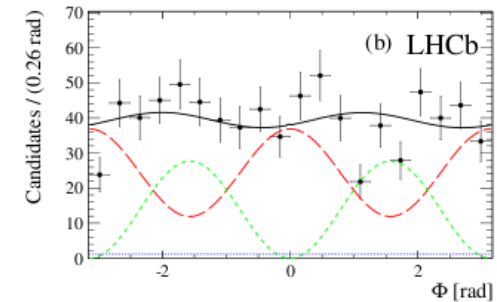
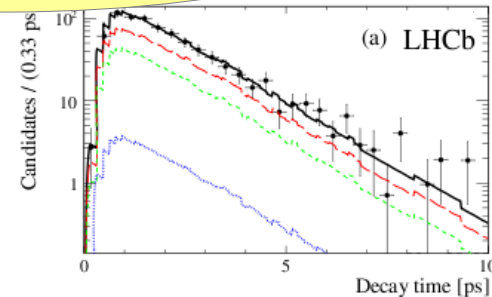
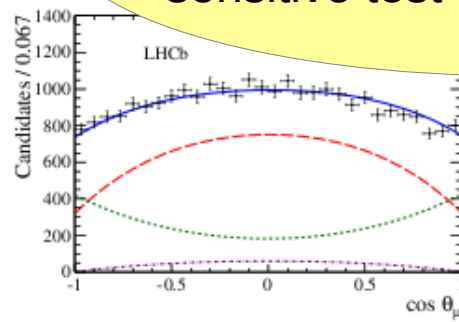
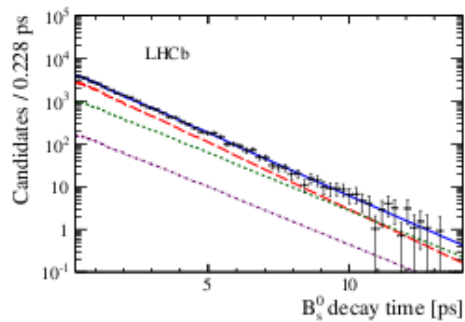

$$\phi_s = 0.01 \pm 0.07 \text{ (stat)} \pm 0.01 \text{ (syst) rad,}$$

$$\Gamma_s = 0.661 \pm 0.004 \text{ (stat)} \pm 0.006 \text{ (syst) ps}^{-1},$$

$$\Delta\Gamma_s = 0.106 \pm 0.011 \text{ (stat)} \pm 0.007 \text{ (syst) ps}^{-1}.$$

Improved measurements of B_s lifetimes and CP violation

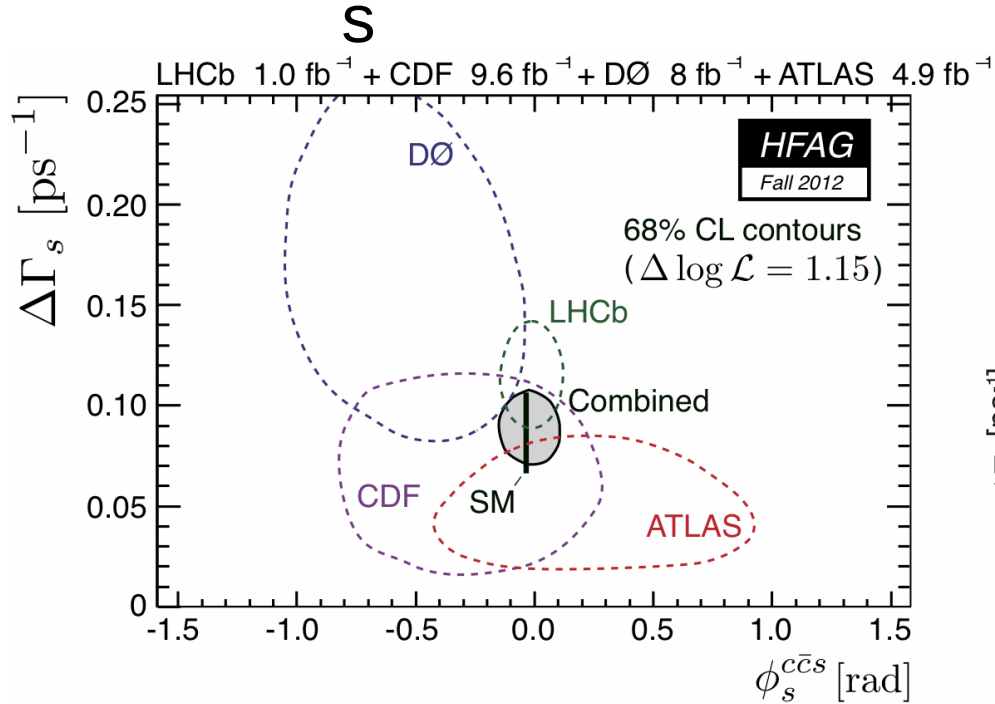

LHCb arXiv:1304.2600
 CDF PRD 85 (2012) 072002
 D0 PRD 85 (2012) 032006
 ATLAS JHEP 12 (2012) 072 &
 ATLAS-CONF-2013-039

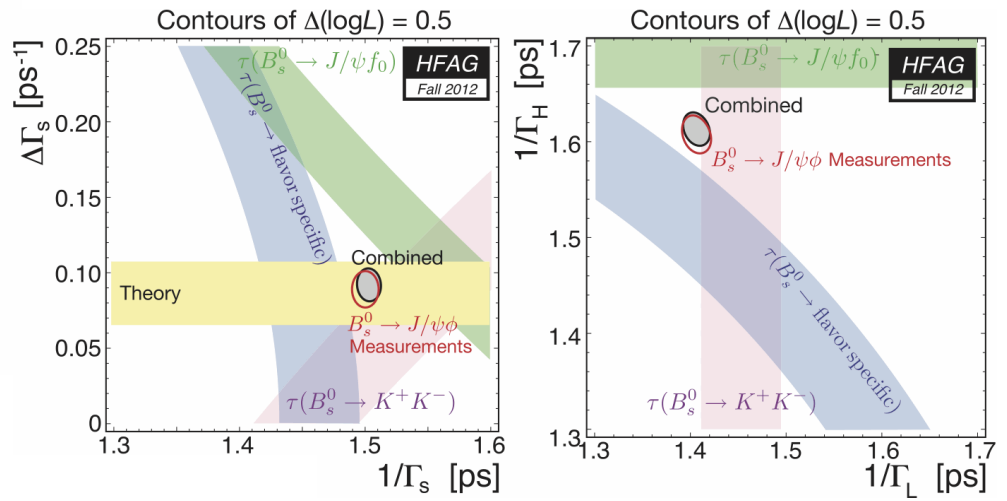

N.B. Improved Λ_b lifetime measurements of great interest:

D0 PRD 85 (2012) 112003
 ATLAS PRD 87 (2013) 032002
 CMS arXiv:1304.7495

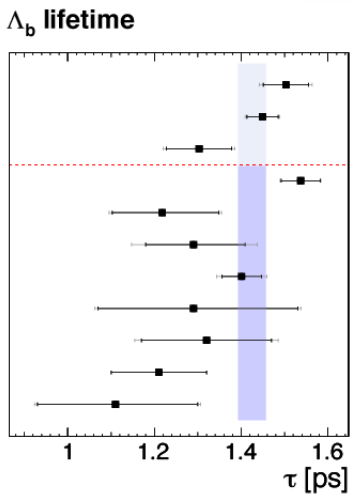

Experiment	Period	Channel
CMS prel.	(2011)	$J/\psi\Lambda$
ATLAS	(2011)	$J/\psi\Lambda$
D0	(02-11)	$J/\psi\Lambda$
CDF2	(02-09)	$J/\psi\Lambda$
D0	(02-06)	$J/\psi\Lambda$
D0	(02-06)	$\Lambda_{cb}^0\Lambda$
CDF2	(02-06)	$\Lambda_{cb}^0\tau$
OPAL	(90-95)	$\Lambda_{cb}^0, \Lambda\tau^+$
CDF1	(91-95)	Λ_{cb}^0
ALEPH	(91-95)	Λ
DELPHI	(91-94)	Λ_{cb}^0

errors in black: statistical only
 errors in grey: syst. added in quadrature
 band: current best value (PDG)
 - - - values below used for best value

J. Beringer et al. (Particle Data Group)
 Phys. Rev. D86, 010001 (2012)

... tensions with expectations reduced

Is there CP violation in the charm system? (and if so, where does it come from?)

To reduce systematics and (perhaps) enhance CP violation effect, experiments measure

LHCb arXiv:1303.2614, LHCb-CONF-2013-003
CDF PRL 109 (2012) 111801
Belle ICHEP preliminary

$$\begin{aligned} \Delta A_{CP} &\equiv A_{CP}(K^- K^+) - A_{CP}(\pi^- \pi^+) \\ &= [a_{CP}^{\text{dir}}(K^- K^+) - a_{CP}^{\text{dir}}(\pi^- \pi^+)] + \frac{\Delta\langle t \rangle}{\tau} a_{CP}^{\text{ind}}. \end{aligned}$$

ΔA_{CP} related mainly to direct CP violation
(contribution from indirect CPV suppressed by difference in mean decay time)

$$\Delta a_{CP}^{\text{dir}} = (-0.33 \pm 0.12)\%$$

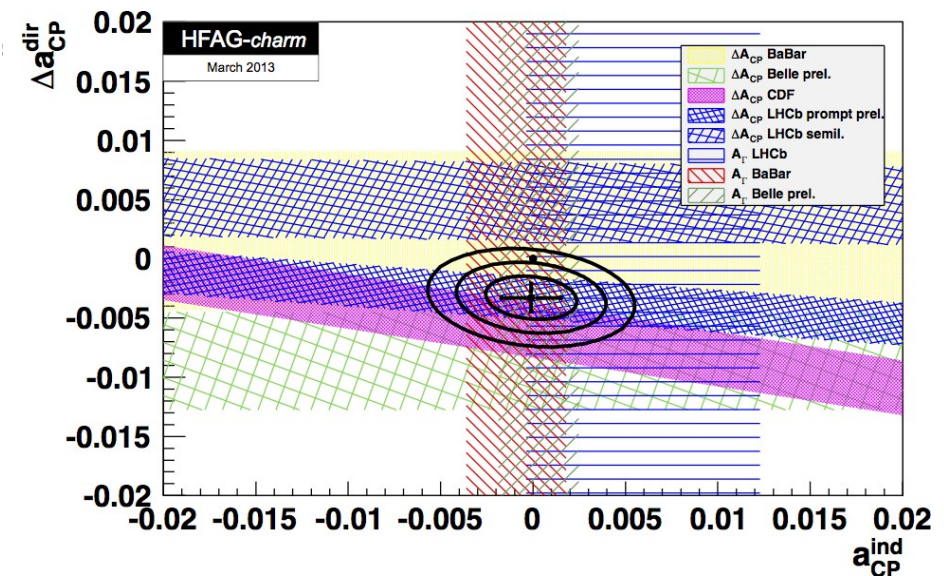

Previous evidence for CPV
not confirmed
Need more precise measurements

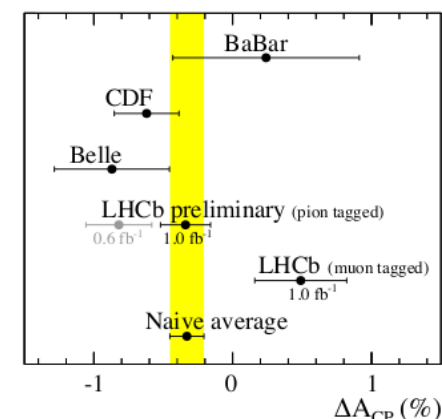
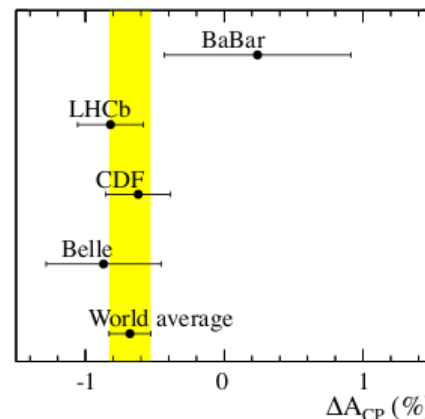

B → TV & B → D^(*)TV

BaBar arXiv:1207.0698
 Belle arXiv:1208.4678
 M. Nakao @ ICHEP 2012

BaBar PRL 109 (2012) 101802
 Belle PRD 82 (2010) 072005

- BaBar [468M] (2010) semilep-tag
- BaBar [468M] (2012) hadronic-tag
- BaBar (combined) with correlations
- Belle [657M] (2010) semilep-tag
- Belle [772M] (2012) hadronic-tag
- Belle (combined) with correlations
- W.A. private average (MN)

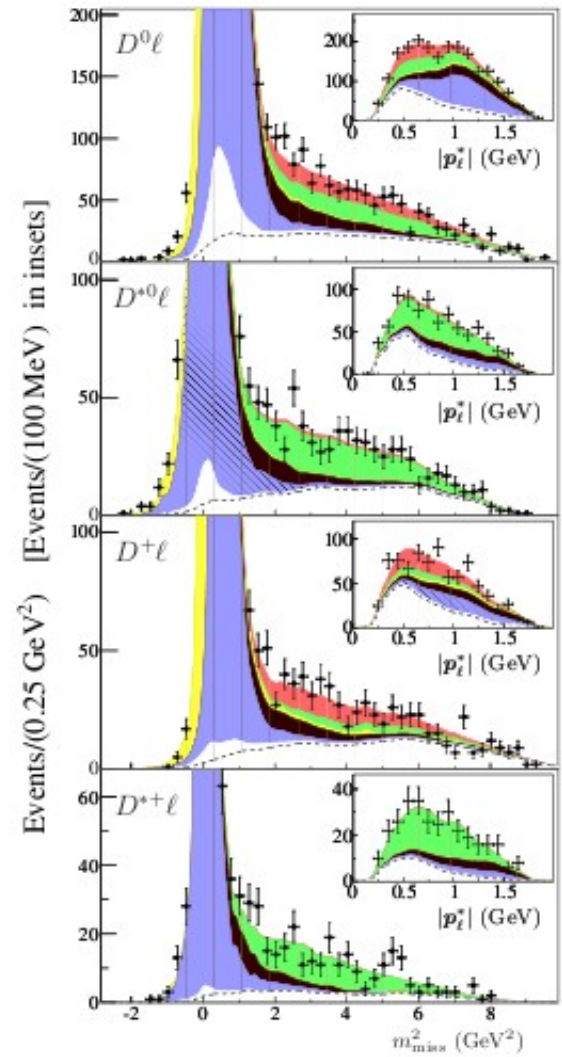
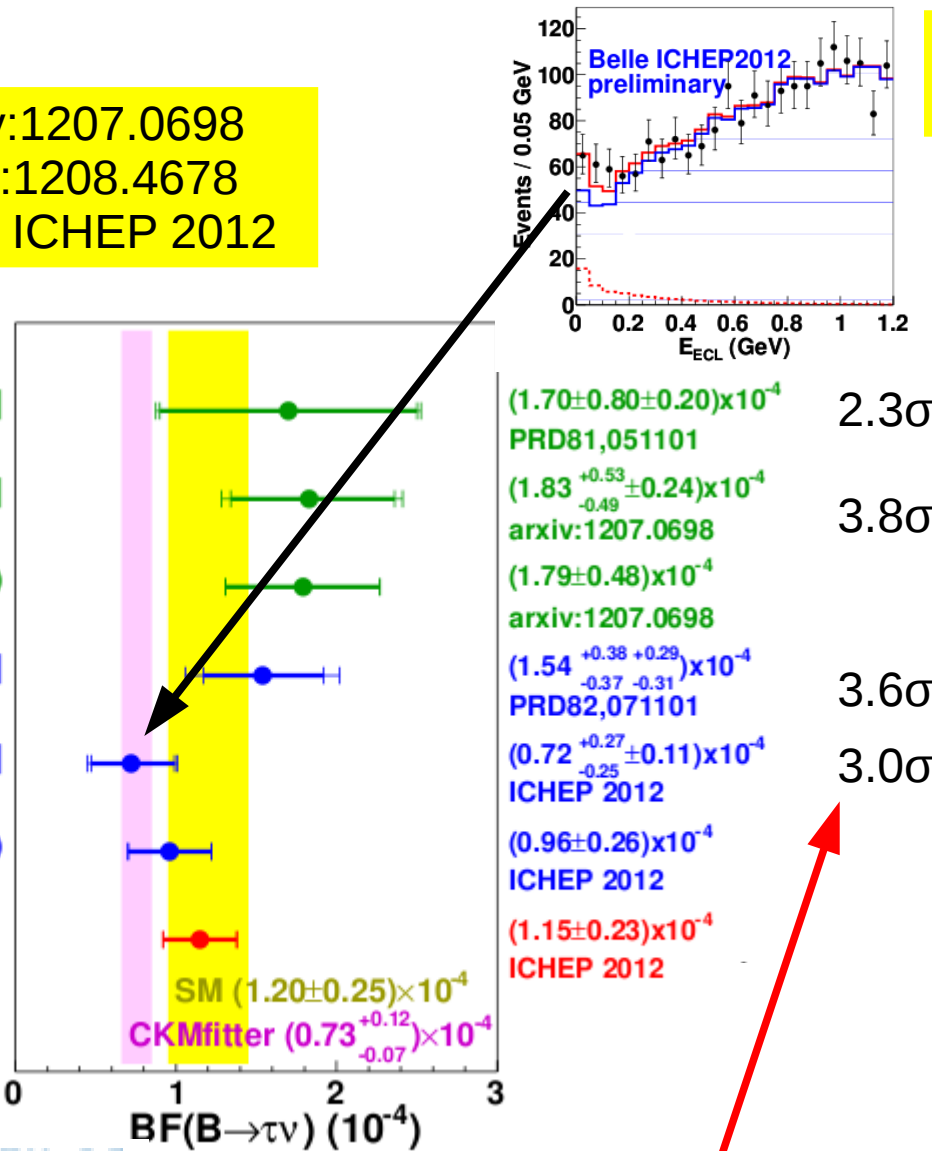

BaBar rates 3.4σ above the SM, and inconsistent with 2HDM

Significance (from 0) below the usual threshold to claim observation

Selected highlights of results Rare Decays

$$B_s \rightarrow \mu^+ \mu^-$$

Killer app. for new physics discovery

Very rare in Standard Model due to

- absence of tree-level FCNC
 - helicity suppression
 - CKM suppression
- ... all features which are not necessarily reproduced in extended models

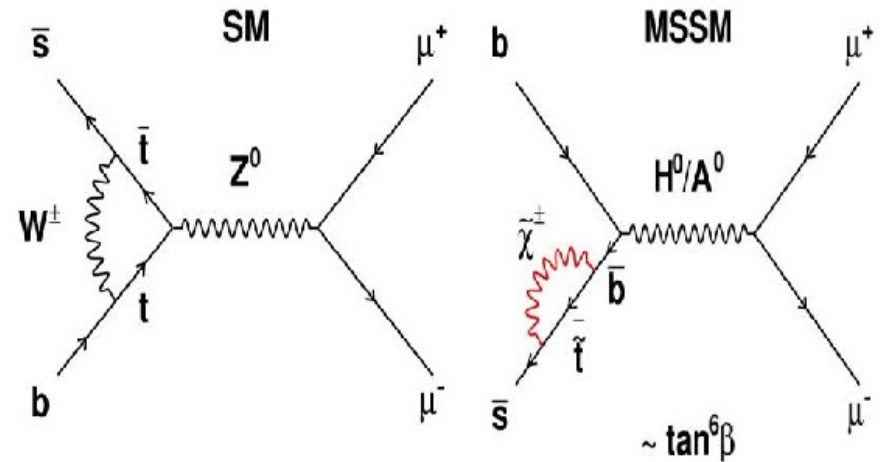

$$B(B_s \rightarrow \mu^+ \mu^-)^{SM} = (3.2 \pm 0.3) \times 10^{-9}$$

$$B(B_s \rightarrow \mu^+ \mu^-)^{MSSM} \sim \tan^6 \beta / M_{A^0}^4$$

Buras et al, EPJ C72 (2012) 2172

N.B. Should be corrected up by 9% since measurement is of the time-integrated branching fraction (PRL 109 (2012) 041801)

Latest results on $B_s \rightarrow \mu^+ \mu^-$

ATLAS (2.4/fb)
PLB 713 (2012) 387

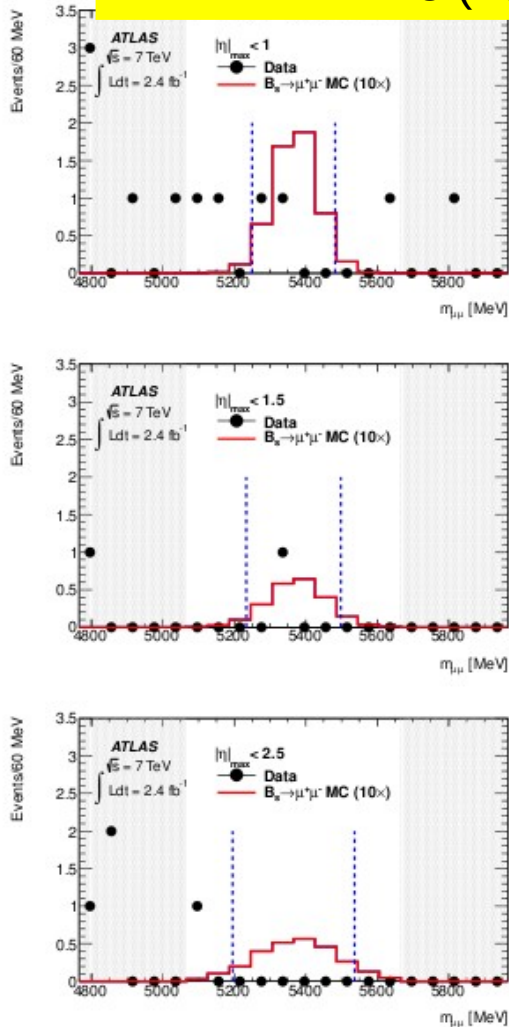

CMS (5/fb)
JHEP 04 (2012) 033

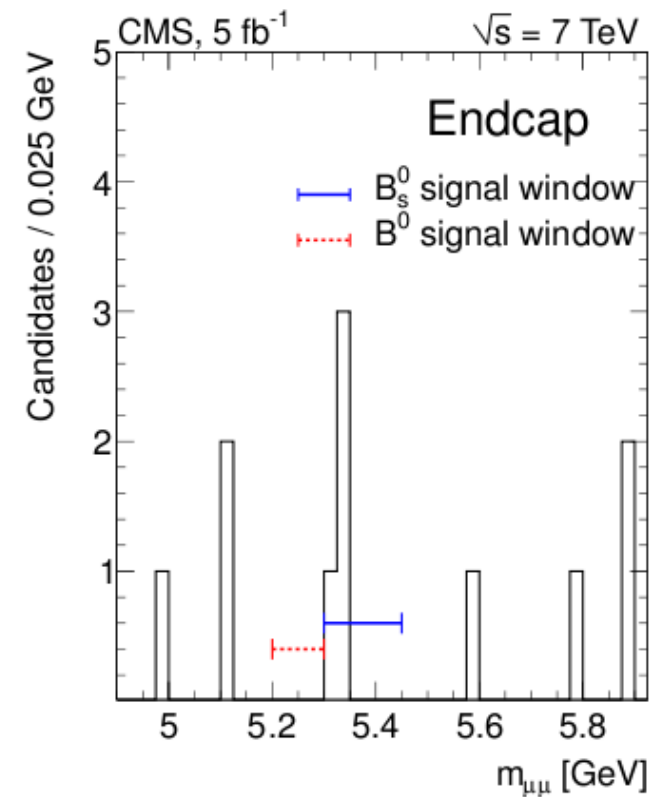
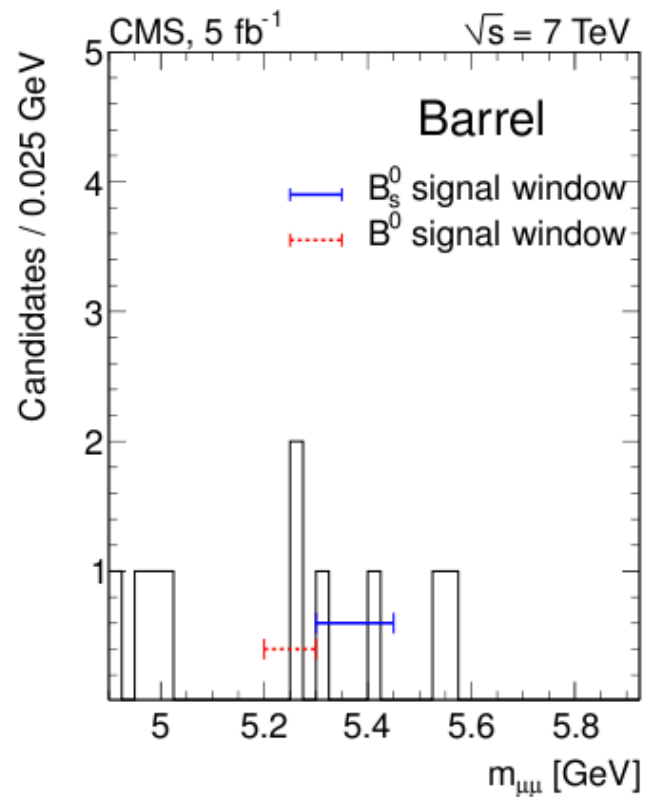

ATLAS $B(B_s \rightarrow \mu^+ \mu^-) < 2.2 \text{ (1.9)} \times 10^{-8}$ @ 95% (90%) CL
CMS $B(B_s \rightarrow \mu^+ \mu^-) < 7.7 \text{ (6.4)} \times 10^{-9}$ @ 95% (90%) CL

Latest results on $B_s \rightarrow \mu^+ \mu^-$

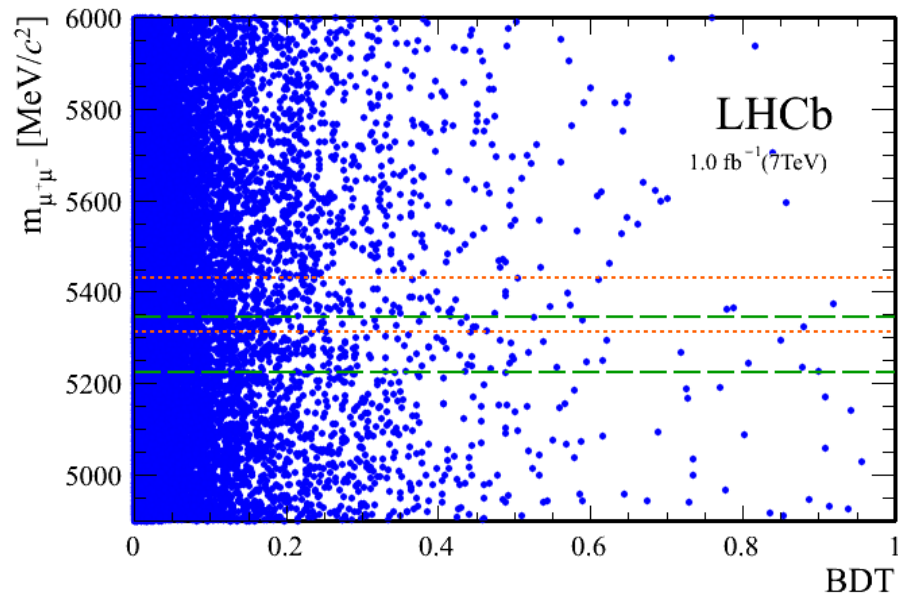

LHCb (2/fb)
PRL 110 (2013) 021801

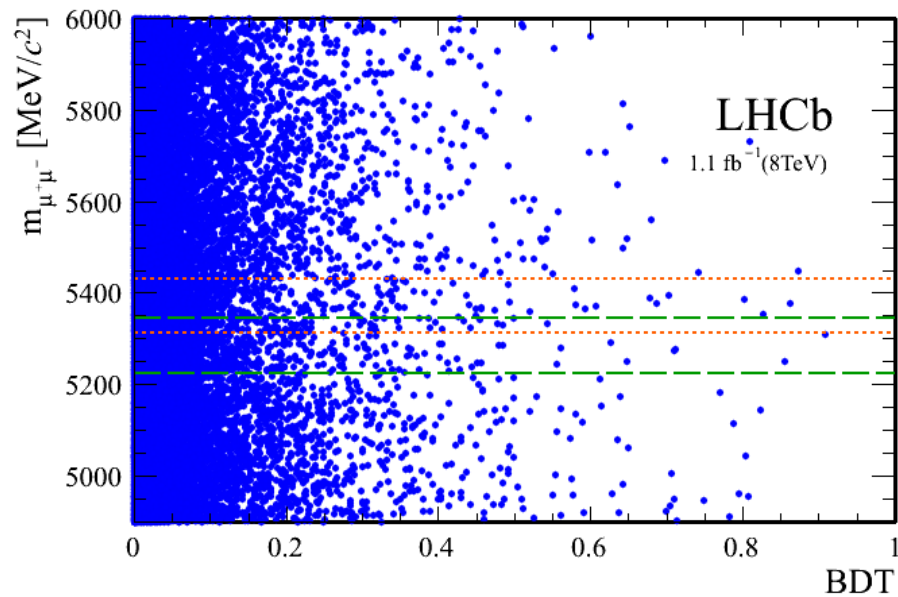

Latest results on $B_s \rightarrow \mu^+ \mu^-$

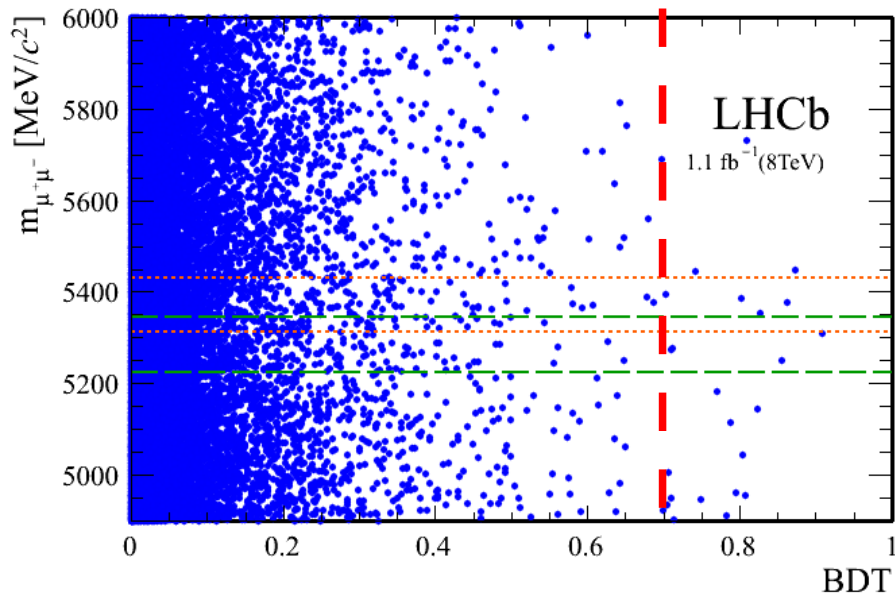
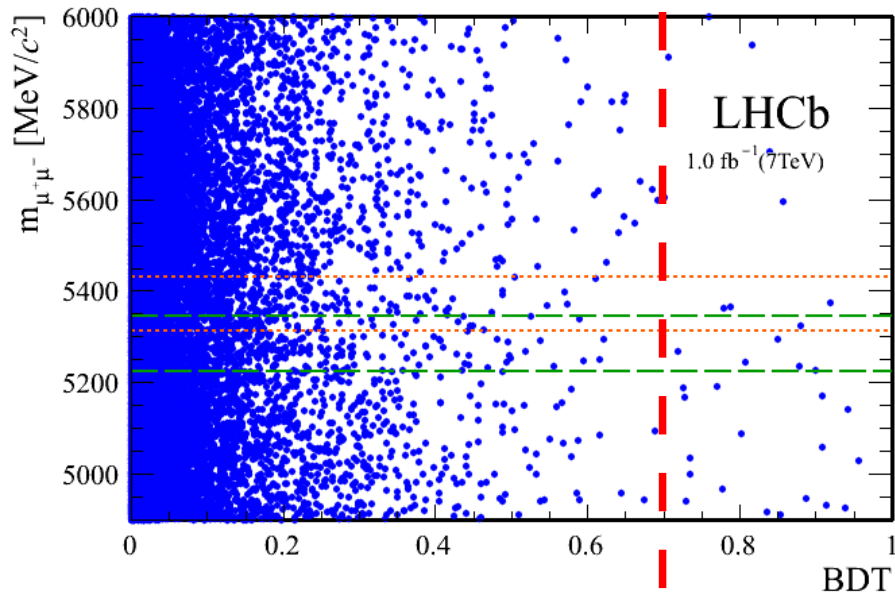

LHCb (2/fb)
PRL 110 (2013) 021801

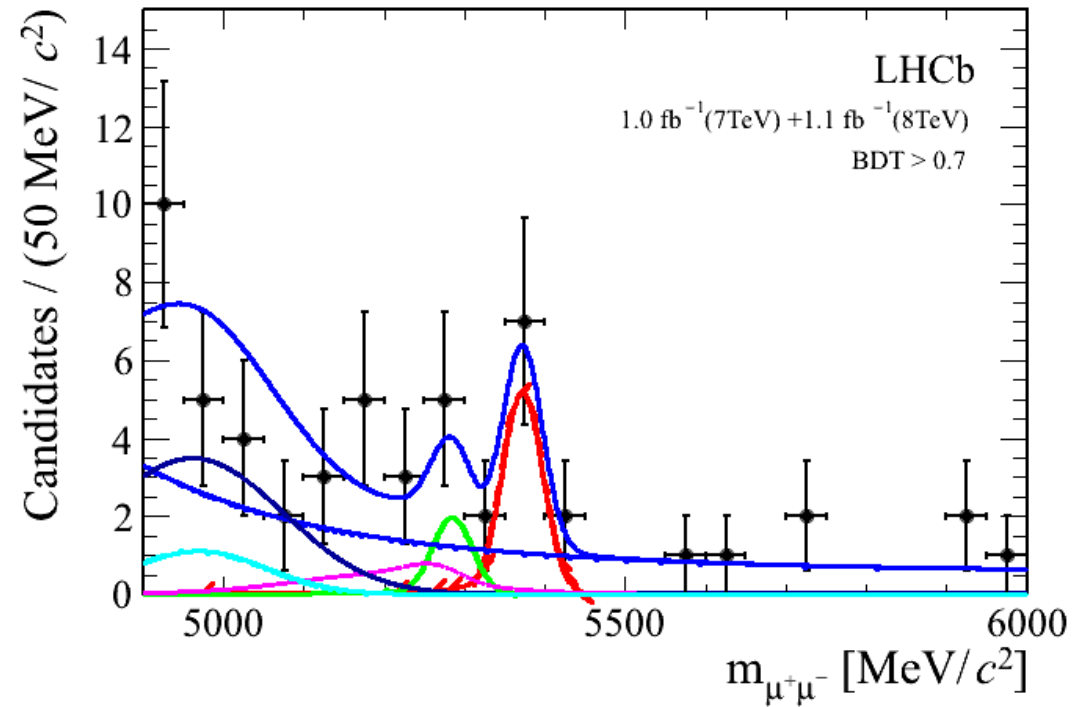

$$B(B_s^0 \rightarrow \mu^+ \mu^-) = (3.2_{-1.2}^{+1.4}(\text{stat})_{-0.3}^{+0.5}(\text{syst})) \times 10^{-9}$$

3.5 σ

Impact of $B_s \rightarrow \mu^+ \mu^-$

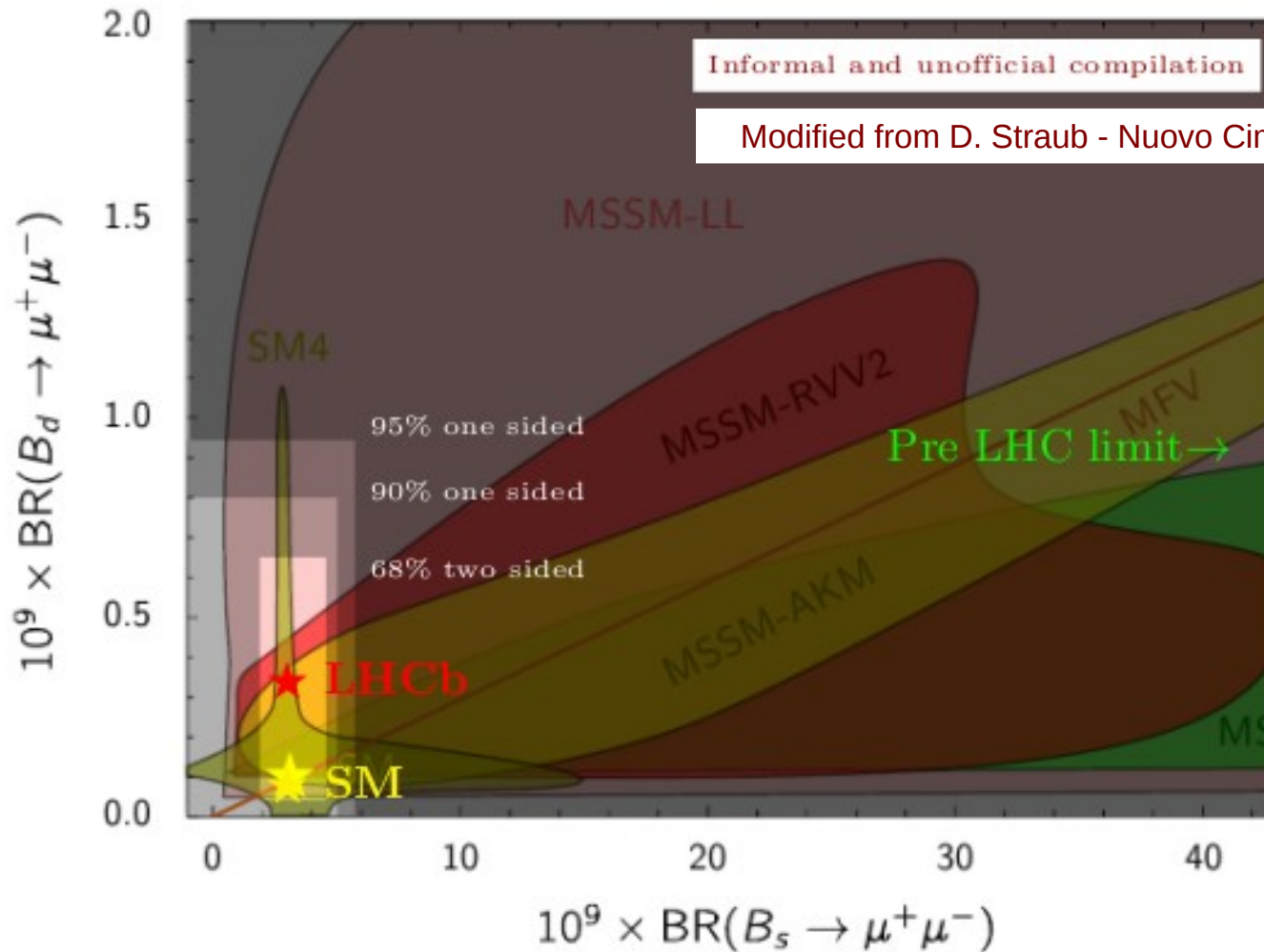

$$B \rightarrow K^* \mu^+ \mu^-$$

- $B_d \rightarrow K^{*0} \mu^+ \mu^-$ provides complementary approach to search for new physics in $b \rightarrow s l^+ l^-$ FCNC processes
 - rates, angular distributions and asymmetries sensitive to NP
 - superb laboratory for NP tests
 - **experimentally clean signature**
 - many kinematic variables ...
 - ... **with clean theoretical predictions**

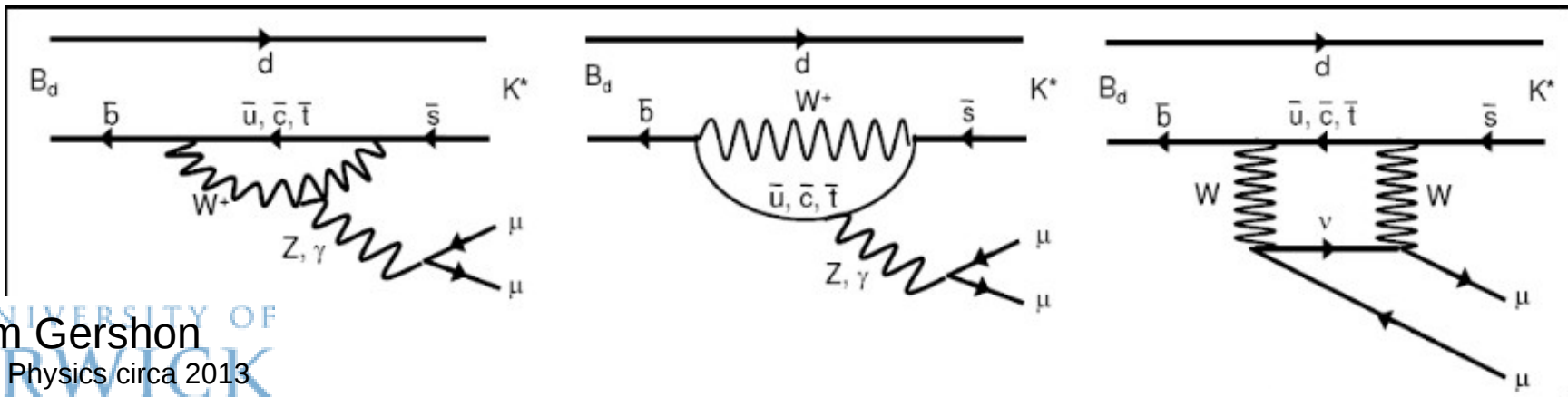

Angular analysis of $B^0 \rightarrow K^{*0} \mu^+ \mu^-$

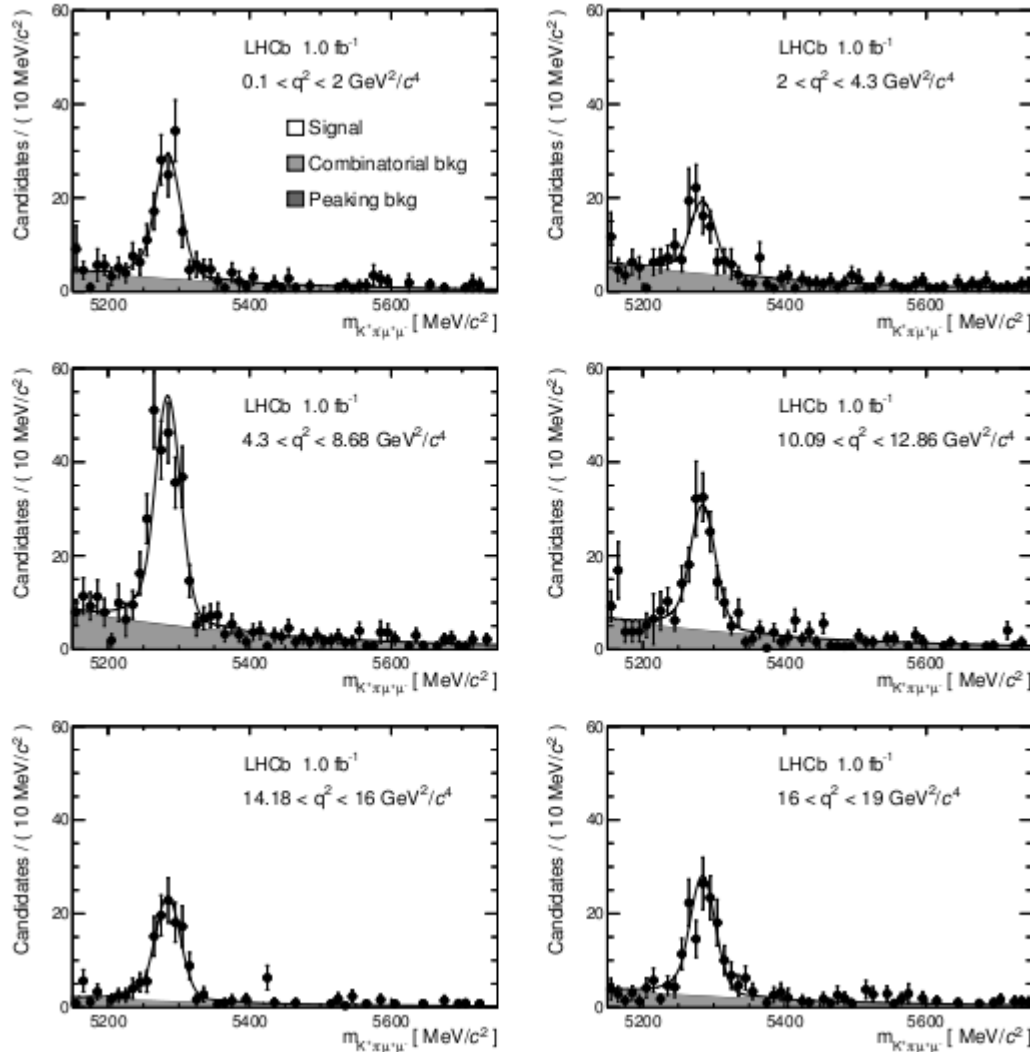

LHCb arXiv:1304.6325
 See also CDF PRL 108 (2012) 081807
 BaBar PRD 86 (2012) 032012
 ATLAS-CONF-2013-038 & CMS BPH-11-009

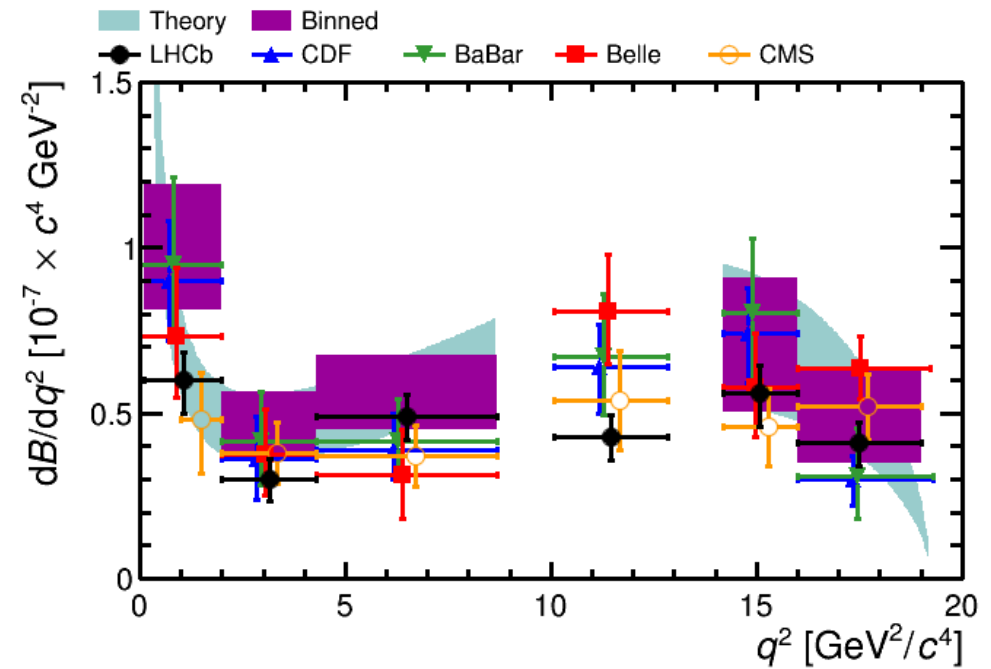

Analysis performed in bins of dimuon invariant mass squared (q^2)

Angular analysis of $B^0 \rightarrow K^{*0} \mu^+ \mu^-$

LHCb arXiv:1304.6325
 See also CDF PRL 108 (2012) 081807
 BaBar PRD 86 (2012) 032012
 ATLAS-CONF-2013-038 & CMS BPH-11-009

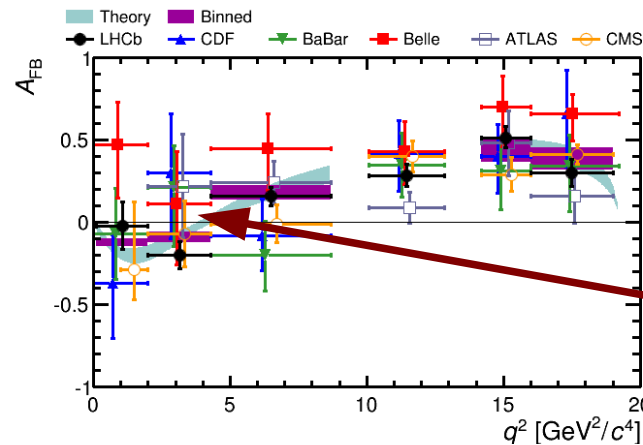
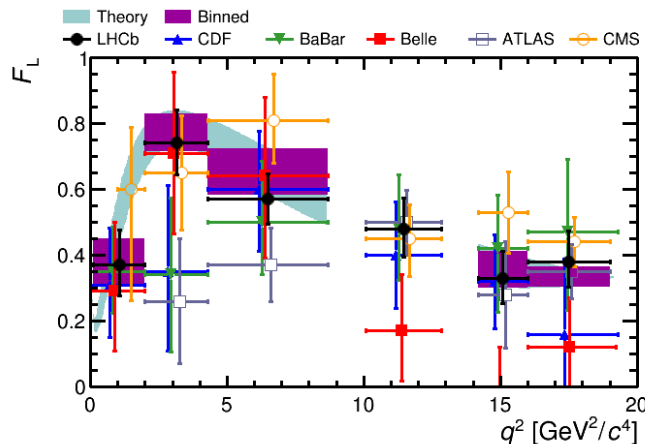

First measurement of zero-crossing point of A_{FB}

$$q_0^2 = (4.9 \pm 0.9) \text{ GeV}^2/c^4$$

Consistent with SM expectation

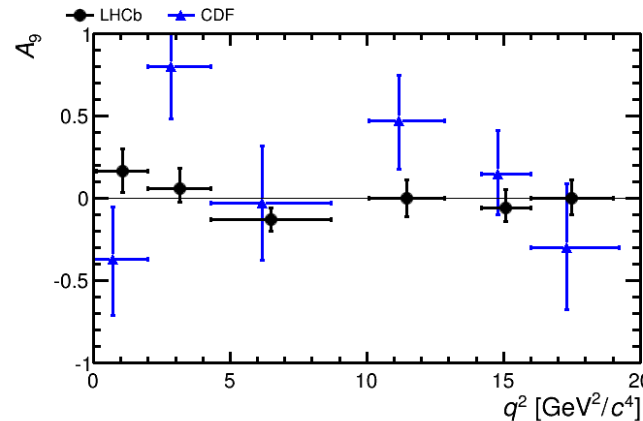
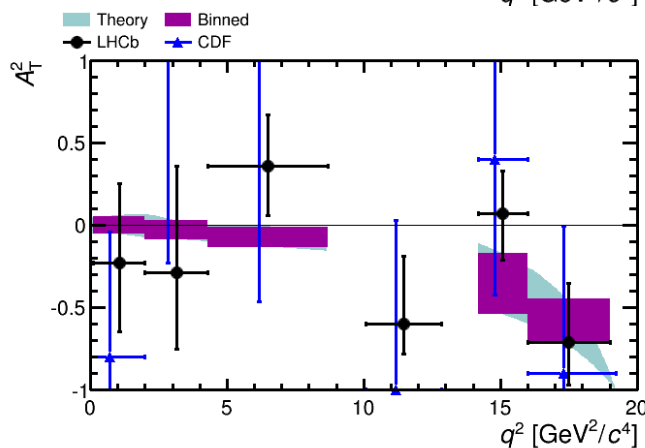

Isospin asymmetry in $B \rightarrow K^{(*)}\mu\mu$

LHCb JHEP 07 (2012) 133

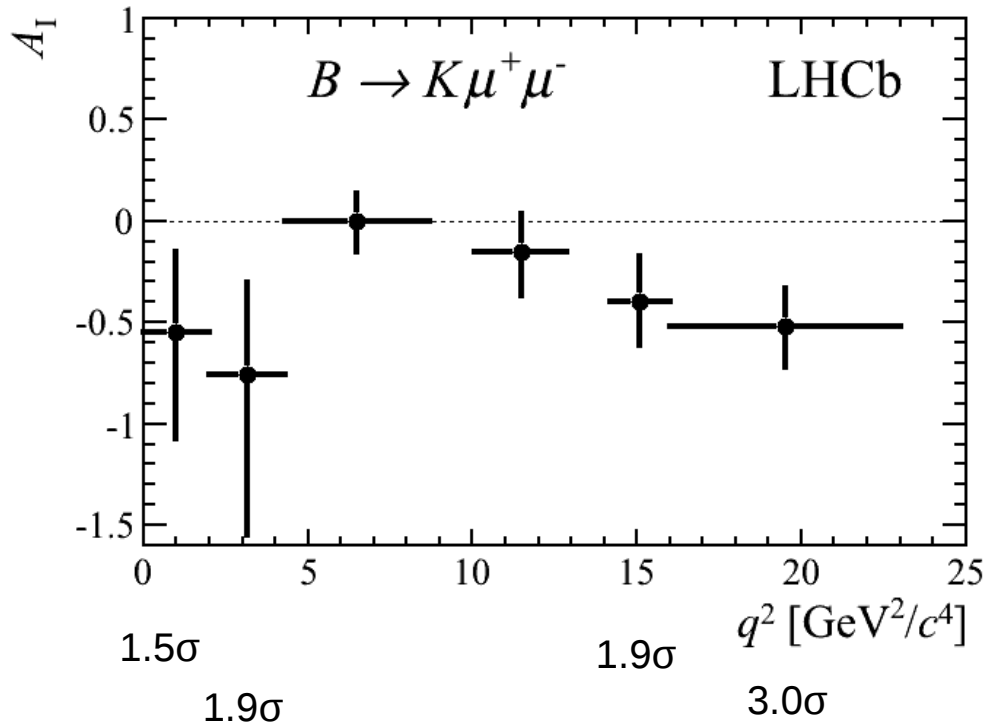

Deviation from zero integrated over $q^2 \sim 4.4\sigma$
 Consistent with previous measurements
 (BaBar, Belle, CDF)

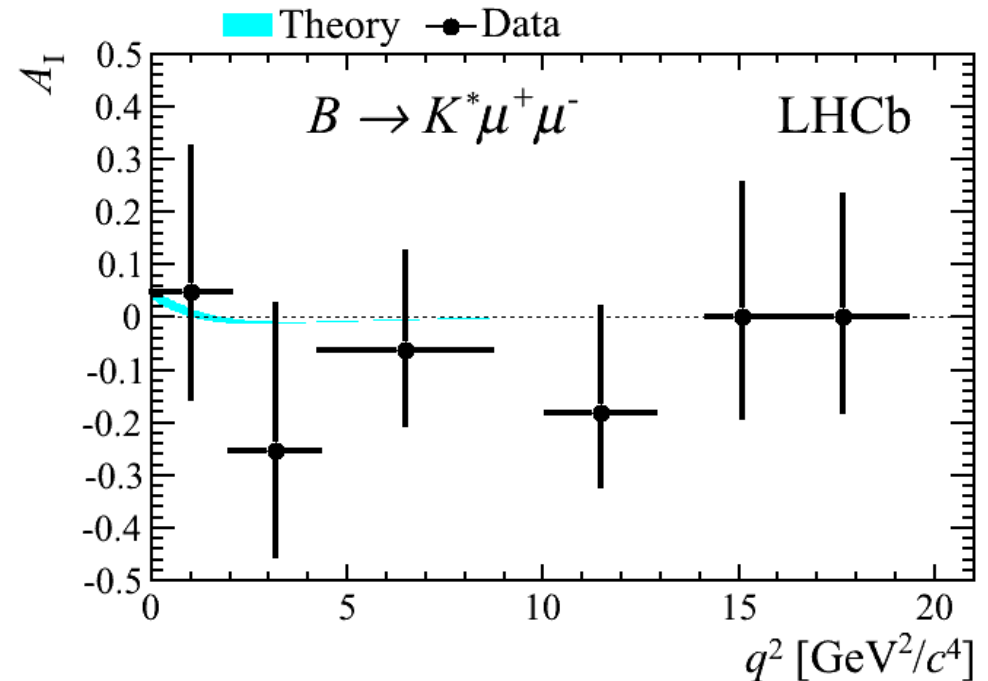

Consistent with zero & with SM prediction
 Consistent with previous measurements
 (BaBar, Belle, CDF)

Future prospects

Quark flavour physics: short and mid-term projects

- Good short-term prospects with existing experiments
 - LHCb & BES taking new data plus final analyses from completed experiments
 - NA62 and KOTO coming online to probe $K \rightarrow \pi\nu\nu$ decays
- In the second half of this decade will transition to next generation experiments → very exciting future!
 - Belle2 (start 2016/7) & LHCb upgrade (start 2019)
 - possibilities for τ -charm factories in Russia, Turkey, Italy
 - SuperB unfortunately cancelled, however
 - KOTO phase II, ORKA, possible extension of NA62

LHC upgrade and the all important trigger

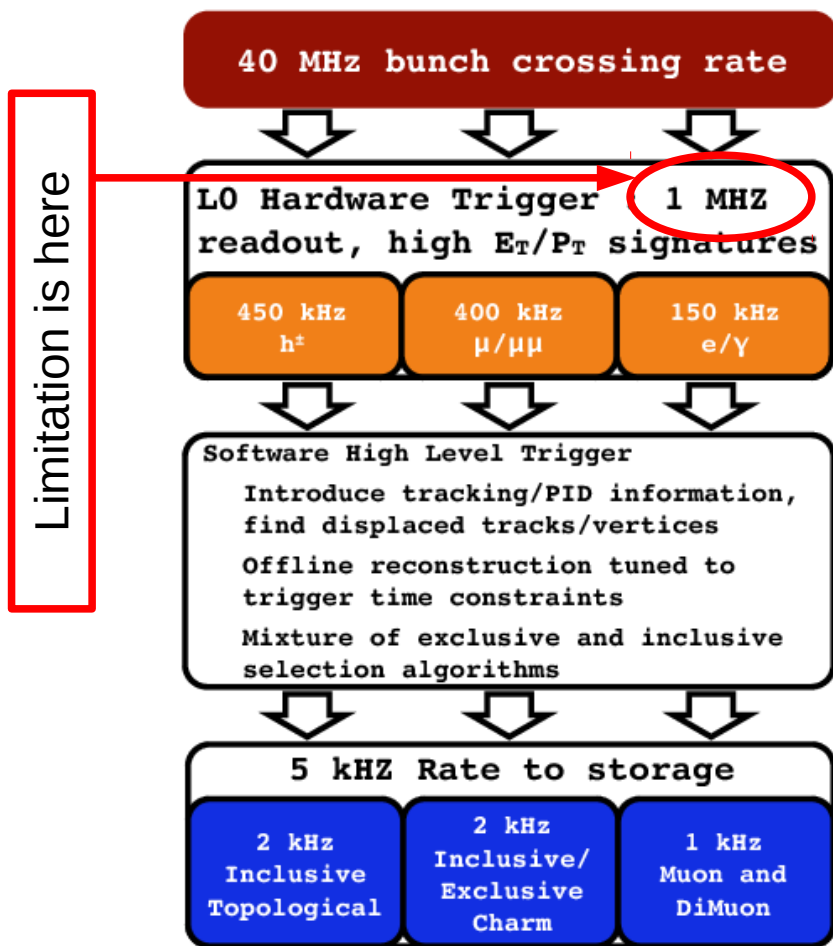

higher luminosity
 → need to cut harder at L0 to keep rate at 1 MHz
 → lower efficiency

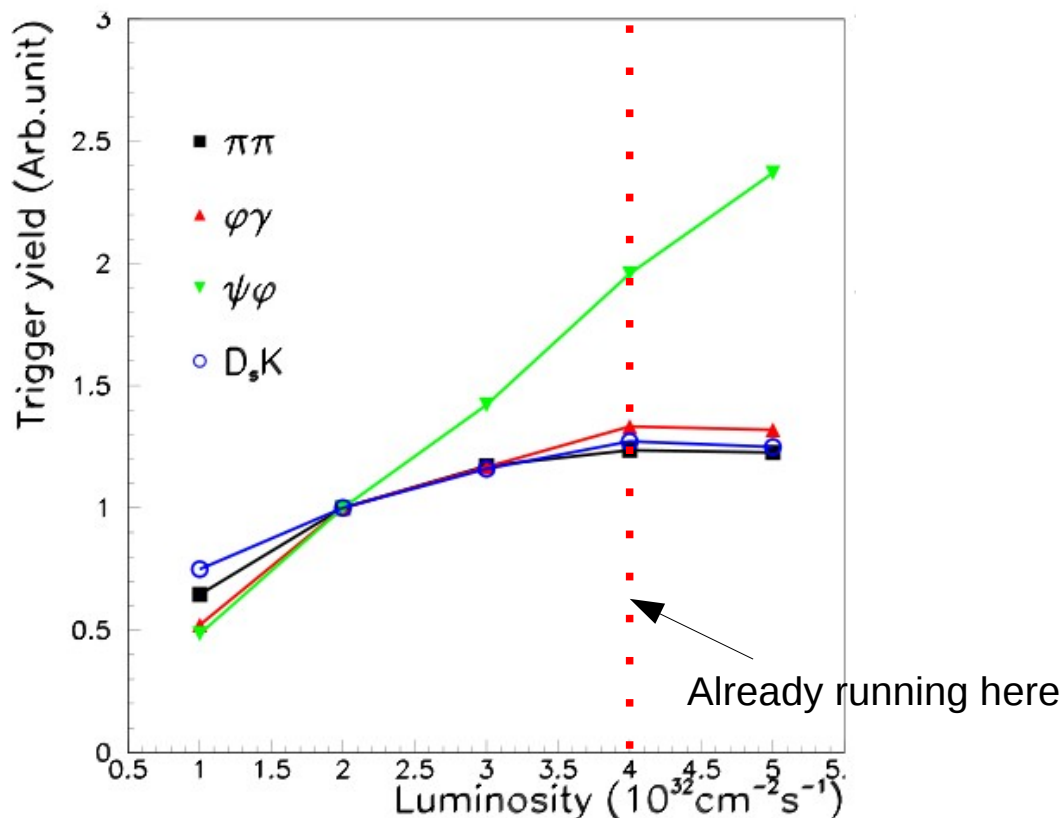

- readout detector at 40 MHz
- implement trigger fully in software → efficiency gains
- run at L_{inst} up to $2 \cdot 10^{33} / \text{cm}^2 / \text{s}$

LHCb detector upgrade

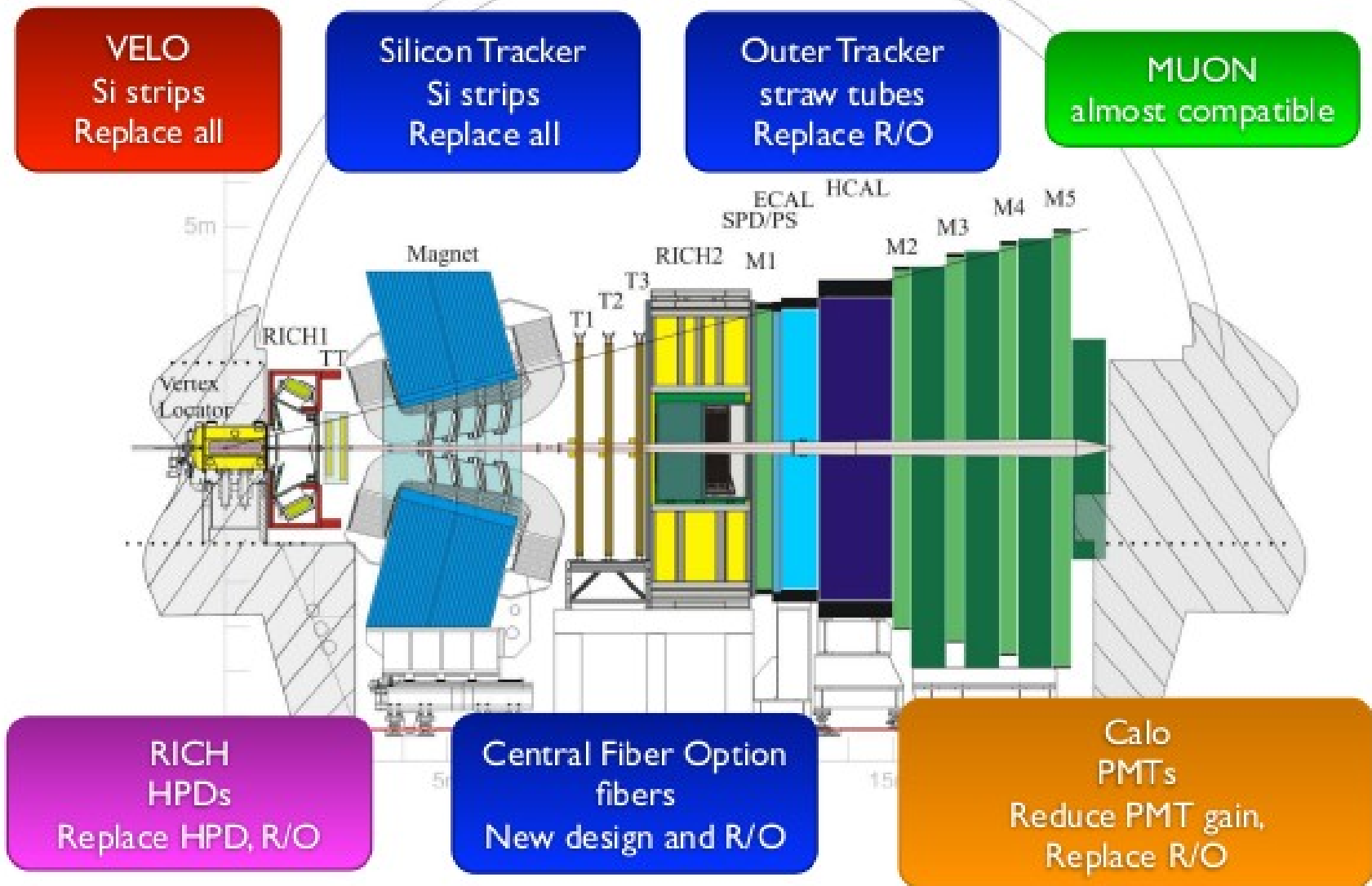

Several options still under study (e.g. strips/pixels for VELO)
Decisions to be made soon with TDRs available ~end 2013

LHCb upgrade timeline

- 2011
 - Letter of Intent: [CERN-LHCC-2011-001](#)
- 2012
 - Framework TDR: [CERN-LHCC-2012-007](#)
 - **Endorsed by LHCC and approved by CERN Research Board** ([minutes](#))
 - LHCb upgrade features prominently in draft European Strategy for Particle Physics
 - See also [arXiv:1208.3355](#) for physics discussion
- **2013**
 - Sub-detector TDRs ← **preparation of TDRs already started**
- 2014-17
 - Final R&D, production and construction
- 2018 (LS2)
 - Installation of upgraded LHCb detector (requires 18 months)

Summary

- Huge recent progress in quark-flavour physics
 - many important new results from BaBar, Belle, BES, CDF, D0, ...
 - and in particular, LHCb, which has definitively proved the concept of a forward spectrometer at a hadron collider
- Standard Model still survives
 - several “tensions” alleviated with improved measurements
 - further investigation still needed in many areas (a_{sl} , $B \rightarrow D^{(*)}TV$, etc.)
 - not a cause for depression! Now probing regions where “realistic” new physics effects might appear
- Exciting short- and mid-term prospects
 - next generation experiments in kaon, charm and B physics
 - LHCb upgrade confirmed as a core component of LHC exploitation

Back up

Range of CKM phenomena

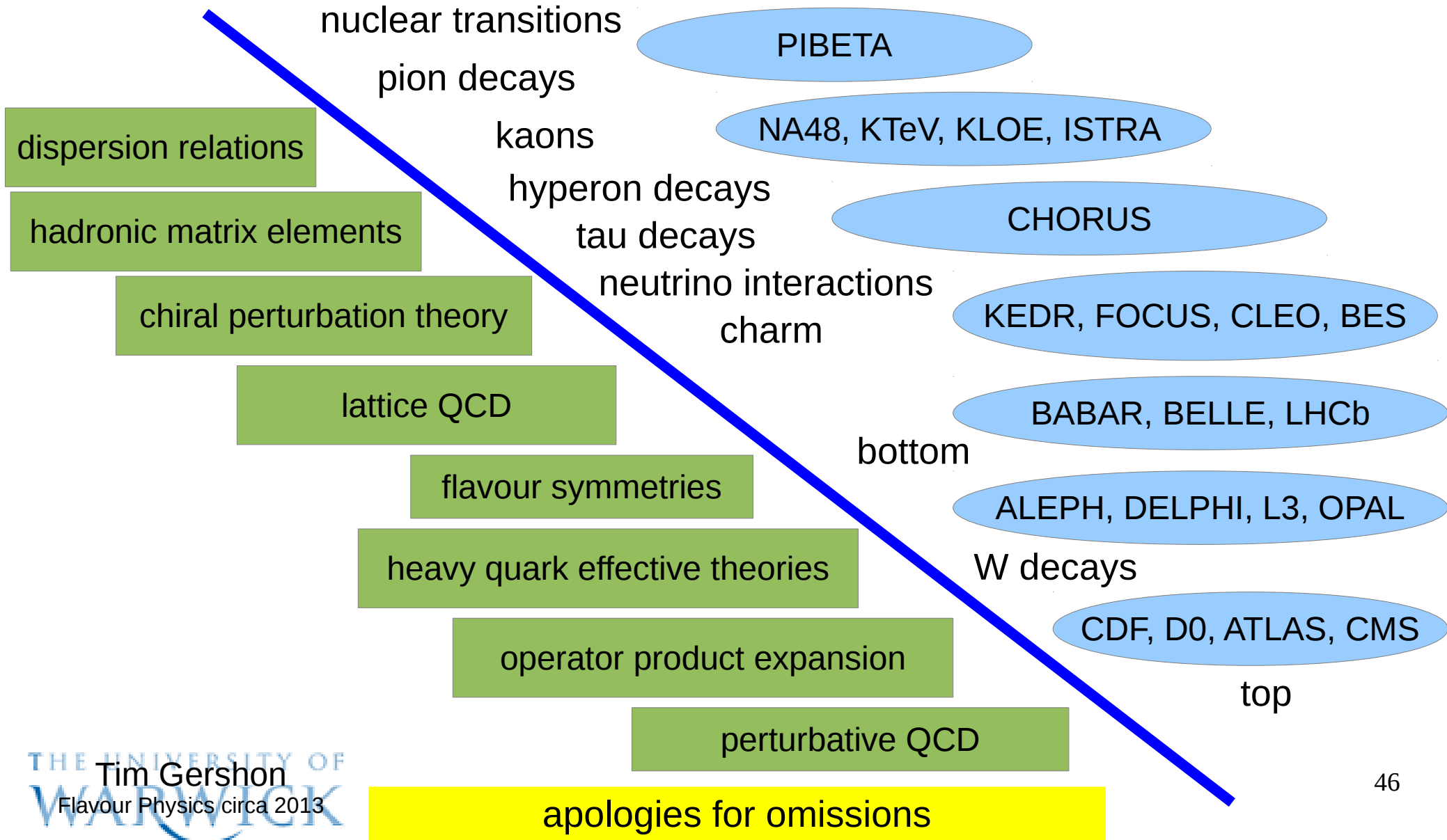

CP violation and the matter-antimatter asymmetry

- Two widely known facts
 - 1) CP violation is one of 3 “Sakharov conditions” necessary for the evolution of a baryon asymmetry in the Universe
 - 2) The Standard Model (CKM) CP violation is not sufficient to explain the observed asymmetry
- Therefore, there must be more sources of CP violation in nature ... but where?
 - extended quark sector, lepton sector (leptogenesis), supersymmetry, anomalous gauge couplings, extended Higgs sector, quark-gluon plasma, flavour-diagonal phases, ...
- Testing the consistency of the CKM mechanism provides the best chance to find new sources of CP violation today

Heavy flavour production @ ATLAS

“Measurement of the differential cross-sections of inclusive, prompt and non-prompt J/ψ production in proton-proton collisions at $\sqrt{s} = 7$ TeV”
 Nucl. Phys. B 850 (2011) 387

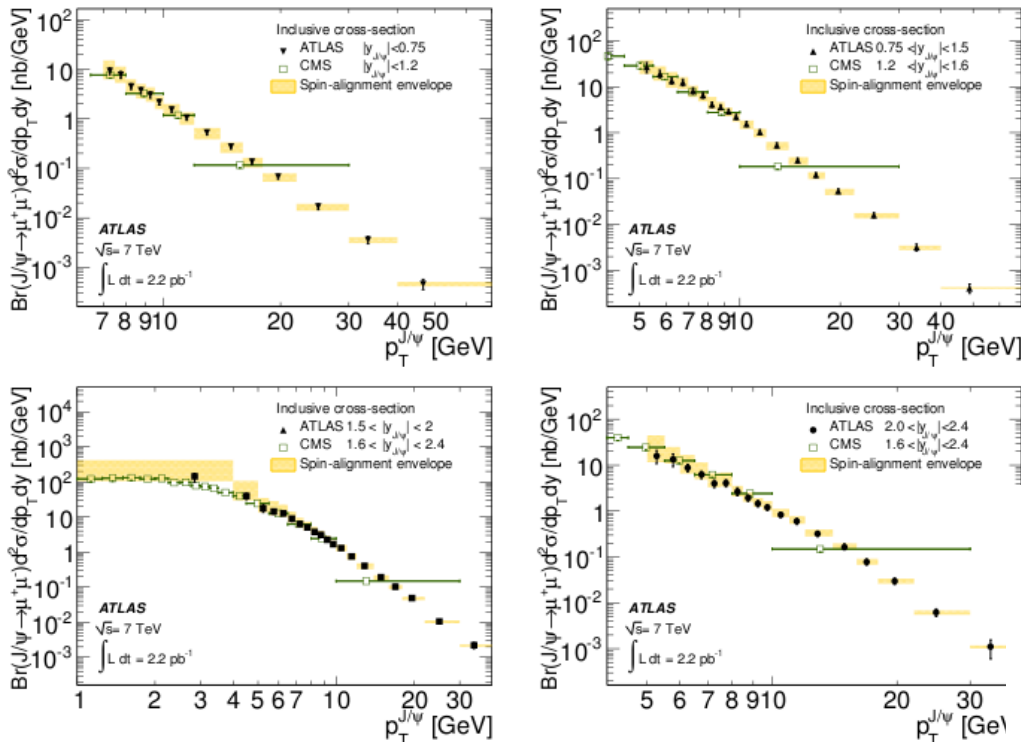

“Measurement of the b-hadron production cross section using decays to $D^{*+} \mu^- X$ final states in pp collisions at $\sqrt{s} = 7$ TeV with the ATLAS detector”
 Nucl. Phys. B 864 (2012) 341

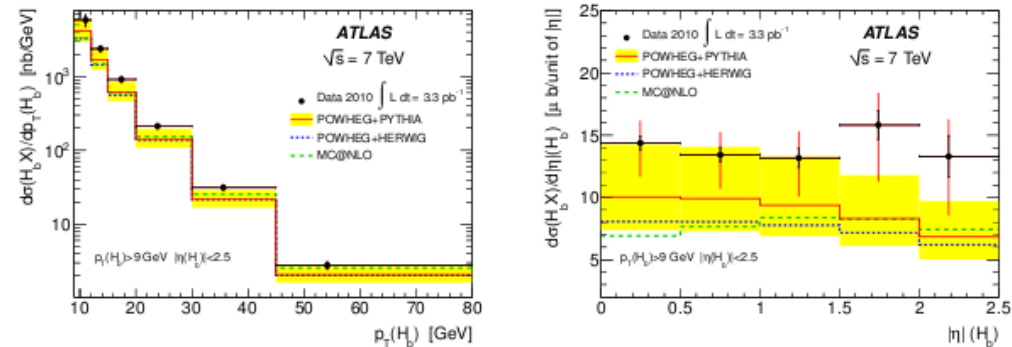

(a)

(b)

Heavy flavour production @ CMS

“J/ψ and ψ(2S) production in pp collisions
at $\sqrt{s} = 7$ TeV”

J. High Energy Phys. 02 (2012) 011

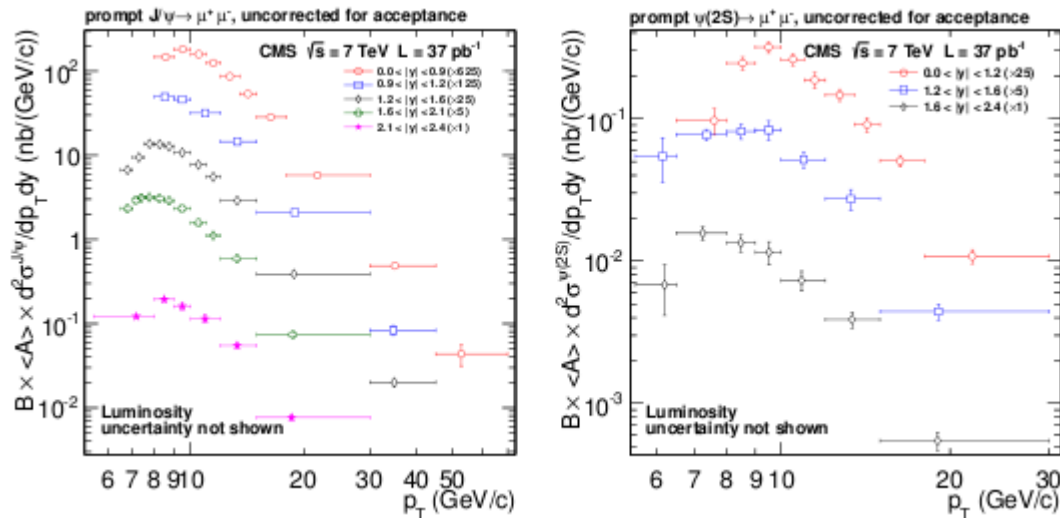

“Measurement of the cross section for
production of b b-bar X, decaying to
muons in pp collisions at $\sqrt{s}=7$ TeV”

J. High Energy Phys. 06 (2012) 110

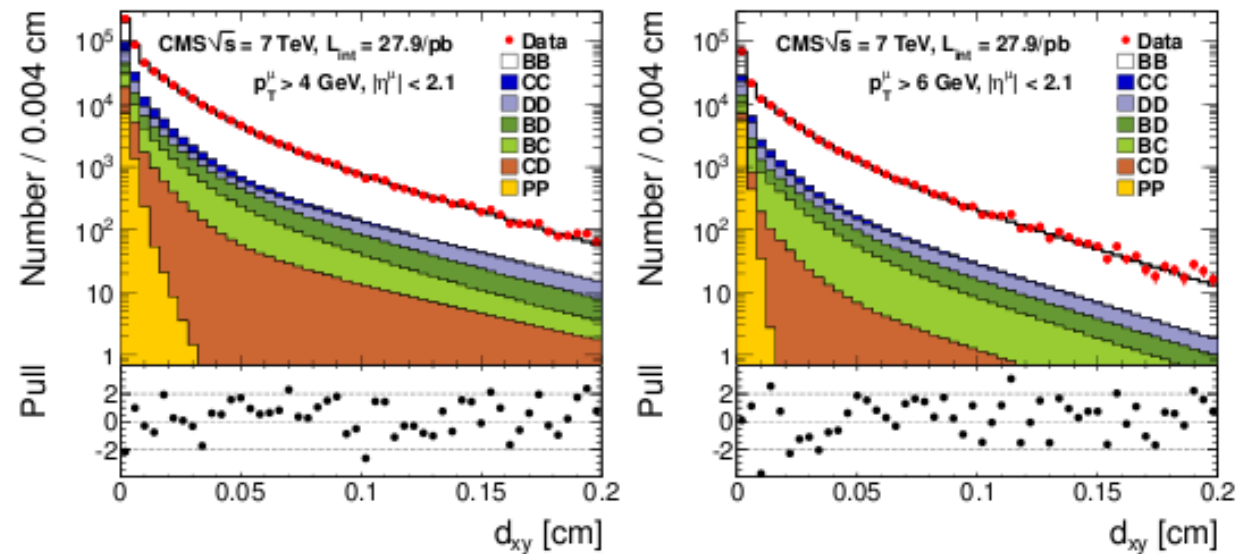

Heavy flavour production @ LHCb

“Prompt charm production in pp collisions at $\sqrt{s} = 7$ TeV”
LHCb-PAPER-2012-041

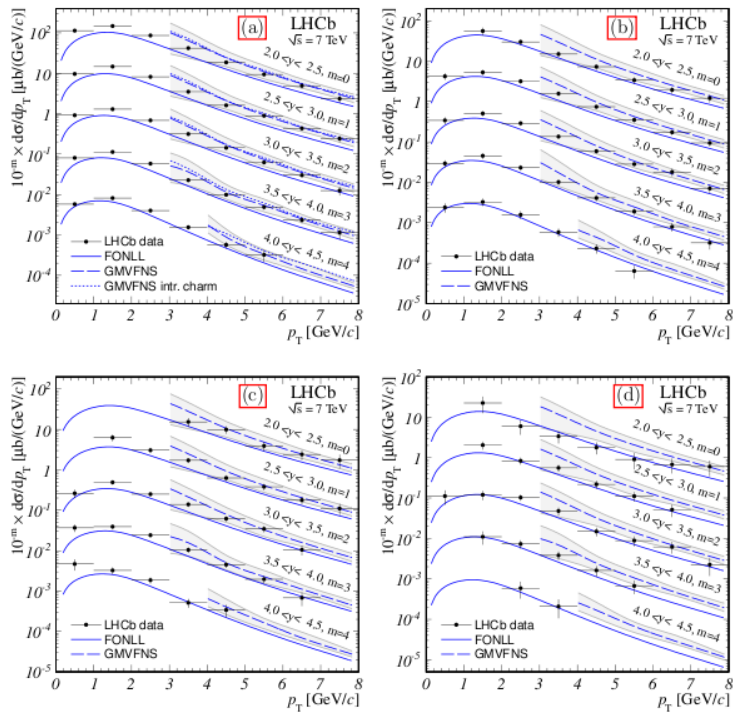

(a) D^0 , (b) D^+ , (c) D^{*+} , (d) D_s^+

“Measurement of J/ψ production in pp collisions at $\sqrt{s} = 7$ TeV”
Eur. Phys. J. C 71 (2011) 1645

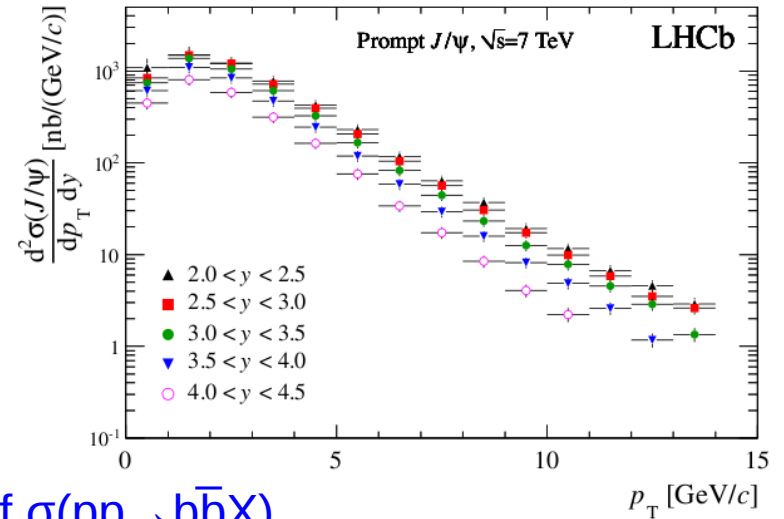

“Measurement of $\sigma(pp \rightarrow b\bar{b}X)$ at $\sqrt{s} = 7$ TeV in the forward region”
Physics Letters B 694 (2010) 209

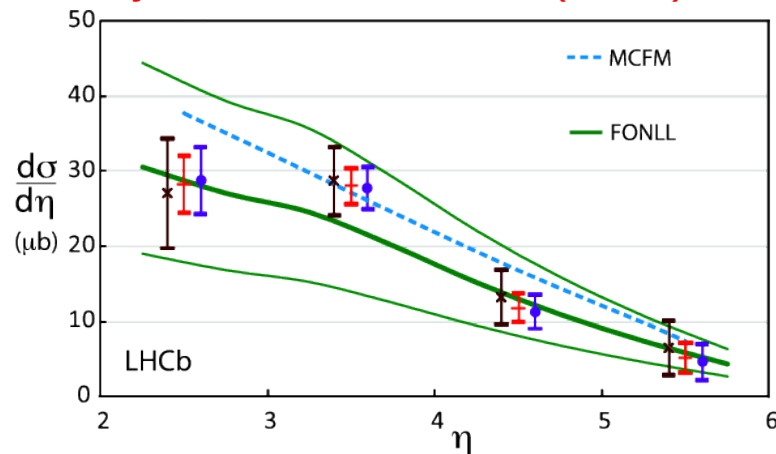

The smoking gun exotic hadron: A charged charmonium-like state

$$B^0 \rightarrow Z(4430)^- K^+, Z(4430)^- \rightarrow \psi' \pi^-$$

Belle PRL 100 (2008) 142001

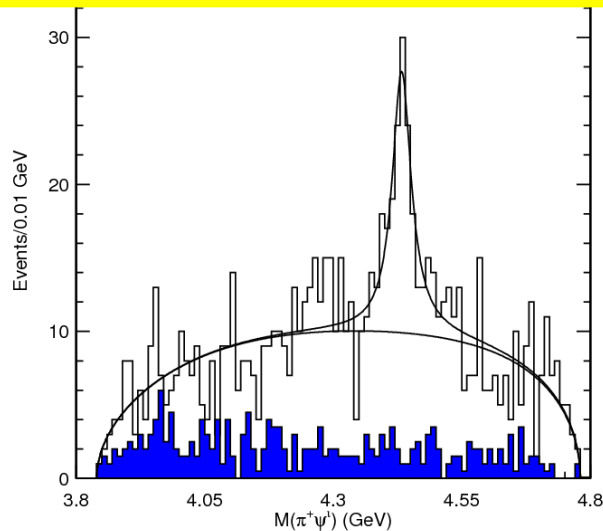

Clear peak

Still there in more detailed analysis

PRD 80 (2009) 031104

BABAR PRD 79 (2009) 112001

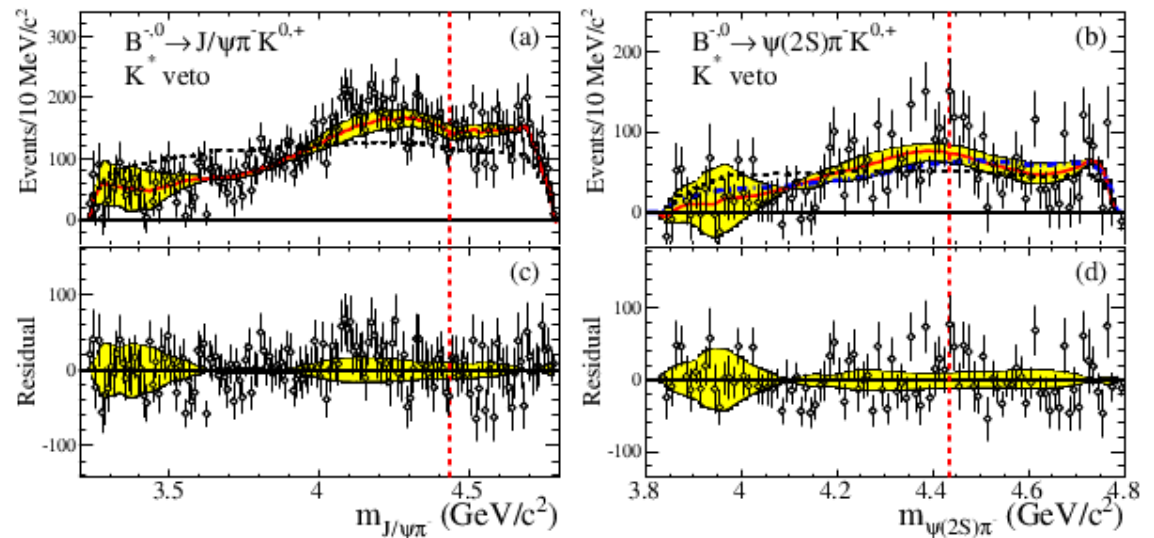

Data consistent with $K\pi$ reflections

Slight peak but no evidence for new state

But also consistent with Belle

Need more experimental input
(CDF, D0, ATLAS, CMS or LHCb)

$$\Phi_s = -2\beta_s (B_s \rightarrow J/\psi\phi)$$

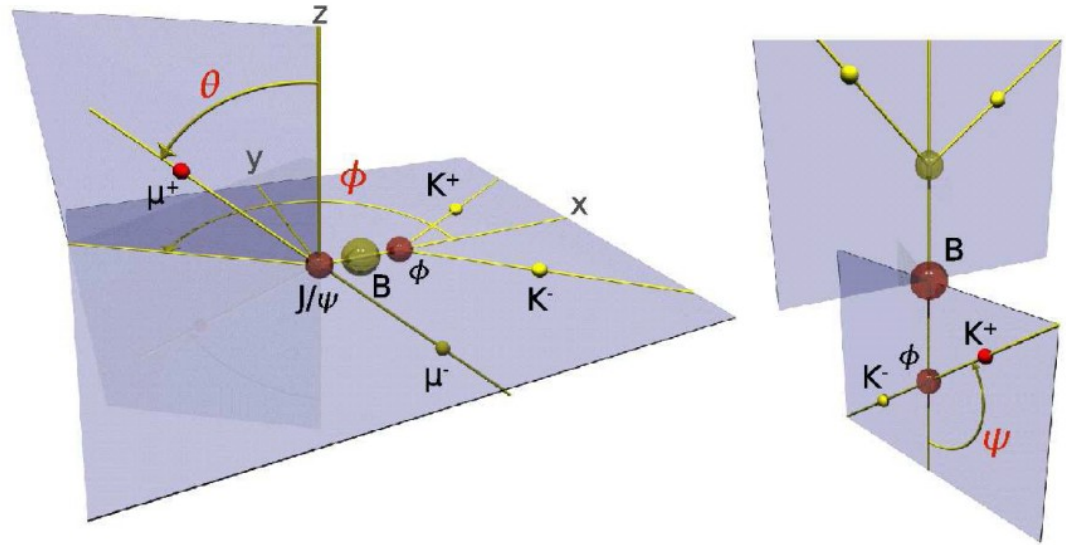

- VV final state

three helicity amplitudes

→ mixture of CP-even and CP-odd

disentangled using angular & time-dependent distributions

→ additional sensitivity

many correlated variables

→ complicated analysis

- LHCb also uses $B_s \rightarrow J/\psi f_0$ ($f_0 \rightarrow \pi^+\pi^-$)

- CP eigenstate; simpler analysis

- fewer events; requires input from $J/\psi\phi$ analysis ($\Gamma_s, \Delta\Gamma_s$)

B → DK decays
give theoretically clean
way to measure
CKM phase γ

B → DK decays

“GLW” and “ADS” methods

LHCb
Phys. Lett. B 712 (2012) 203

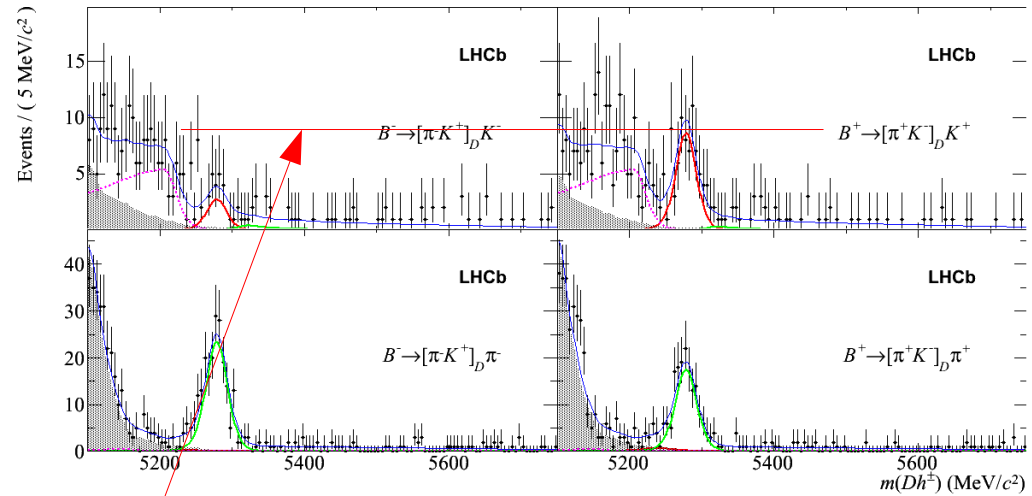
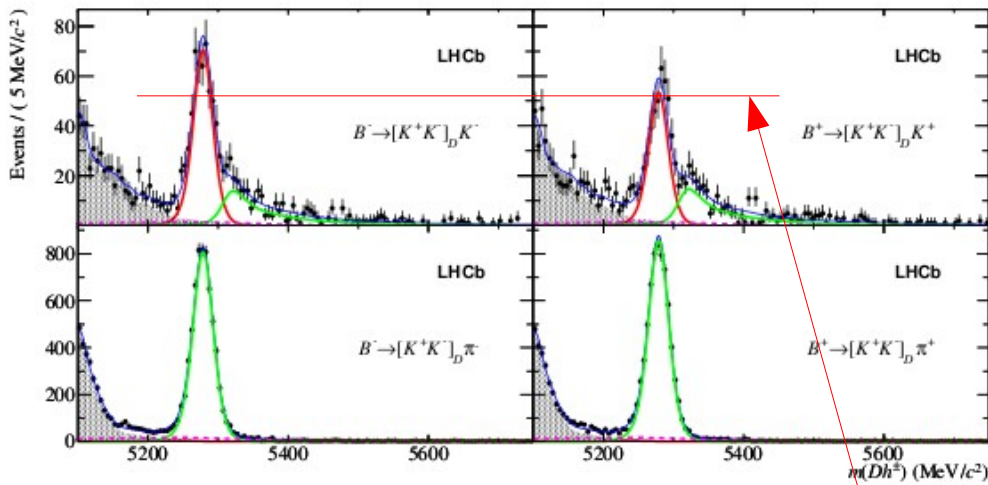

$D_{CP} K A_{CP+}$ **HFAG**
Moriond 2012
PRELIMINARY

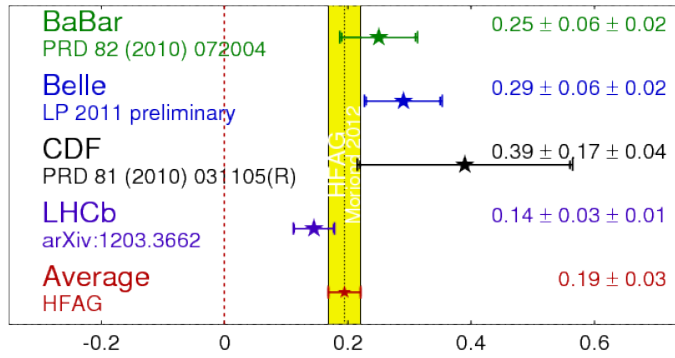

$D_K \pi K R_{ADS}$ **HFAG**
Moriond 2012
PRELIMINARY

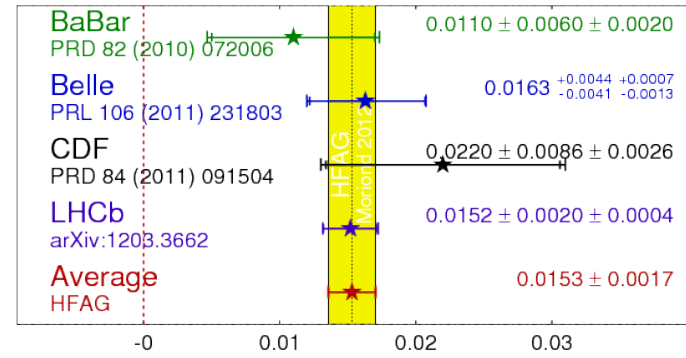

Observation of CP violation in B → DK decays

γ from $B^+ \rightarrow DK^+, D \rightarrow K_S^0 h^+ h^-$

LHCb (1/fb)
Phys. Lett. B 718 (2012) 43

- Results from “GGSZ” mode very important to break ambiguities in determination of γ
- Model-independent approach using $D \rightarrow K_S^0 \pi^+ \pi^-$ and (world first) $D \rightarrow K_S^0 K^+ K^-$

$K_S^0 \pi^+ \pi^-$ in two
 K_S^0 categories

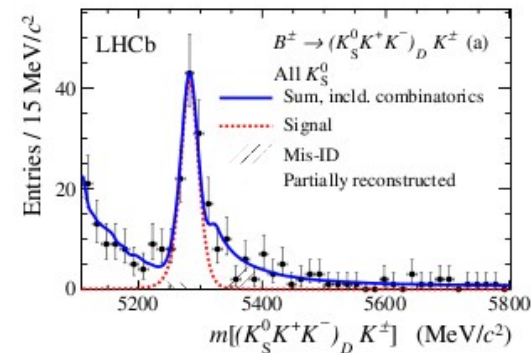
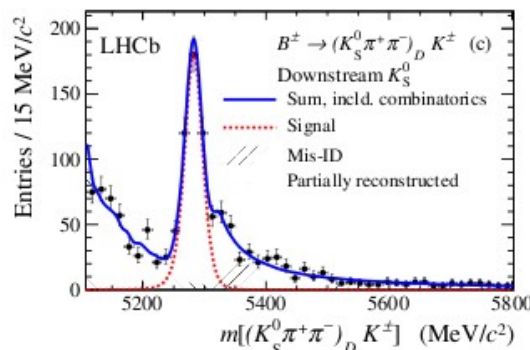
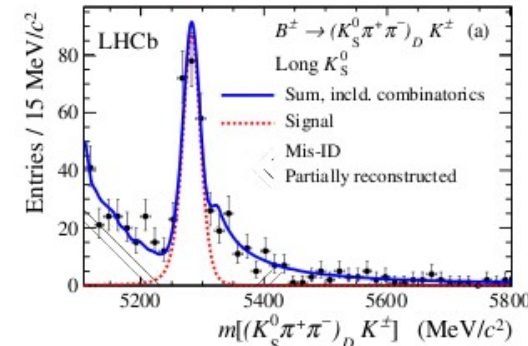

$K_S^0 K^+ K^-$
(all combined)

γ from $B^+ \rightarrow DK^+$, $D \rightarrow K_S^0 h^+ h^-$

LHCb (1/fb)
Phys. Lett. B 718 (2012) 43

Reconstruct Dalitz plot distributions ...

... bin them ...

(in complicated but ~optimal way)

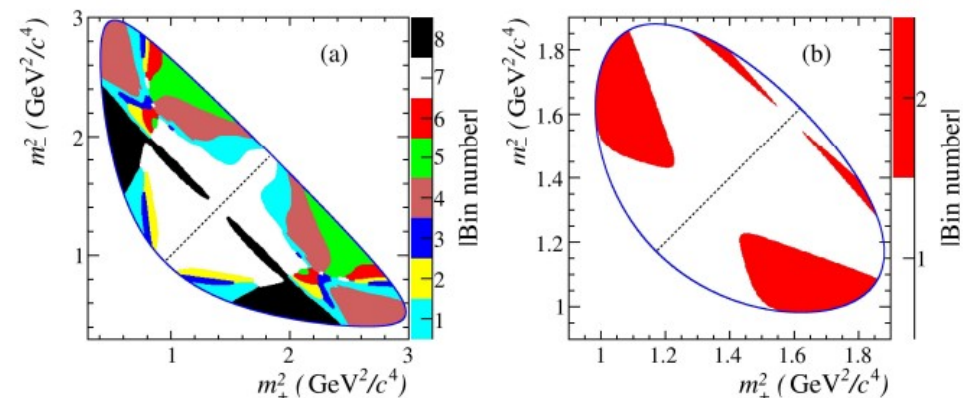
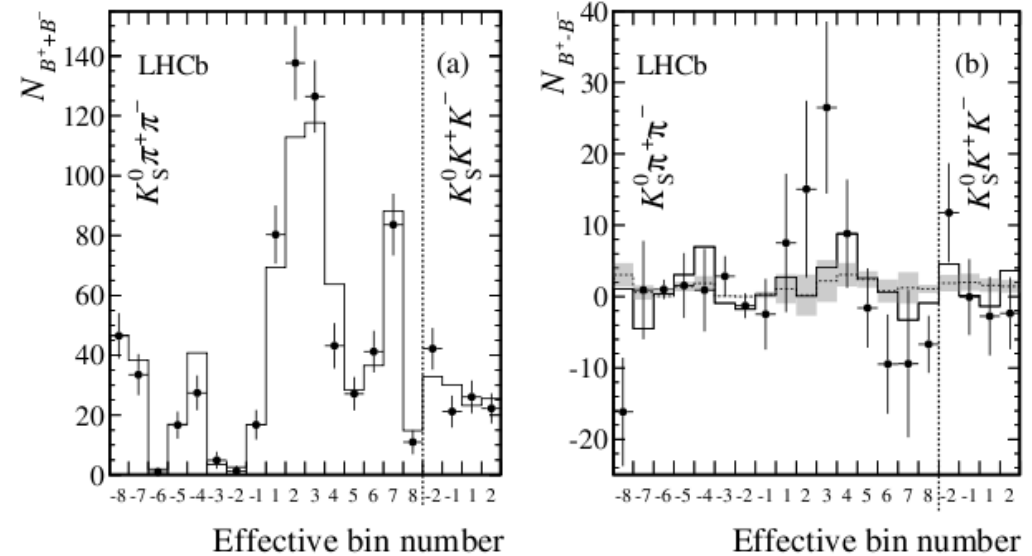
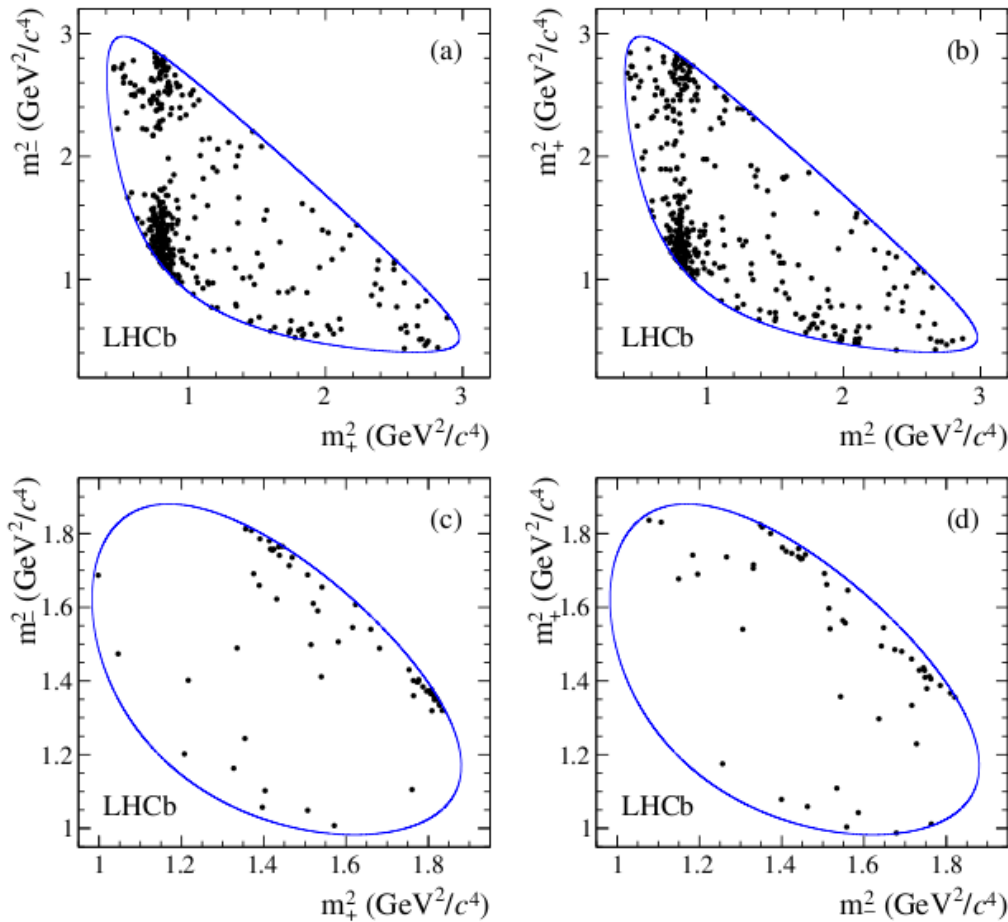

γ from $B^+ \rightarrow DK^+$, $D \rightarrow K_S^0 h^+ h^-$

LHCb (1/fb)
Phys. Lett. B 718 (2012) 43

Reconstruct Dalitz plot distributions ...

... bin them ...

(in complicated but ~optimal way)

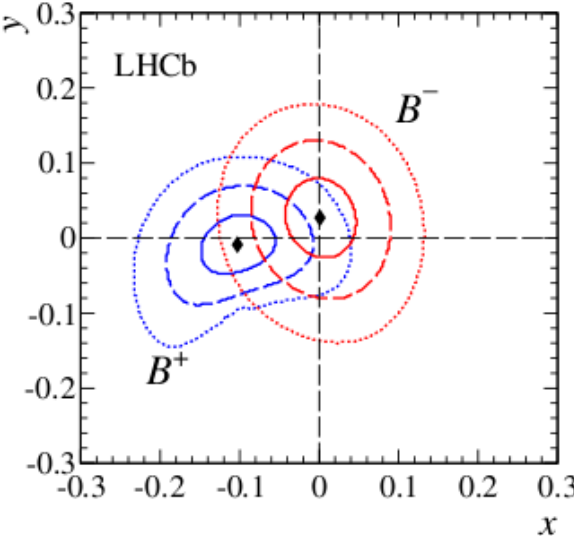
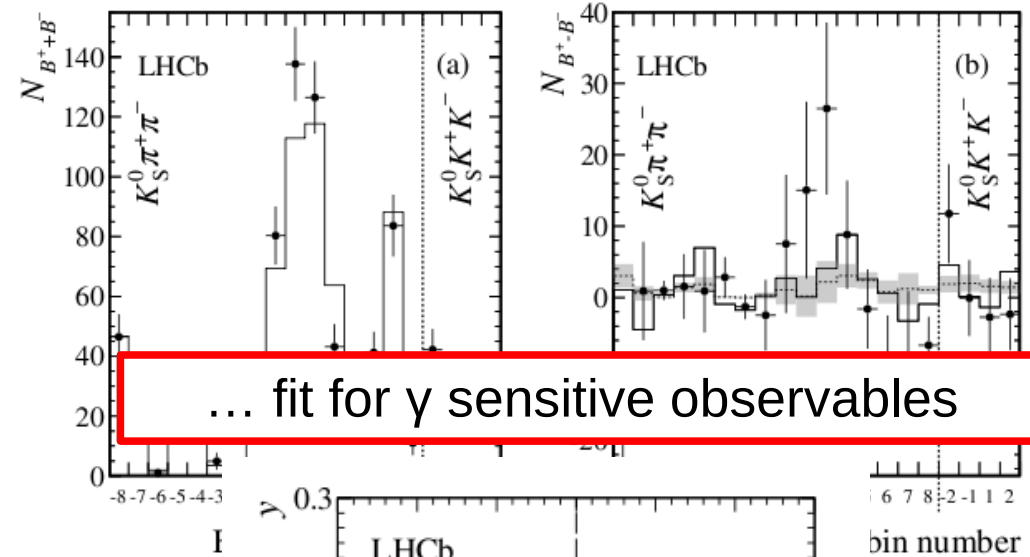
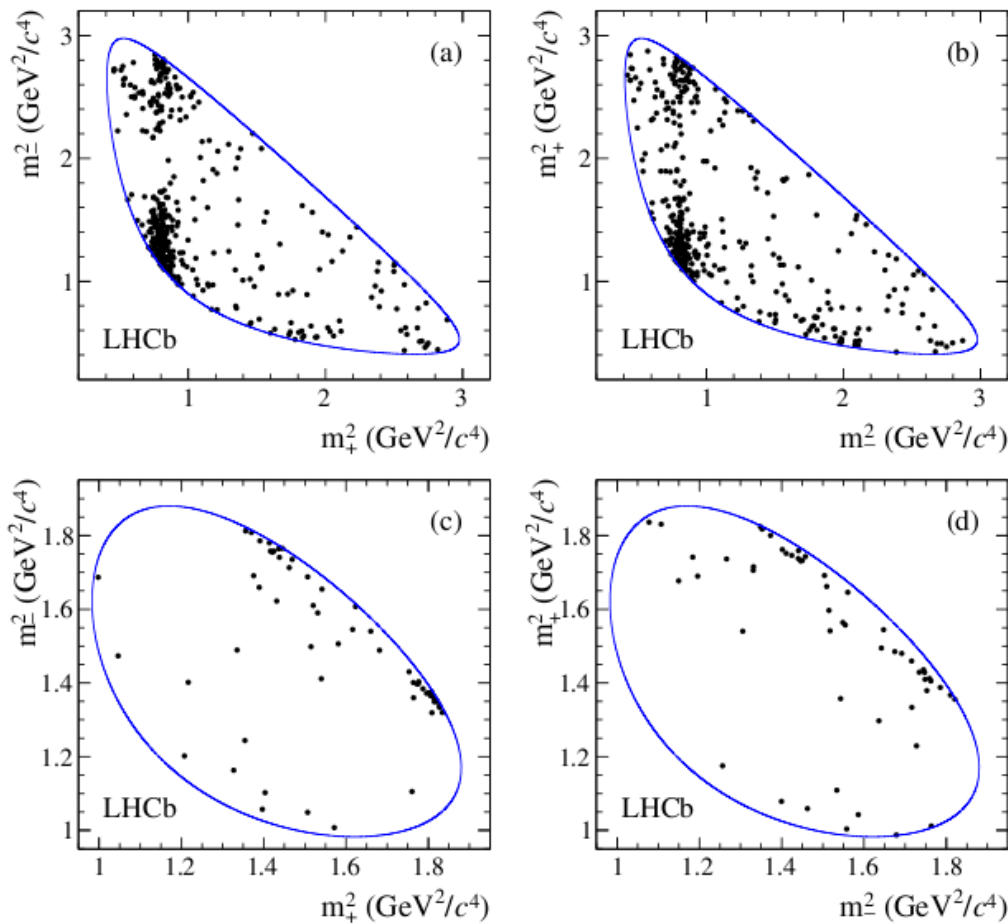

$|V_{ub}|$ from {in,ex}clusive semileptonic decays

PBFLB based on
 BaBar PRD 83 (2011) 052011 &
 PRD 83 (2011) 032007
 Belle PRD 83 (2011) 071101(R)

Some tension between exclusive and inclusive results. PBFLB concludes:

$$|V_{ub}|_{\text{excl}} = [3.23 (1 \pm 0.05_{\text{exp}} \pm 0.08_{\text{th}})] \times 10^{-3}$$

$$|V_{ub}|_{\text{incl}} = [4.42 (1 \pm 0.045_{\text{exp}} \pm 0.034_{\text{th}})] \times 10^{-3}$$

This average has a probability of $P(\chi^2) = 0.003$. Thus we scale the error by $\sqrt{\chi^2} = 3.0$ and arrive at

$$|V_{ub}| = [3.95 (1 \pm 0.096_{\text{exp}} \pm 0.099_{\text{th}})] \times 10^{-3}$$

Similar tension also for $|V_{cb}|$

Better understanding needed to reduce uncertainty

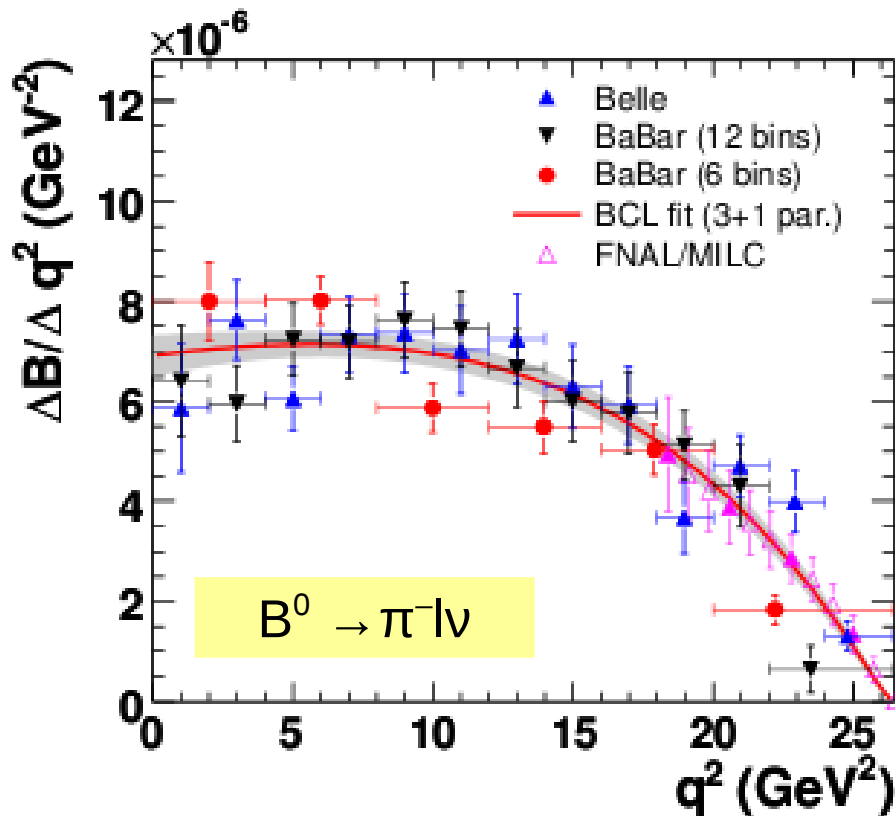

Upgrade – expected sensitivities

Type	Observable	Current precision	LHCb 2018	Upgrade (50 fb ⁻¹)	Theory uncertainty
B_s^0 mixing	$2\beta_s (B_s^0 \rightarrow J/\psi \phi)$	0.10 [9]	0.025	0.008	~ 0.003
	$2\beta_s (B_s^0 \rightarrow J/\psi f_0(980))$	0.17 [10]	0.045	0.014	~ 0.01
	$A_{\text{fs}}(B_s^0)$	6.4×10^{-3} [18]	0.6×10^{-3}	0.2×10^{-3}	0.03×10^{-3}
Gluonic penguin	$2\beta_s^{\text{eff}}(B_s^0 \rightarrow \phi\phi)$	–	0.17	0.03	0.02
	$2\beta_s^{\text{eff}}(B_s^0 \rightarrow K^{*0}\bar{K}^{*0})$	–	0.13	0.02	< 0.02
	$2\beta_s^{\text{eff}}(B^0 \rightarrow \phi K_S^0)$	0.17 [18]	0.30	0.05	0.02
Right-handed currents	$2\beta_s^{\text{eff}}(B_s^0 \rightarrow \phi\gamma)$	–	0.09	0.02	< 0.01
	$\tau^{\text{eff}}(B_s^0 \rightarrow \phi\gamma)/\tau_{B_s^0}$	–	5 %	1 %	0.2 %
Electroweak penguin	$S_3(B^0 \rightarrow K^{*0}\mu^+\mu^-; 1 < q^2 < 6 \text{ GeV}^2/c^4)$	0.08 [14]	0.025	0.008	0.02
	$s_0 A_{\text{FB}}(B^0 \rightarrow K^{*0}\mu^+\mu^-)$	25 % [14]	6 %	2 %	7 %
	$A_1(K\mu^+\mu^-; 1 < q^2 < 6 \text{ GeV}^2/c^4)$	0.25 [15]	0.08	0.025	~ 0.02
	$\mathcal{B}(B^+ \rightarrow \pi^+\mu^+\mu^-)/\mathcal{B}(B^+ \rightarrow K^+\mu^+\mu^-)$	25 % [16]	8 %	2.5 %	$\sim 10\%$
Higgs penguin	$\mathcal{B}(B_s^0 \rightarrow \mu^+\mu^-)$	1.5×10^{-9} [2]	0.5×10^{-9}	0.15×10^{-9}	0.3×10^{-9}
	$\mathcal{B}(B^0 \rightarrow \mu^+\mu^-)/\mathcal{B}(B_s^0 \rightarrow \mu^+\mu^-)$	–	$\sim 100\%$	$\sim 35\%$	$\sim 5\%$
Unitarity triangle angles	$\gamma (B \rightarrow D^{(*)}K^{(*)})$	$\sim 10\text{--}12^\circ$ [19, 20]	4°	0.9°	negligible
	$\gamma (B_s^0 \rightarrow D_s K)$	–	11°	2.0°	negligible
	$\beta (B^0 \rightarrow J/\psi K_S^0)$	0.8° [18]	0.6°	0.2°	negligible
Charm	A_Γ	2.3×10^{-3} [18]	0.40×10^{-3}	0.07×10^{-3}	–
CP violation	ΔA_{CP}	2.1×10^{-3} [5]	0.65×10^{-3}	0.12×10^{-3}	–

Table 1: Statistical sensitivities of the LHCb upgrade to key observables. For each observable the current sensitivity is compared to that which will be achieved by LHCb before the upgrade, and that which will be achieved with 50 fb⁻¹ by the upgraded experiment. Systematic uncertainties are expected to be non-negligible for the most precisely measured quantities.

- sample sizes in most exclusive B and D final states far larger than those collected elsewhere
- no serious competition in study of B_s decays and CP violation

KEKB to SuperKEKB



Colliding bunches

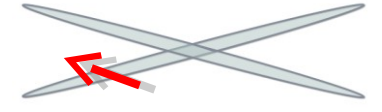

New superconducting / permanent final focusing quads near the IP

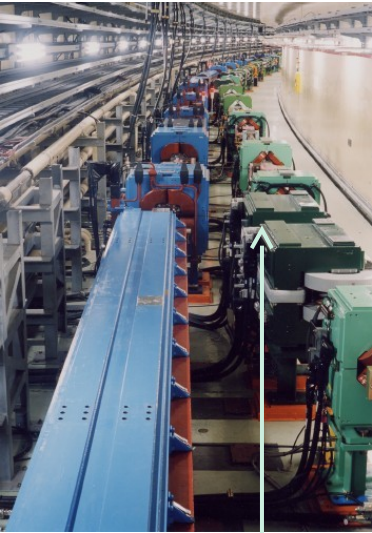
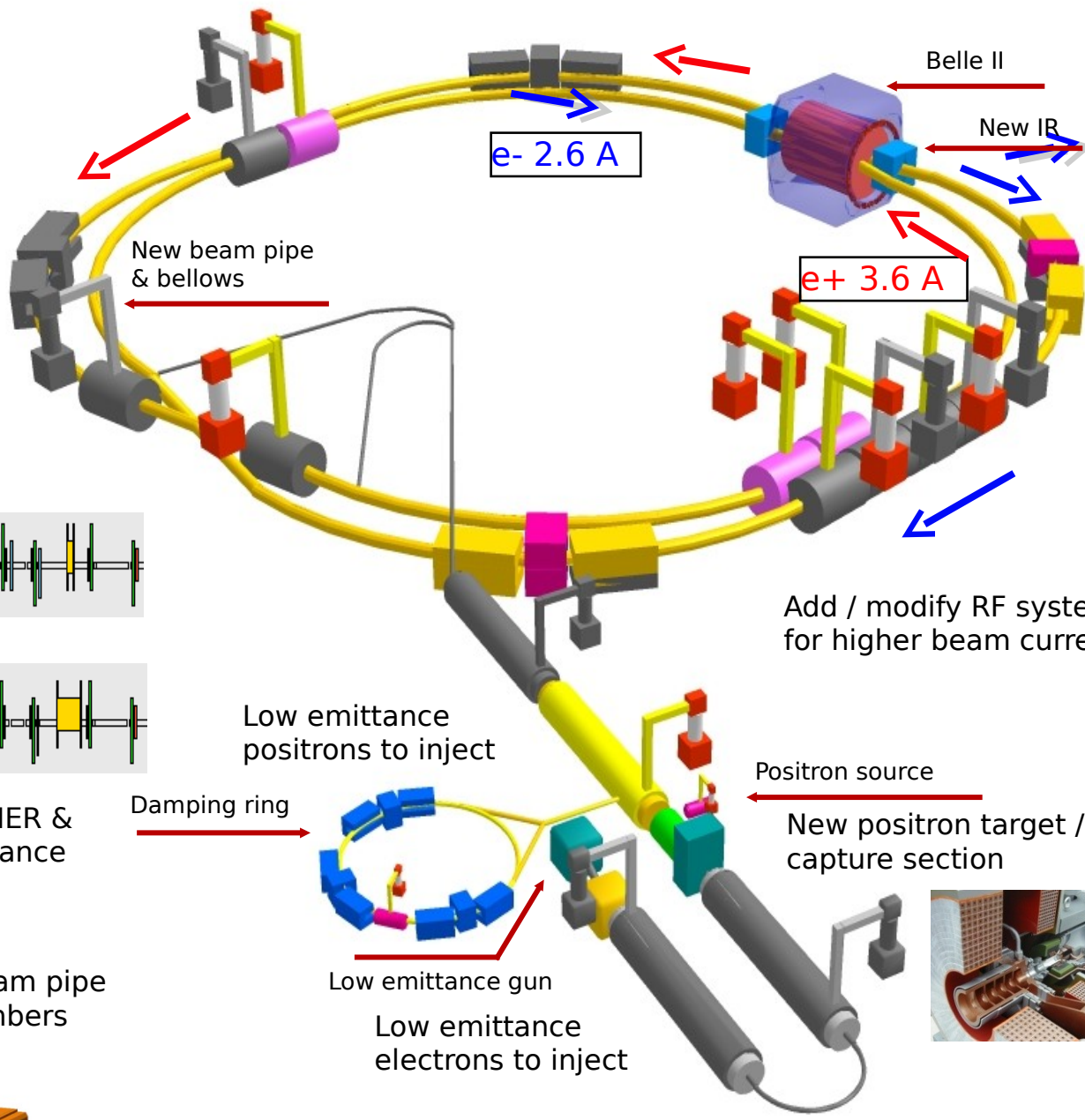
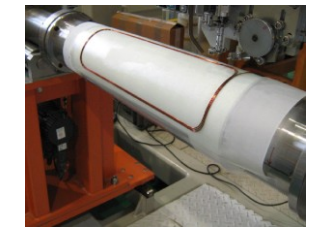

Replace short dipoles with longer ones (LER)

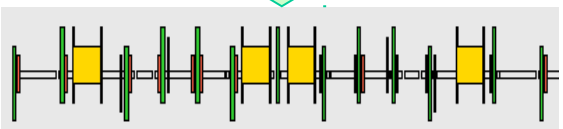
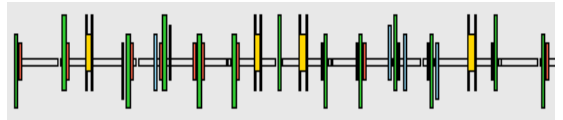

Redesign the lattices of HER & LER to squeeze the emittance

TiN-coated beam pipe with antechambers

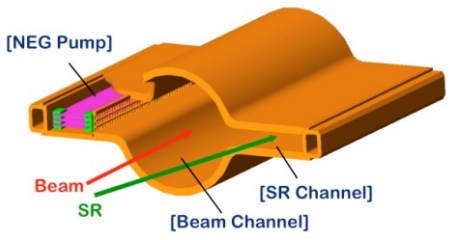

To obtain x40 higher luminosity

Belle II Detector

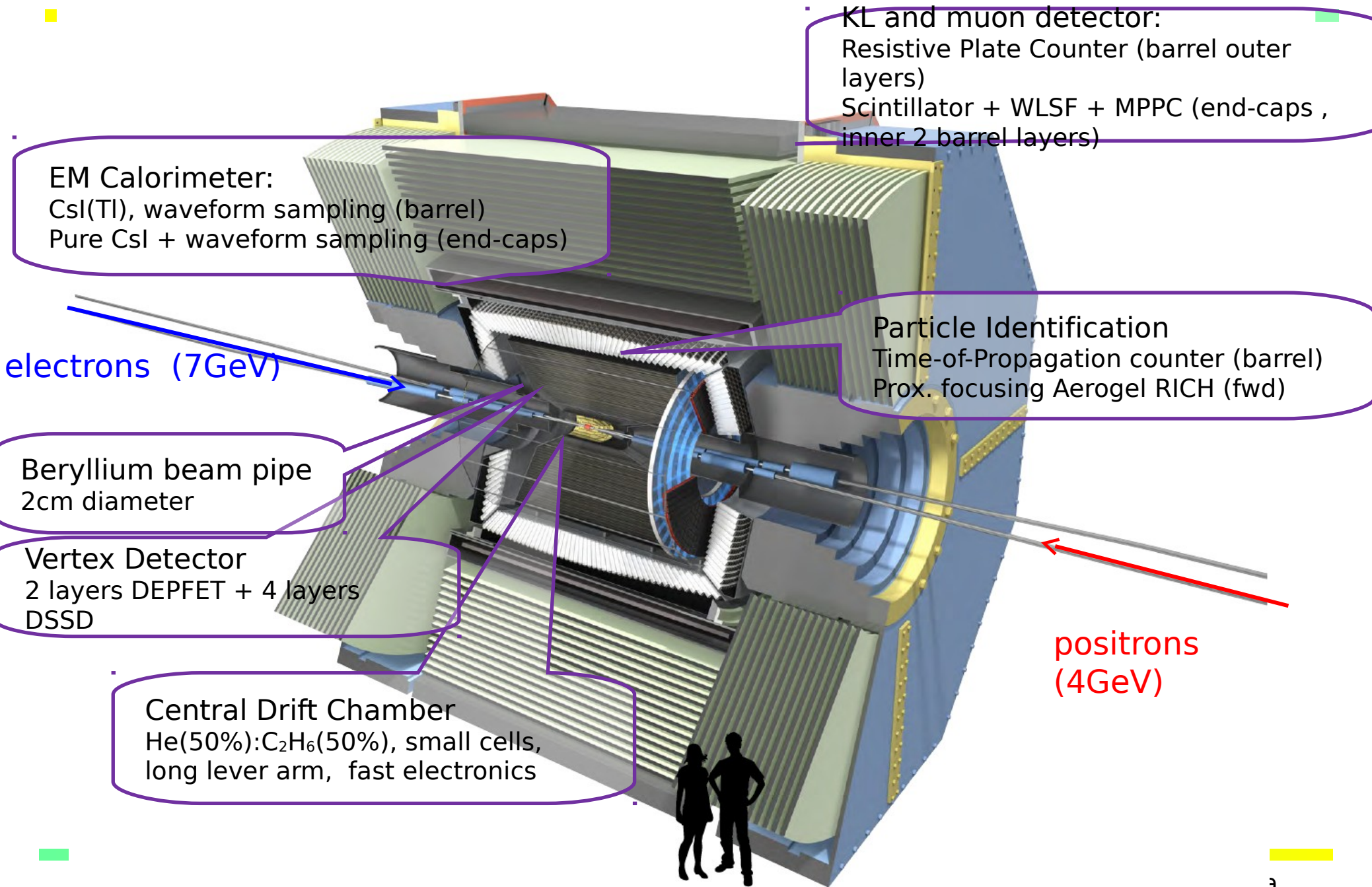

EM Calorimeter:
CsI(Tl), waveform sampling (barrel)
Pure CsI + waveform sampling (end-caps)

KL and muon detector:
Resistive Plate Counter (barrel outer layers)
Scintillator + WLSF + MPPC (end-caps, inner 2 barrel layers)

electrons (7GeV)

Particle Identification
Time-of-Propagation counter (barrel)
Prox. focusing Aerogel RICH (fwd)

Beryllium beam pipe
2cm diameter

Vertex Detector
2 layers DEPFET + 4 layers DSSD

positrons (4GeV)

Central Drift Chamber
He(50%):C₂H₆(50%), small cells,
long lever arm, fast electronics

Belle II Detector (in comparison with Belle)

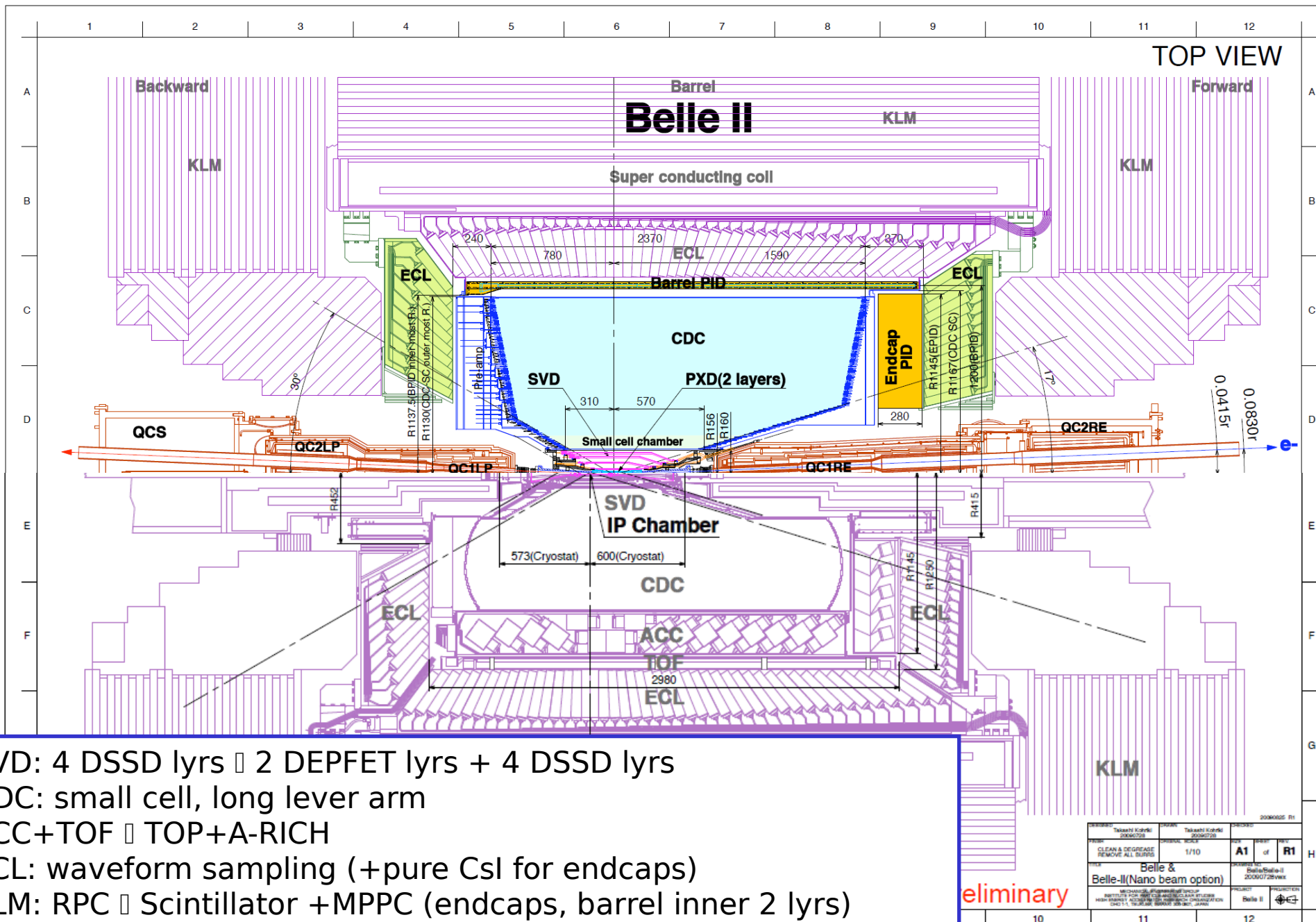

Schedule

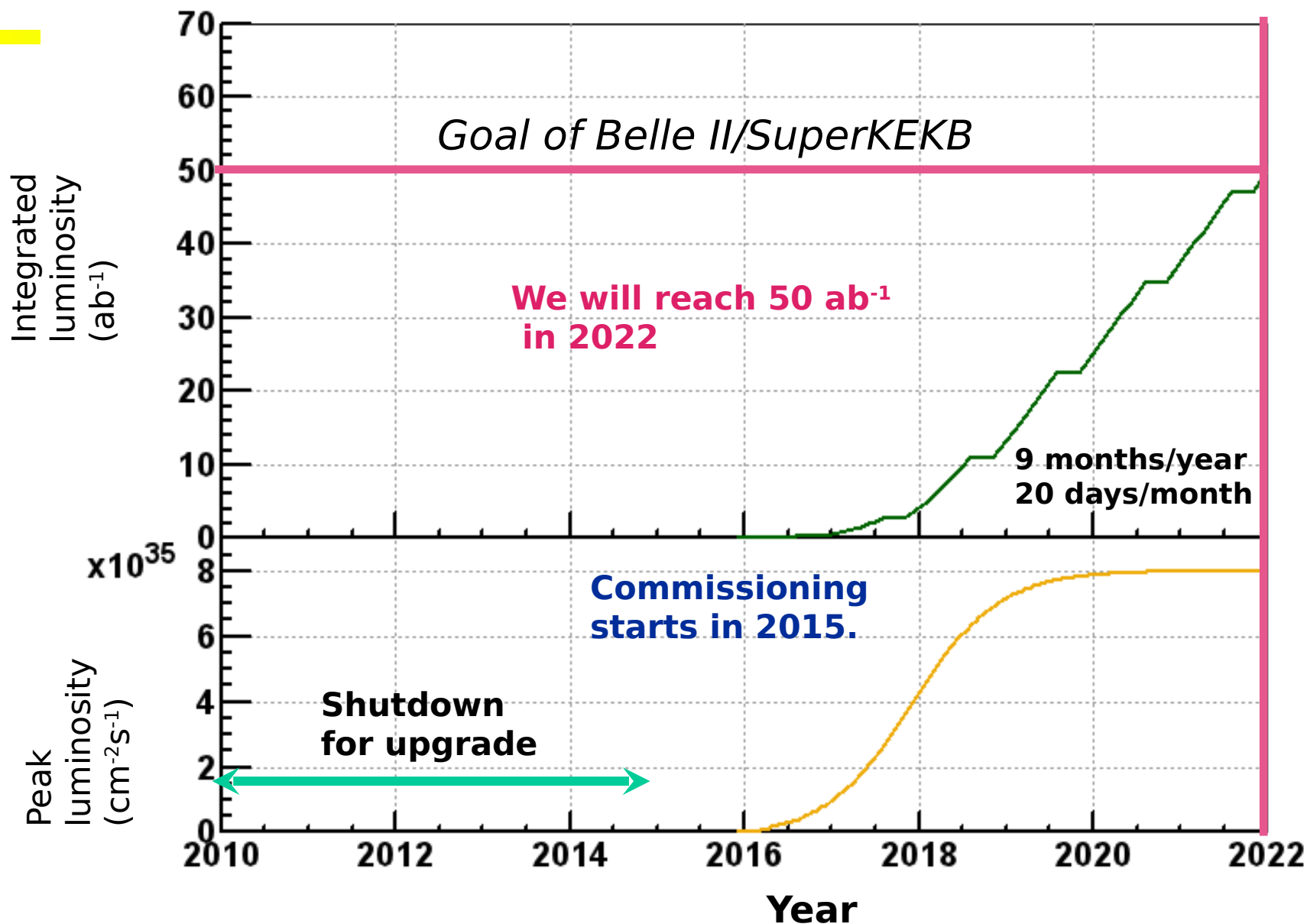

The schedule is likely to shift by a few months because of a new construction/commissioning strategy for the final quads.

The need for more precision

- “Imagine if Fitch and Cronin had stopped at the 1% level, how much physics would have been missed”

– A.Soni

- “A special search at Dubna was carried out by Okonov and his group. They did not find a single $K_L^0 \rightarrow \pi^+\pi^-$ event among **600 decays** into charged particles (Anikira et al., JETP 1962). At that stage the search was terminated by the administration of the lab. **The group was unlucky.**”

– L.Okun

(remember: $B(K_L^0 \rightarrow \pi^+\pi^-) \sim 2 \cdot 10^{-3}$)