

23rd ATF Users' Meeting

Diamond Detector with Adjustable Aperture

PI: Valeriy Konovalov, *Applied Diamond, Inc*

Collaborator: Toby Miller, *BNL*

Funding: DOE SBIR 2020 Phase-I, DE-SC0020498

Description

- **Goals**

- Measurement of CW beam core and halo profiles by fast scanning through the beam
- Measurement of beam temporal structures with ns resolution
- High radiation stability
- Ability to operate at high temperatures in the beam core without cooling

- **Design**

- Diamond multi-pixel strip sensor with B-doped electrical contacts
- High speed actuator (up to 1 m/c) and high precision sensor positioning ($\sim 5\mu\text{m}$)
- Sensor insertion time into the beam core $< 200\text{ms}$

- **Testing Schedule**

- 1st ATF (BNL) testing – Oct 2020, 2nd ATF testing – Dec 2020
- CeC (BNL) installation – Dec 2020
- CeC testing – Feb 2021

Diamond Sensor

- Polycrystalline diamond plate: 46 x 19 x 0.1 mm
- Highly boron doped diamond electrodes:
 - 1 x Horizontal pick-up
 - 10 x Vertical pick-ups

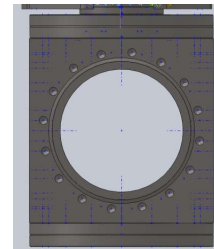
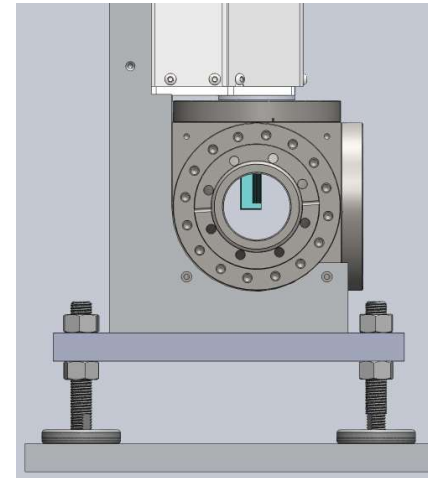

STROK= 0 mm
(fully retracted
diamond)

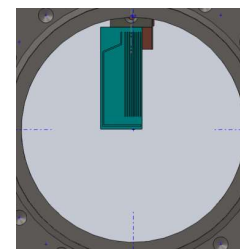

STROK= 52mm
(diamond edge at
the beam center)

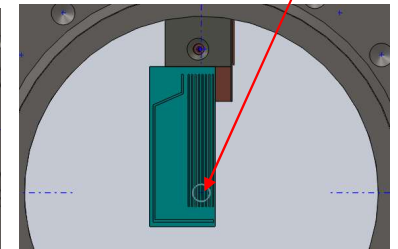

STROK= 61mm
(fully inserted diamond,
return point)

Actuator Tests at UHV-D

- Mag-Coupled drive demonstrated at BNL Oct 2019
 - Magnetic decoupling oscillations observed even without load at high speeds.
- Direct coupled 1m/s version first built & tested by UHV-Design (UK)
 - Extensive testing in Feb-May on request from BNL and Applied Diamond, Inc.
 - Good constant speed over 60 mm observed
 - 0.42% speed variation at 1 m/s

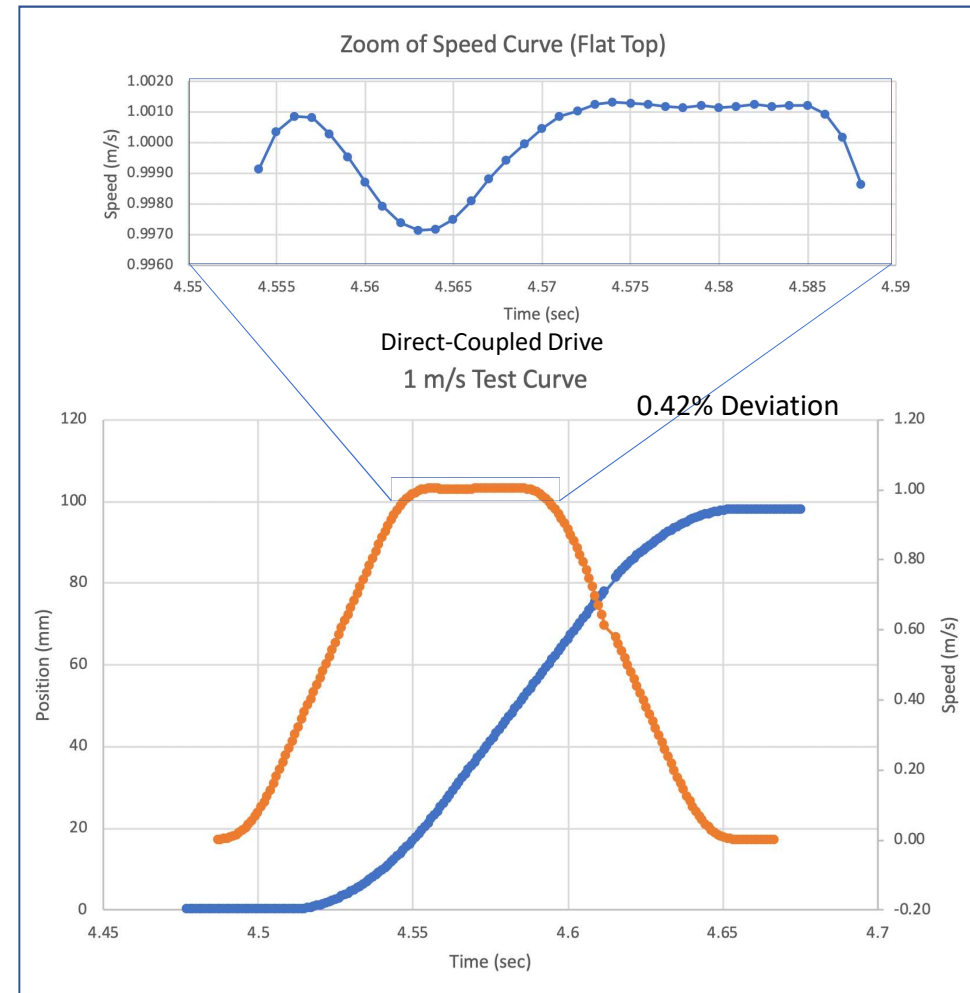
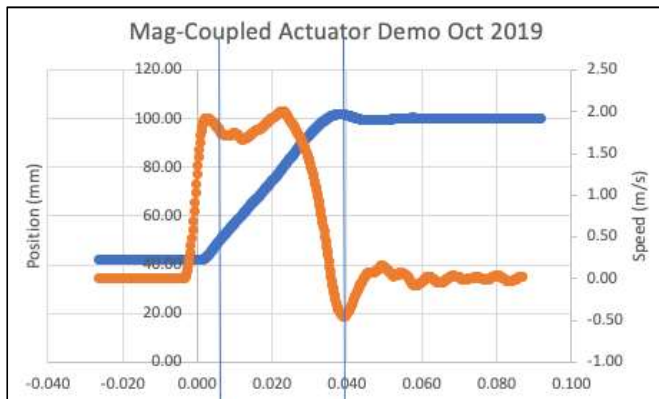

Diamond Detector: Response Testing at ATF Mechanical Installation

- Installed in ATF Beam Line #2 on Oct 14, 2020.
- Electrical response to the beam was tested on Oct 21, 2020

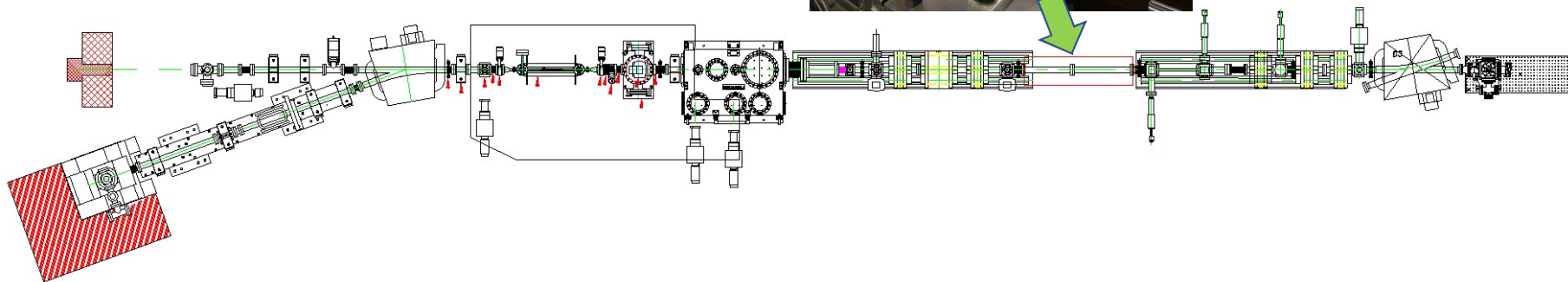
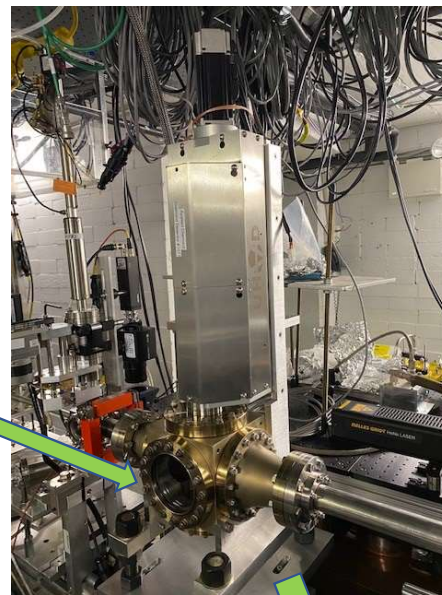
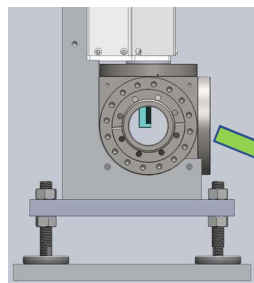

ATF 1st Test Summary

Applied Diamond Inc. evaluated a solid state Diamond Beam Profile Detector with adjustable aperture developed for DOE SBIR award (DE-SC0020498). The detector is designed to be used for high intensity electron beam core profile and halo measurements in the CeC project.

- Diamond Detector was installed into the ATF beam line #2 and successfully pumped.
- Electrical response (transient currents) was measured from 3 conductive strips at several conditions:
 - a. Detector was fully retracted from the beam, partly inserted, and fully inserted into the beam.
 - b. Beam was blocked just before the detector (X-ray only).

Signal Detection

- ATF e-beam: 50 MeV, 1 nC, 20 ps, 1Hz
- Electrical response with e-beam was recorded at three detector positions.
- Transient currents (10-100 pA) from three vertical strips (channels A,B,C) were recorded using the multi-channel electrometer.
- Signal with e-beam was only observed when diamond sensor was fully inserted into the beam. Maximum signals were detected from strip A, small signals from strip B, and no signals from strip C. Likely, unstable signals from strip A were caused by the erratic movement of 1mm diameter beam.
- When e-beam was blocked just before the detector (at ~ 10 cm), generating X-rays, identical signals were observed from all A, B, C strips.

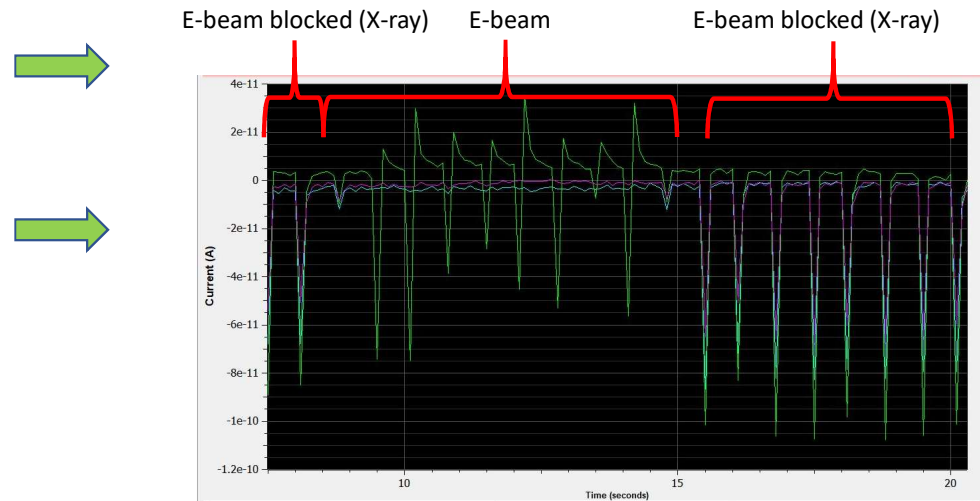
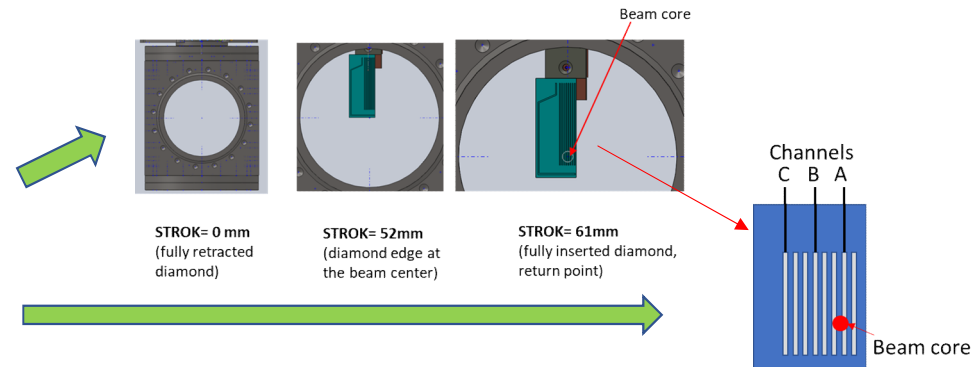

Signal Detection: Beam Horizontal Profile

Beam OFF

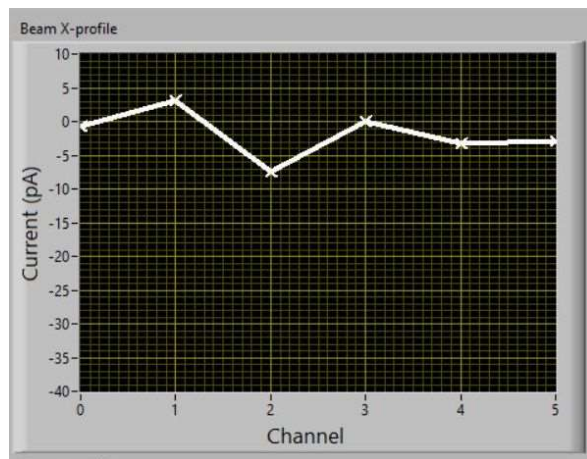

Beam ON

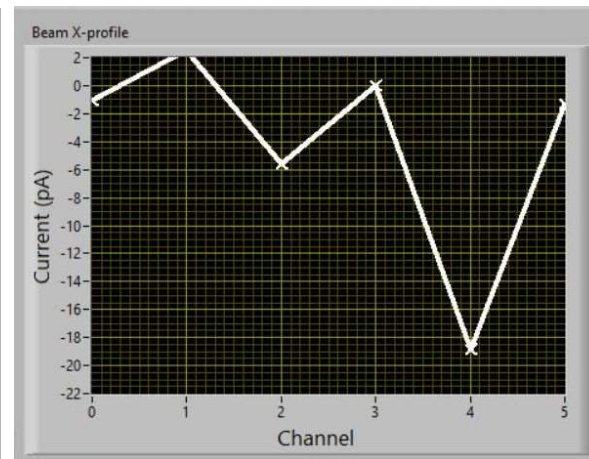

Conclusions from ATF Testing

- Diamond Detector was successfully installed and tested at ATF.
- Testing demonstrated a high sensitivity of diamond sensor to a single electron pulse of 1 nC and horizontal spatial resolution of ~ 0.5 mm.
- High sensitivity (~ 5 pA) proves that the sensor will be able to detect the halo of CW beams far away from the core.
- Horizontal spatial resolution (~ 0.5 mm) is determined by the number of channels. Potentially the resolution can be reduced to ~ 0.1 mm with more strips (channels).
- Vertical spatial resolution will be tested during the 2nd ATF testing in Dec 2020 (currently in progress).
- Ns-pulse detection – to be tested
- Fast Scanning Diamond Detector is ready for installation in CeC.

Activities & Impacts Associated with this Experiment

- Invited Talks:
 - None
- Manuscripts (books, conference and journal articles, other; please include works submitted by not yet accepted):
 - None
- Theses awarded
 - None
- Patents and/or hardware delivered:
 - None
- DOE SBIR 2020 Phase I award, DE-SC0020498

COVID-19 Pandemic Impacts

- Please summarize any significant impacts from COVID-19 on your experiment and team during 2020
 - Delayed several shipments from vendors for about 1-2 months each.